



SMiRT 27

27th International Conference on Structural Mechanics in Reactor Technology

IRID's R&D Results for Fukushima Daiichi Decommissioning and Future Challenges and Expectations

6 March 2024

Toyoaki Yamauchi
**President of International Research Institute for Nuclear
Decommissioning (IRID)**

This achievement is obtained from the subsidy project of Decommissioning and Contaminated Water Management by Ministry of Economy, Trade and Industry (METI).
Prohibiting Unauthorized copy. All right reserved @International Research Institute for Nuclear Decommissioning (IRID)

Roles of Organizations in Decommissioning of Fukushima-Daiichi

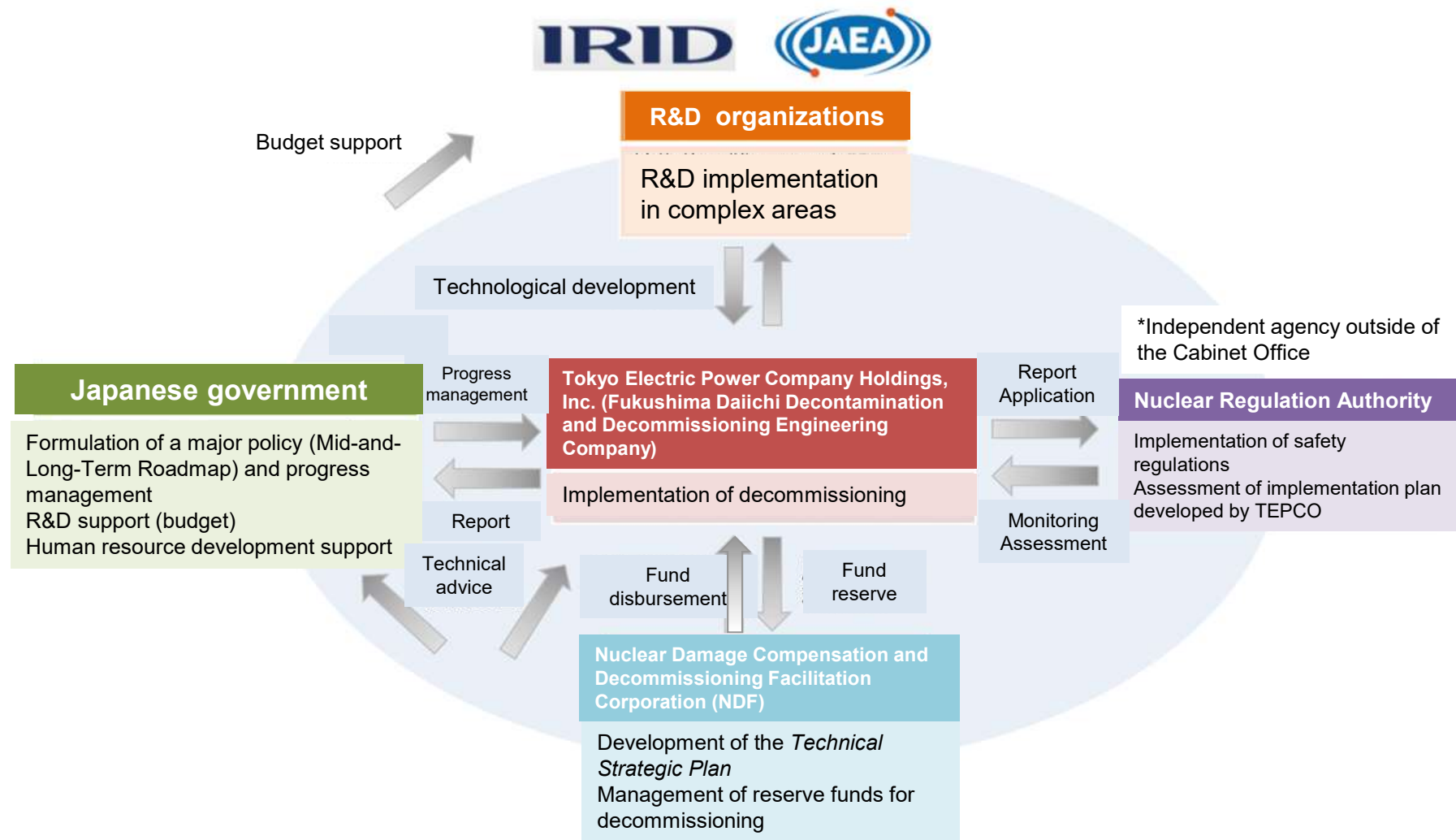

Reference: The Agency of Natural Resources Energy, Ministry of Economy, Trade and Industry of Japan website

Overview of IRID

[Basic principles]

IRID commits to research and development of technology **for the decommissioning of the Fukushima Daiichi Nuclear Power Station as a current urgent issue** from the standpoint of strengthening the foundation of nuclear decommissioning technology

- **Name of organization:** International Research Institute for Nuclear Decommissioning (IRID)
- **Establishment:** August 1, 2013 (approved by the Minister of Economy, Trade and Industry of Japan)

- **Member organizations:** **Number of IRID members: 766 people**
(As on March 31, 2023, excluding directors)

- **Research Institutes: 2 Organizations**
Japan Atomic Energy Agency (JAEA), National Institute of Advanced Industrial Science and Technology (AIST)
- **Manufacturers, etc.: 5 Companies**
TOSHIBA Energy Systems & Solutions Corporation, Hitachi-GE Nuclear Energy, Ltd., Mitsubishi Heavy Industries, Ltd., ATOX Co., Ltd., Tousou Mirai Technology, Co. Ltd.
- **Electric Utilities, etc.: 12 Companies**
Hokkaido Electric Power Co., Inc., Tohoku Electric Power Co., Inc., Tokyo Electric Power Company (TEPCO) Holdings, Chubu Electric Power Co., Inc., Hokuriku Electric Power Company, Kansai Electric Power Co., Inc., The Chugoku Electric Power Co., Inc., Shikoku Electric Power, Incorporated, Kyushu Electric Power Co., Inc., The Japan Atomic Power Company, Electric Power Development Co., Ltd., Japan Nuclear Fuel Ltd.

■ Project costs

Unit: 100 million Yen

Fiscal year	2013	2014	2015	2016	2017	2018	2019	2020	2021	2022
Project costs	46	122	147	143	148	140	142	145	170	155

Progress of IRID's R&D projects

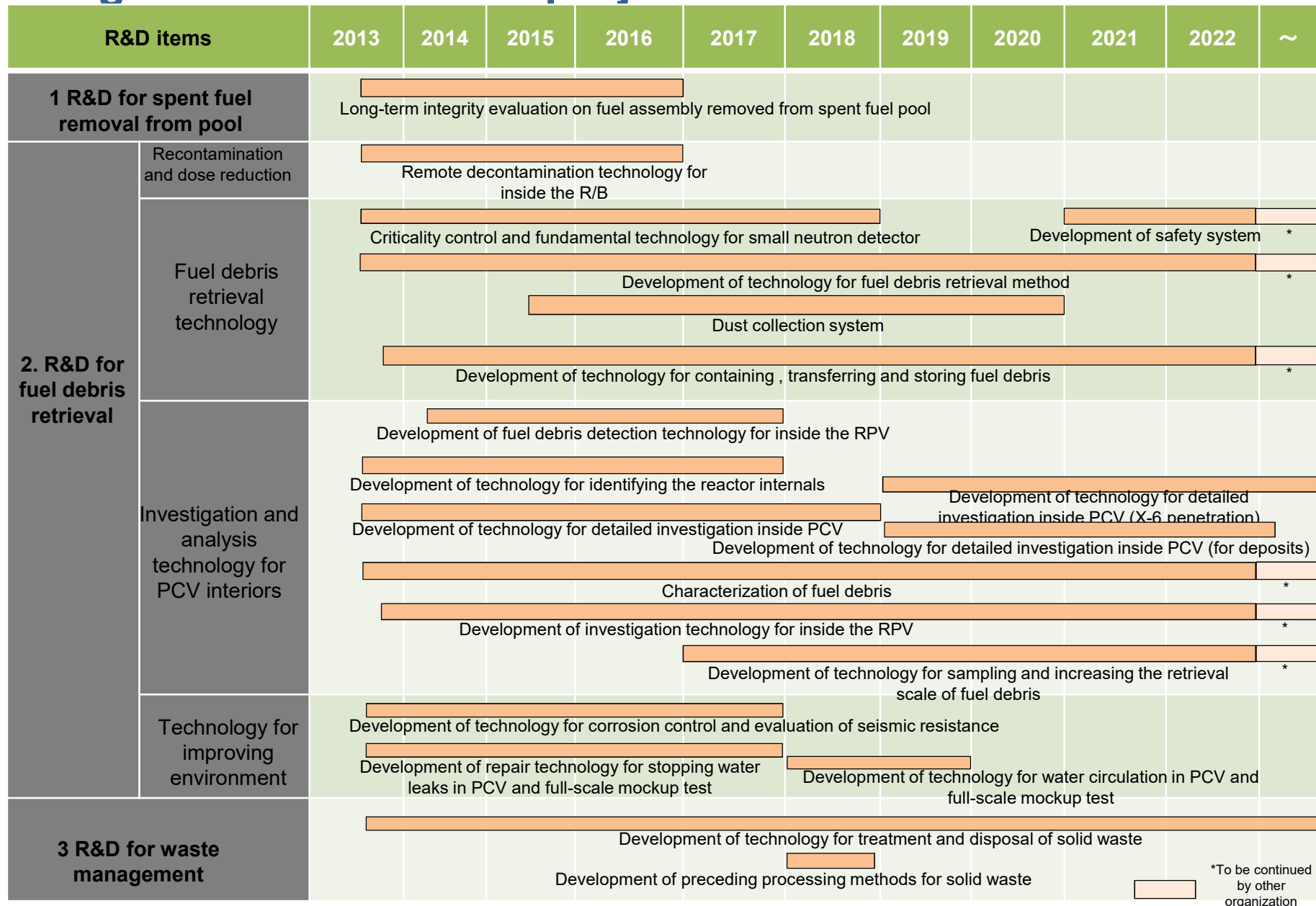

*To be continued by other organization



Technologies for decontamination, dose reduction and environmental improvement (repairing PCV to stop water leaks)

Remote Decontamination Technology

Needs for technological development

Humans cannot access the R/B because radiation levels are high in the R/B. It is necessary **to improve work environments (dose reduction).**

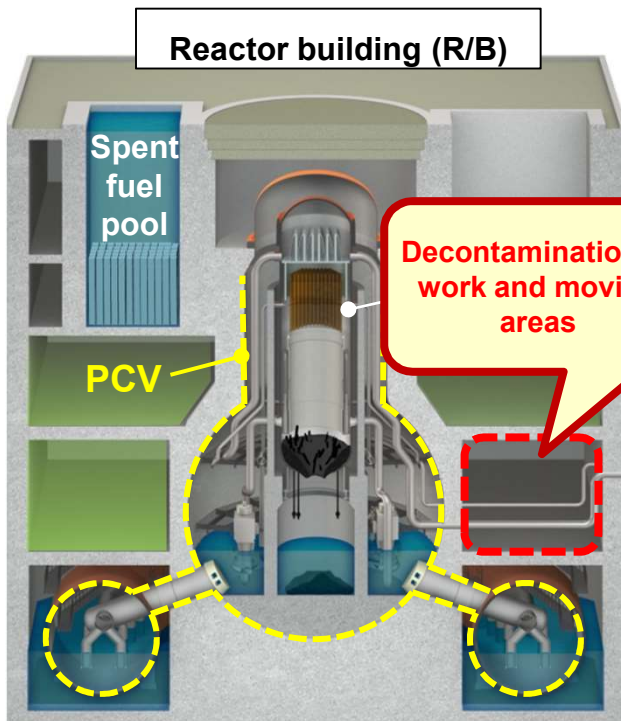

For low places (floors and lower part of walls)



Suction and blast



High pressure water injection



Dry ice blast

For high places

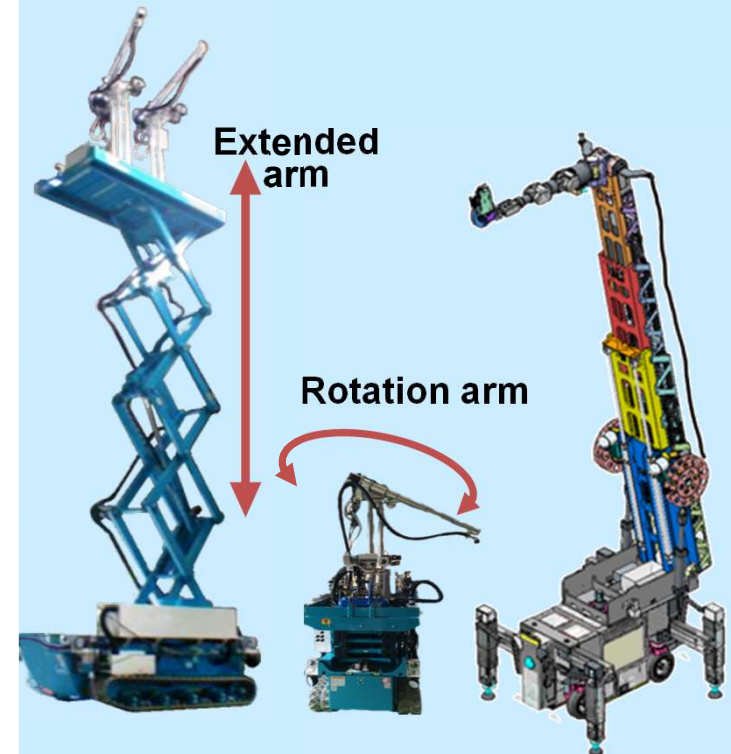

For upper floors

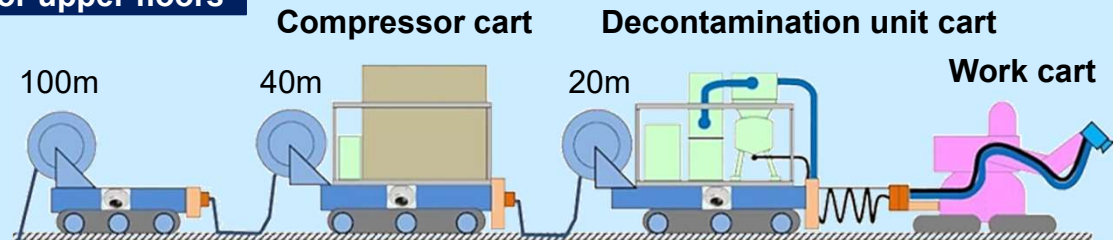

Technology for repairing the primary containment vessel (PCV) and stopping water leaks

Test for stopping water leaks in vent pipe

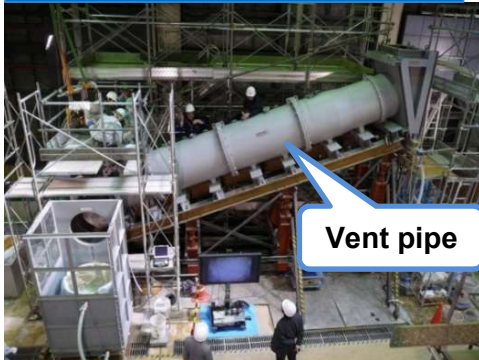

Vent pipe

Performance of water stops was confirmed by using the 1/2 scale test facility (in-factory test).

Test for stopping water leaks using plug material



Plug material

Performance of water stops using a plug material was confirmed by using the 1/2 scale facility (outdoor test).

:Area for repairing PCV and stopping water leaks

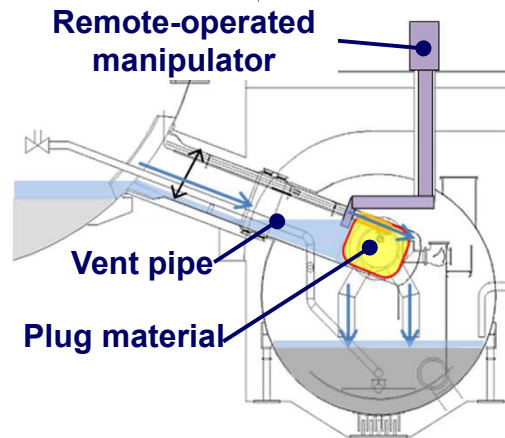
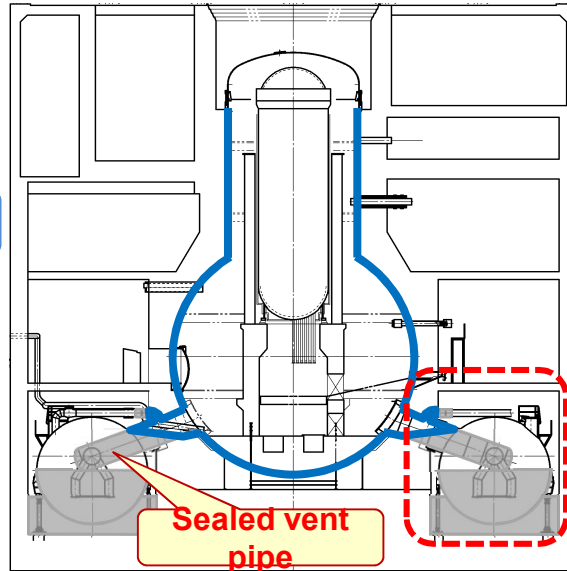

Test using a full-scale test facility

Full-scale test facility (1 / 8 sector)

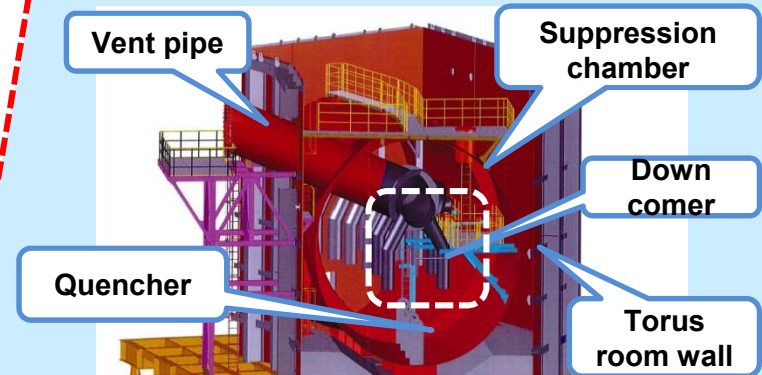

The test facility was built in the JAEA Naraha Center for Remote Technology Development.

Work floor

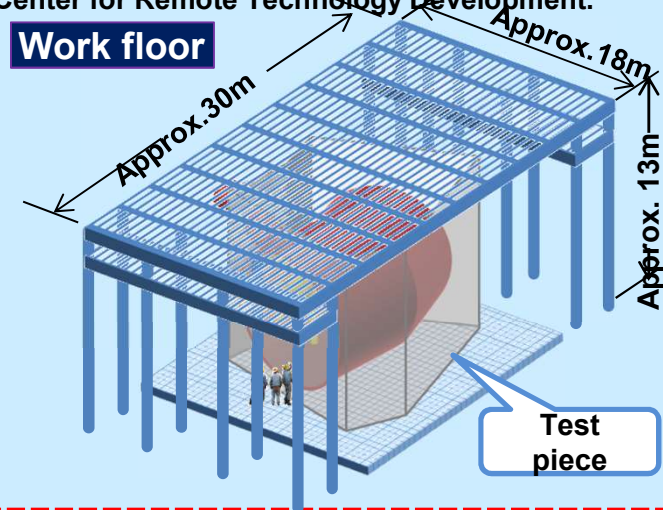



Investigation technology for inside the PCV* and investigation results

*PCV: Primary containment vessel

Muon transmission measurement to identify the location of fuel debris

- Muons are secondary cosmic rays, which generate when radiation from space collides with the atmosphere of the Earth. The cosmic ray muons are high-energy particles and can pass through materials.
- Muon tomography can measure the number of muons that pass through the reactor building to image the density of materials such as X-ray. It can be used to image the distribution of fuel debris in the reactor pressure vessel (RPV). (Smaller number of muons will pass through high density regions so higher density regions show dark shadow).

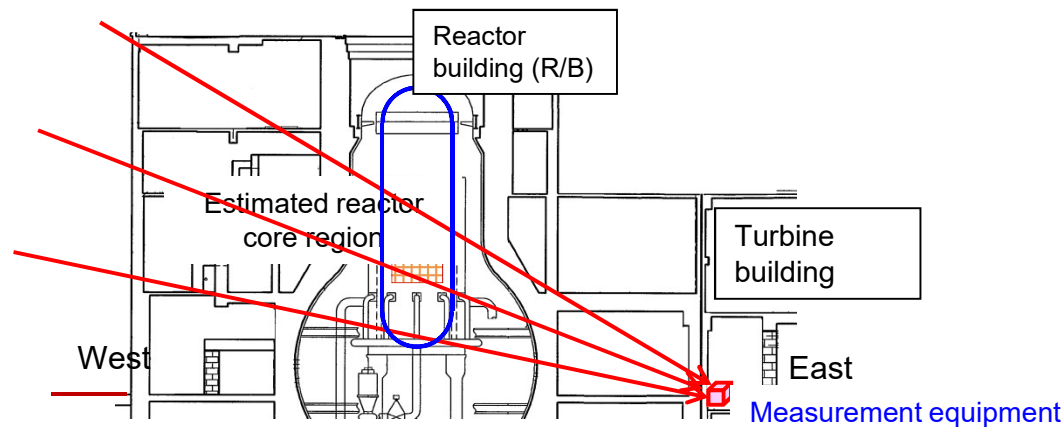

Illustration of measuring muons passing through the reactor building (horizontal cross section)

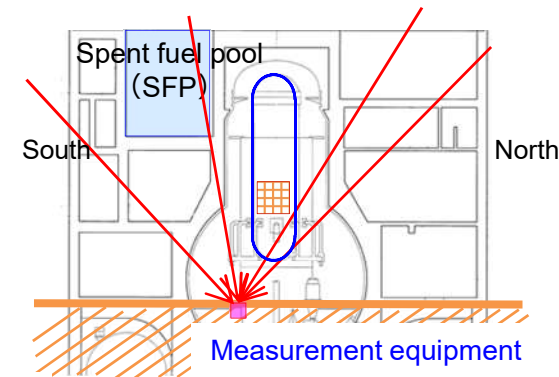
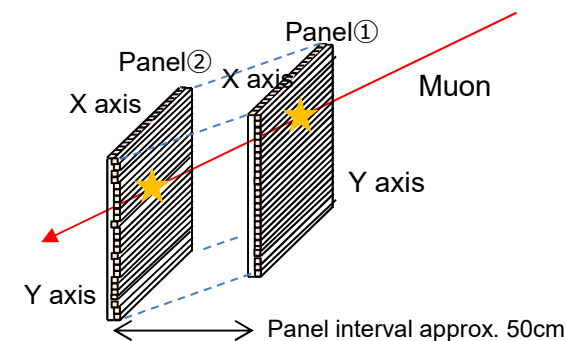

Illustration of measuring muons passing through the reactor building (vertical cross section)

<Measurement principle of the muon transmission method (illustration)>

Two panel detectors (plastic scintillator) that are placed in the measurement equipment can detect muons falling from space and calculate their trace on where they have passed through from the coordinates (X and Y axes) on the panel.



Measurement results of the muon transmission method (2014 - 2017)

No high-density substances were confirmed in the core region of the Fukushima Daiichi Units 1-3.

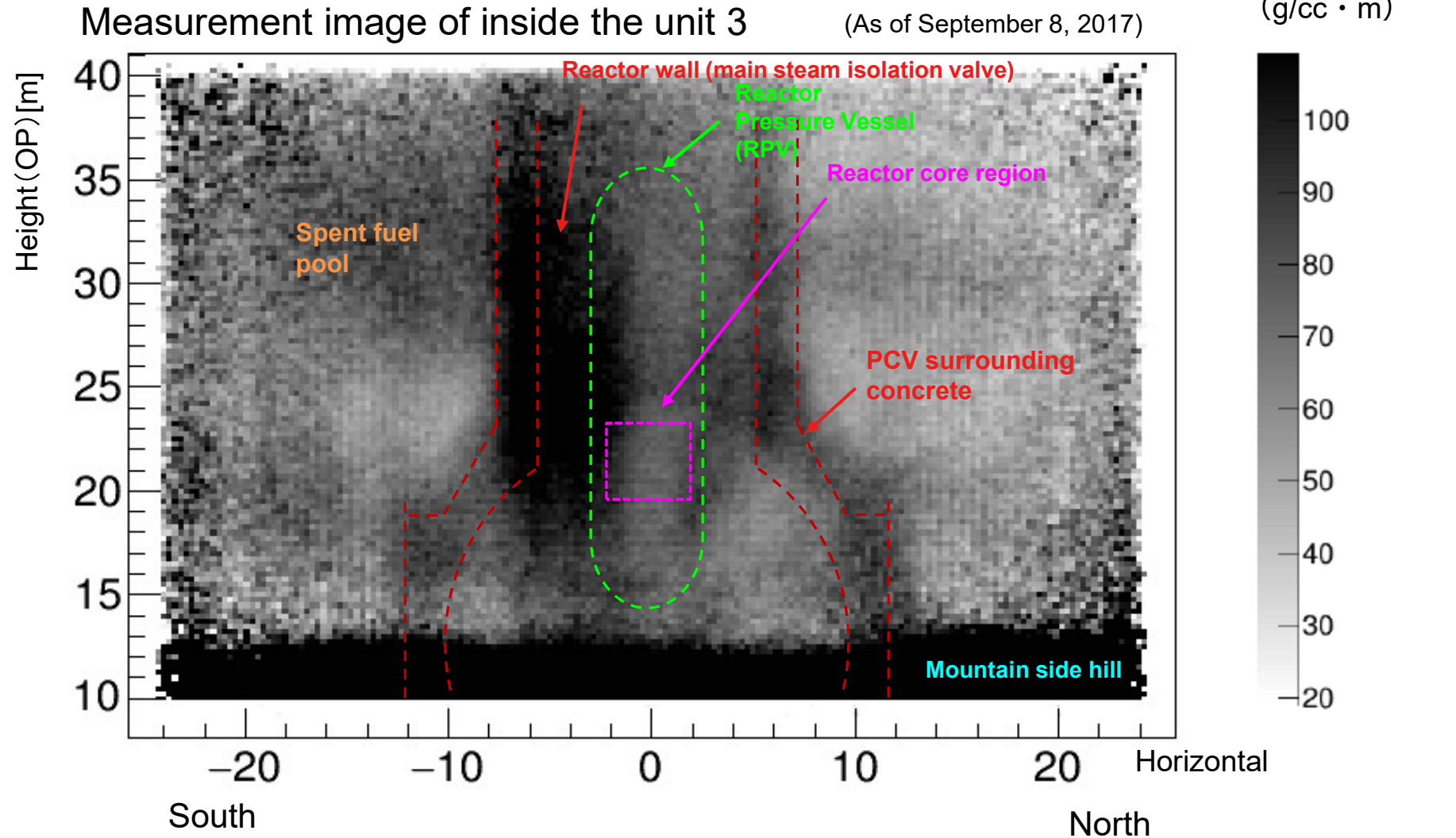

Robots developed for investigation of PCV interiors

Investigation of outside the pedestal (Unit 1)

- Shape-changing robot (B2 investigation)

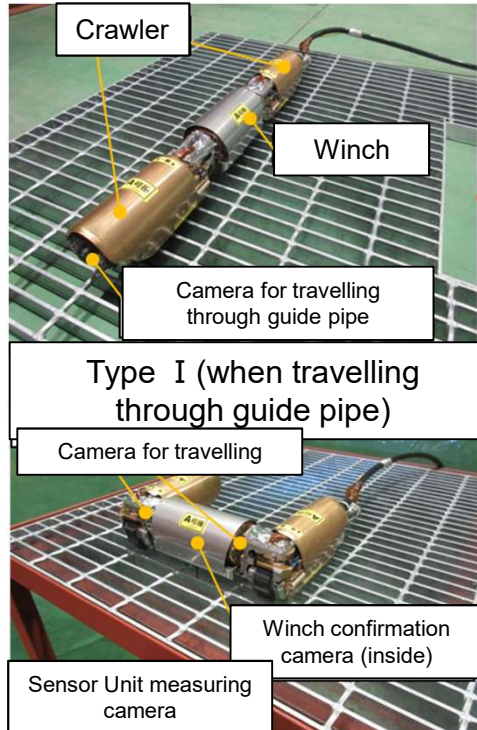

Investigation of inside the pedestal (Unit 2)

- Crawler type remote-operated investigation robot (A2 investigation)

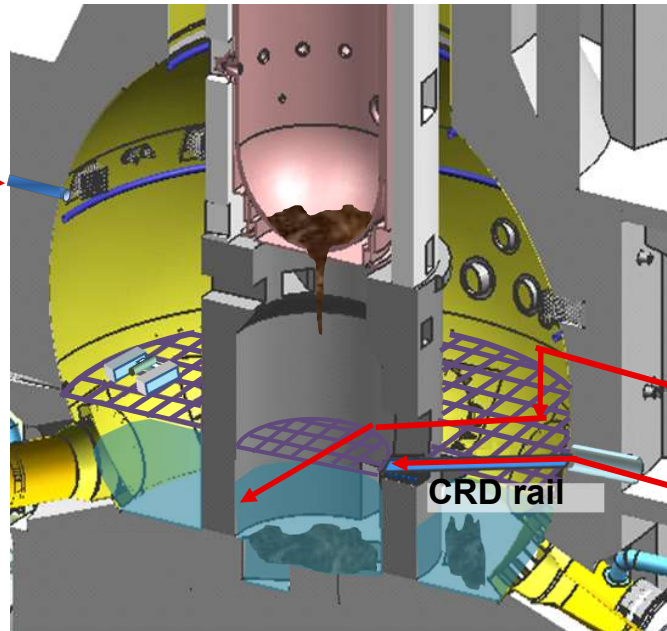

- Suspension type investigation equipment (A2' investigation)

Investigation of inside the pedestal (Unit 3)

Investigation of inside the pedestal (Unit 1)

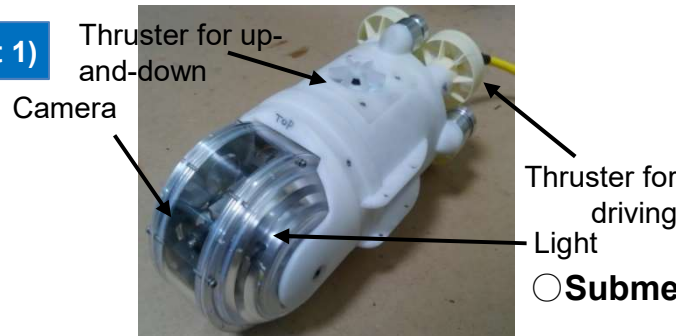
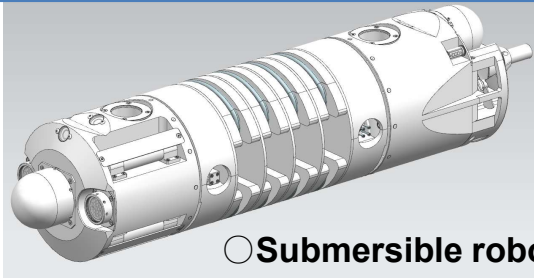

- Submersible robot



Investigation results of the Unit 2 lower pedestal interior

(A2' investigation on Jan.2018)

Photo: Near the pedestal inner wall
at the Unit 2 PCV bottom

(A fuel assembly handle was found.)

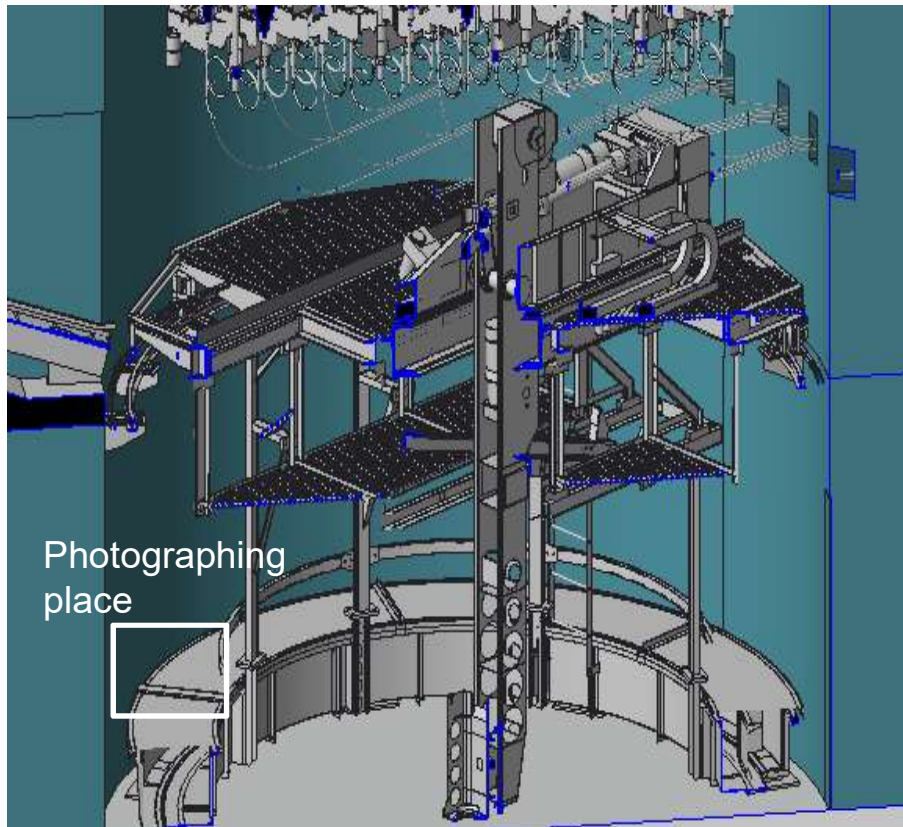

The Unit 2 PCV bottom
(An overhead view)



Reference: The TEPCO Holding Inc. website.

Investigation results of the Unit 2 upper pedestal interior

(A2 investigation: January – February 2017)

Upper pedestal interior (after image processing)

VIEWING ANGLE : 90

ImageList:

ImageIndex:



Reference: The TEPCO Holding Inc. website.

Investigation results of the Unit 3 PCV interior (in July 2017)

2. Investigation results

2.3. The lower pedestal

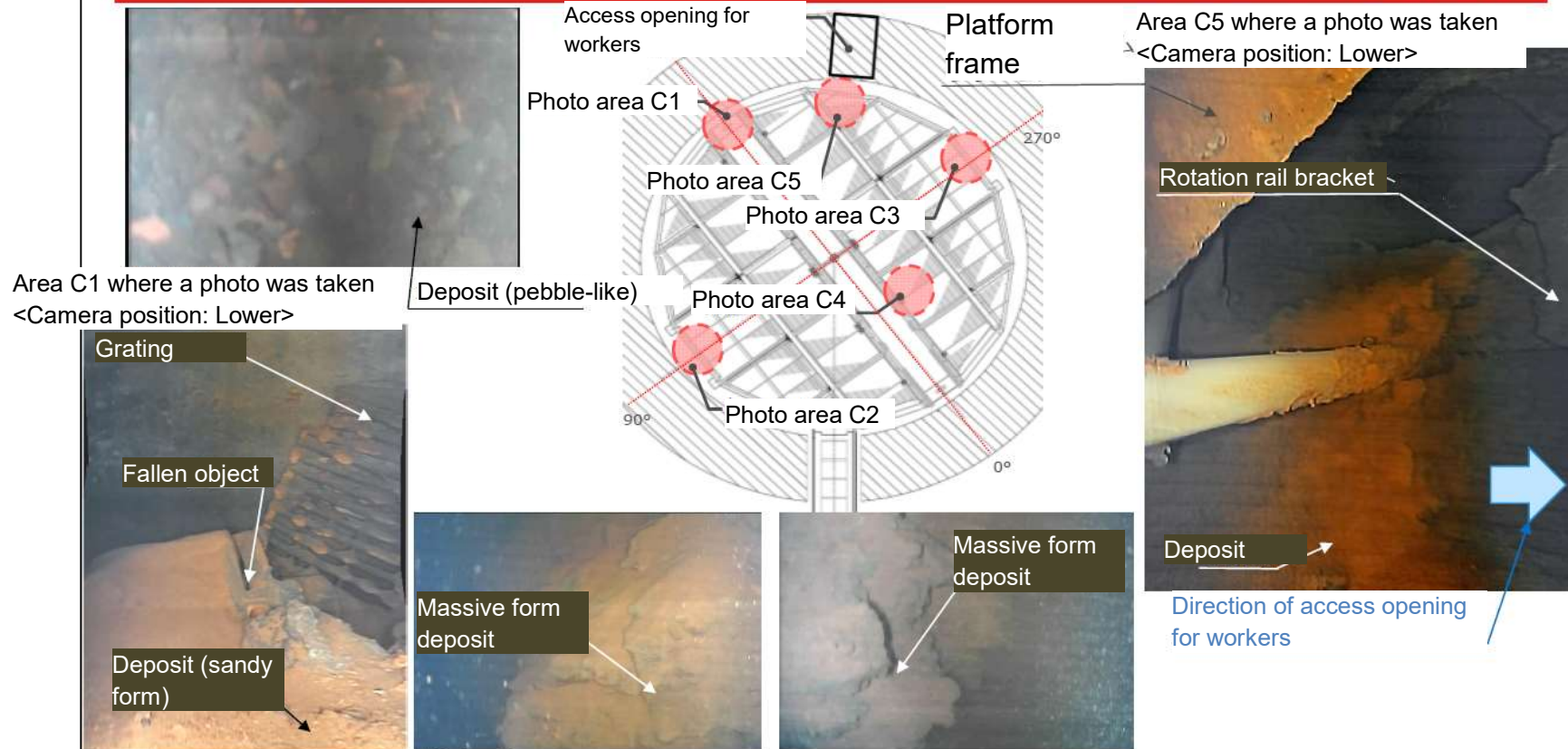

Area C1 where a photo was taken
<Camera position: Lower>

Deposit (pebble-like)

Grating
Fallen object
Deposit (sandy form)

Massive form deposit

Massive form deposit

Area C5 where a photo was taken
<Camera position: Lower>

Rotation rail bracket
Deposit
Direction of access opening for workers

Area C2 where a photo was taken
<Camera position: Horizontal>

Area C3 where a photo was taken
<Camera position: Upper>

Area C4 where a photo was taken
<Camera position: Lower>

- The investigation has revealed that deposits in sandy, pebble-like and massive form has accumulated.
- The access opening for workers was not confirmed visually (Deposits were found nearby the pedestal).

Investigation results of the Unit 1 pedestal interior

A panoramic view of the pedestal interior
(image processing by TEPCO HD)

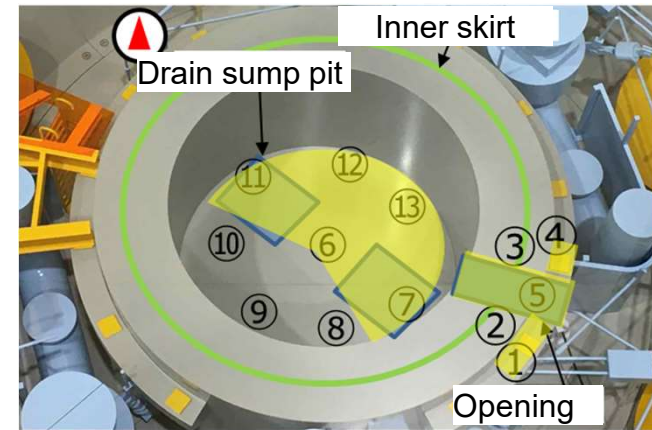



Technological development for fuel debris retrieval

Development and demonstration of the robot arm

- The arm type access equipment was manufactured which can access on a wide range through the PCV penetration for maintenance of a control rod drive mechanism.
 - Total length of the arm: Approx. 22m
 - Investigation equipment up to 10kg can be loaded.

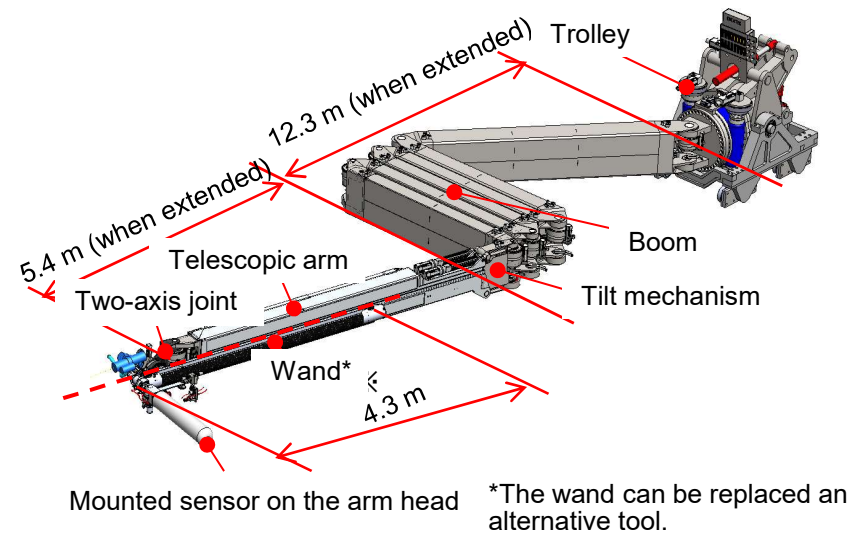

Demonstration test at the JAEA Naraha Center for Remote Technology Development

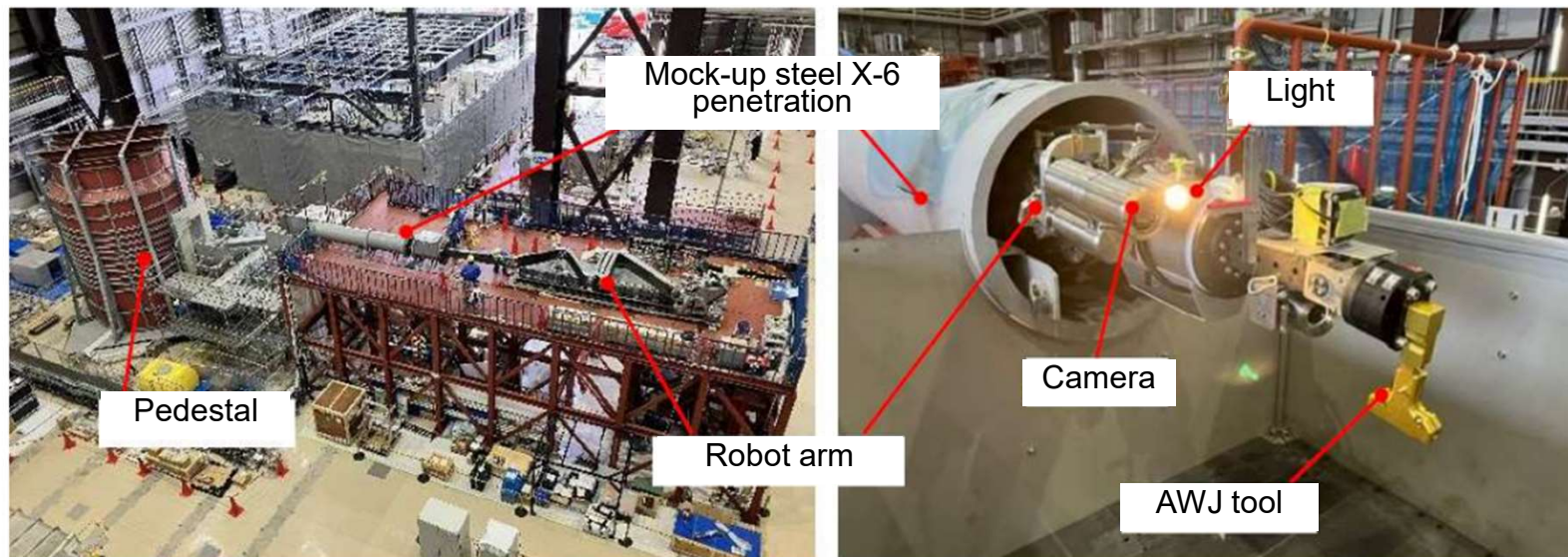

Reference: Report of the preparation status of investigation inside the Unit 2 PCV and trial retrieval of fuel debris issued by the Team Meeting and Countermeasures for Decommissioning and Contaminated Water Treatment Conference (the 115th).

Hatch opening of the Unit 2 PCV penetration

■ Opening of the PCV penetration (X-6 penetration)

Technology for opening the X-6 penetration was developed to insert the arm type access equipment.

- ✓ **Confinement functions when opening the hatch**
- ✓ **Hatch opening by remote operation**

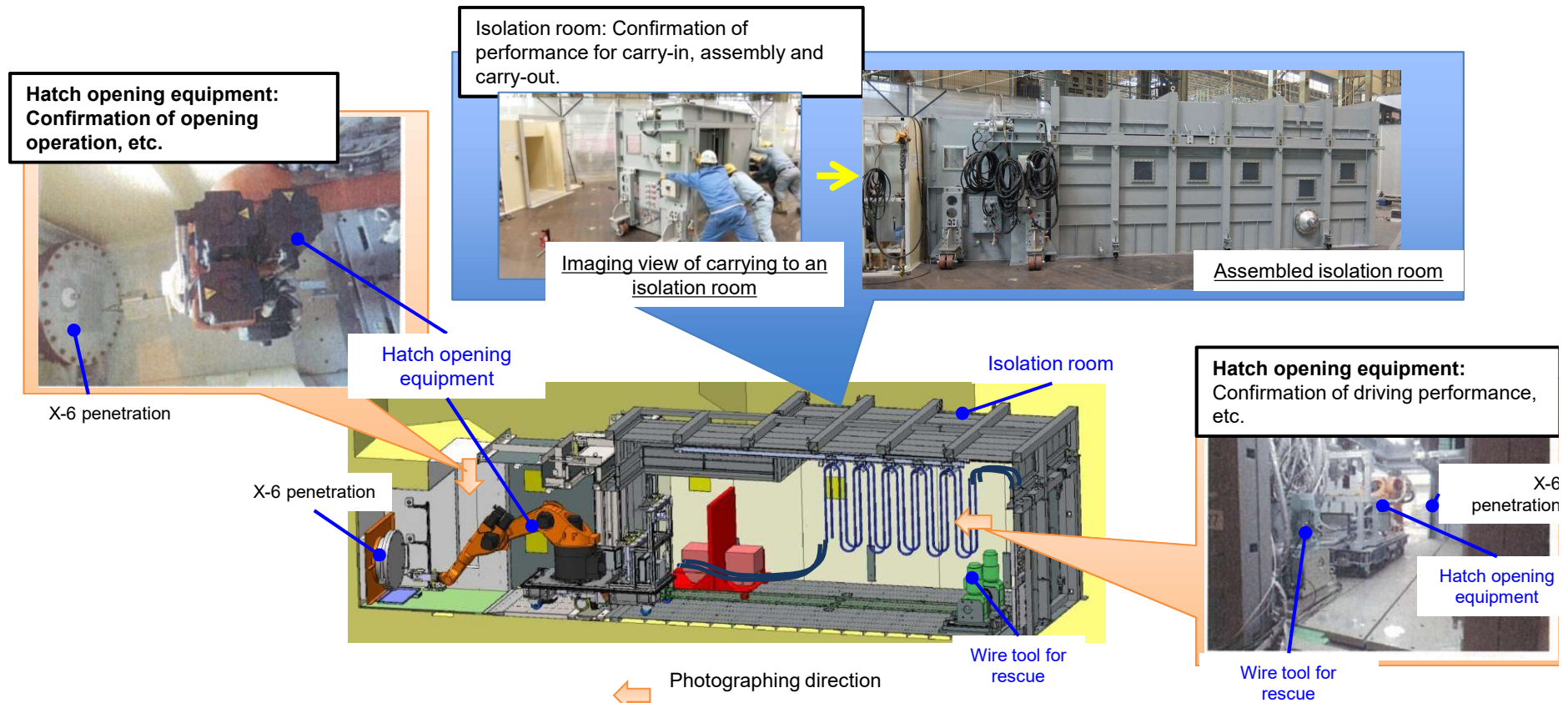

Access route of fuel debris retrieval for the Unit 2



X-6 Penetration Before Cleaning

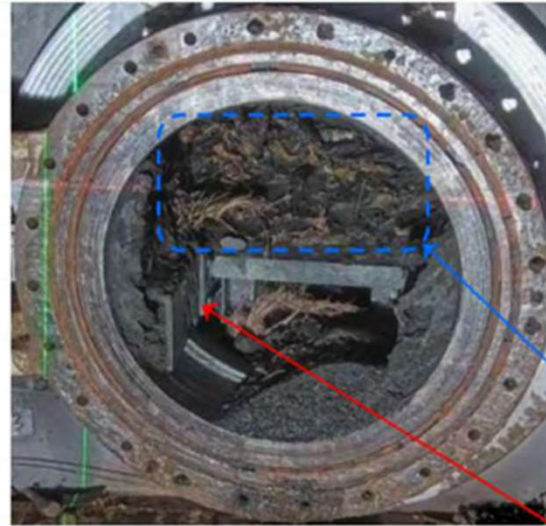
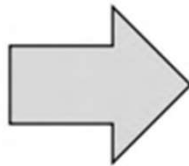

After Cleaning by low-pressure water ①

Cables etc

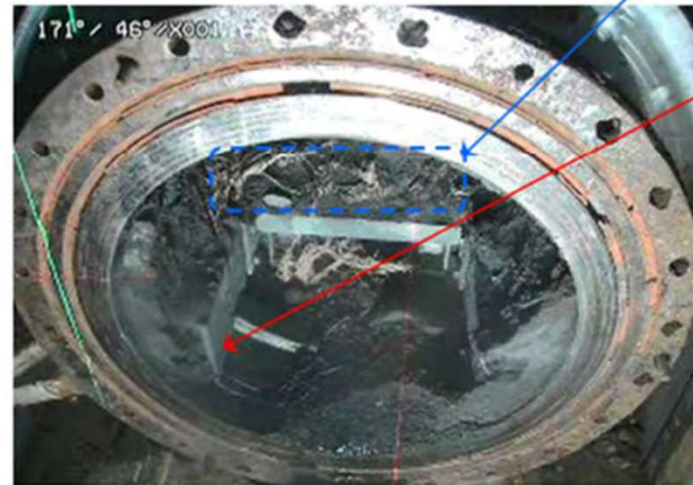

After Cleaning by low-pressure water ②

CRD rail





Technology for waste management

Waste characterization : Analysis and database establishment

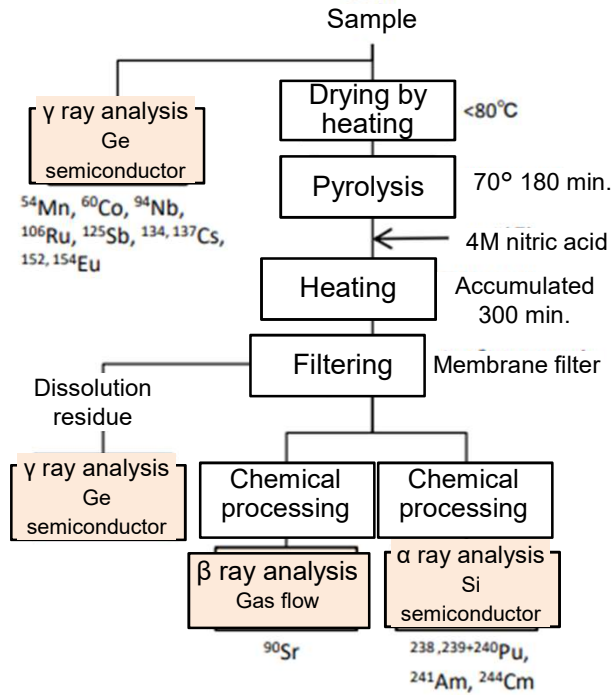

KURION



Sample collection equipment

FRAnDLi (Fukushima Daiichi Radwaste Analytical Data Library)

<https://frandli-db.jaea.go.jp/FRAnDLi/>

Debris-Wiki

The Debris-Wiki is a simple data interface to narrow the search from classification of waste and analysis items. It is easy to use for beginners. The Japan Atomic Energy Agency (JAEA) has developed the wiki-style database platform.

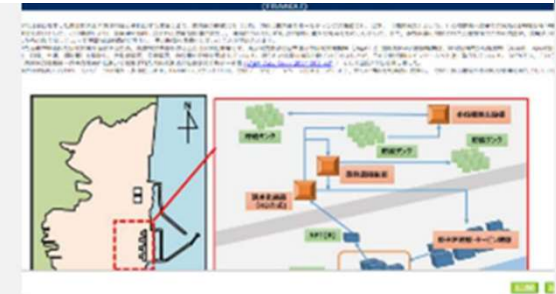

The FRAnDLi top page and search performance

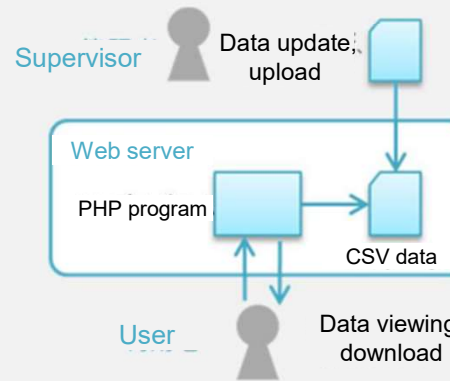

Configuration and functions of FRAnDLi

Technology for storing and handling high level radioactive waste



Contamination measurement by using α camera

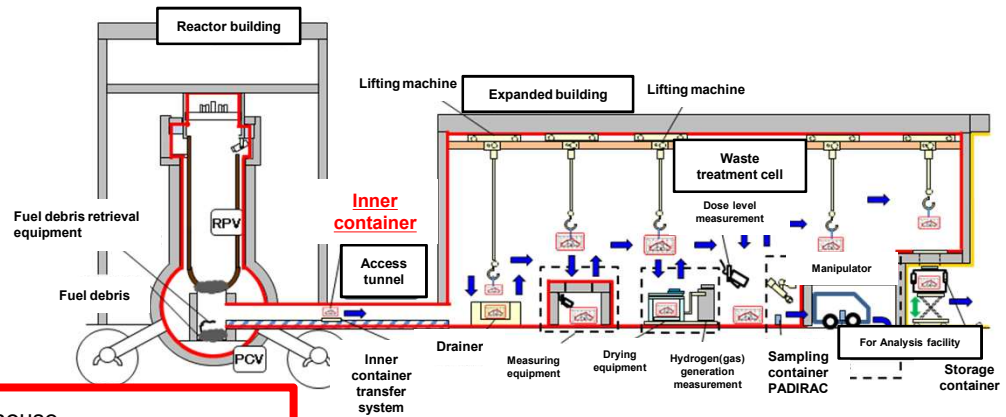

Process flow from retrieving fuel debris to storing it (excerpt)

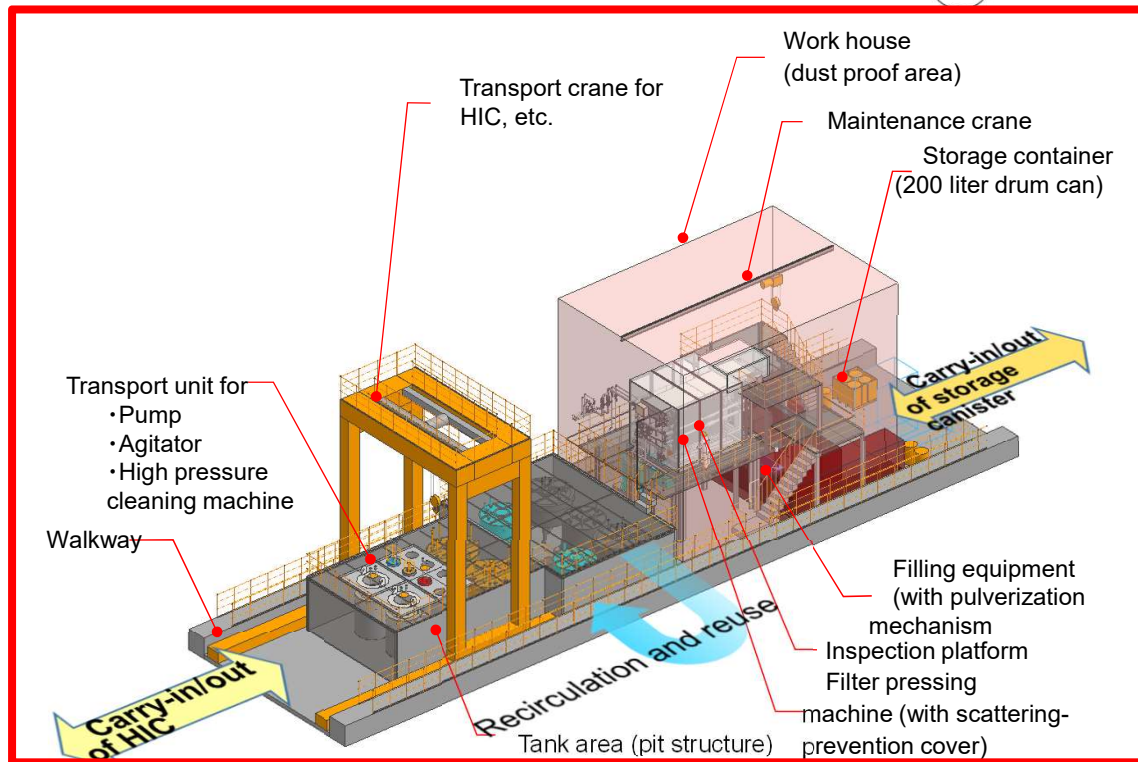
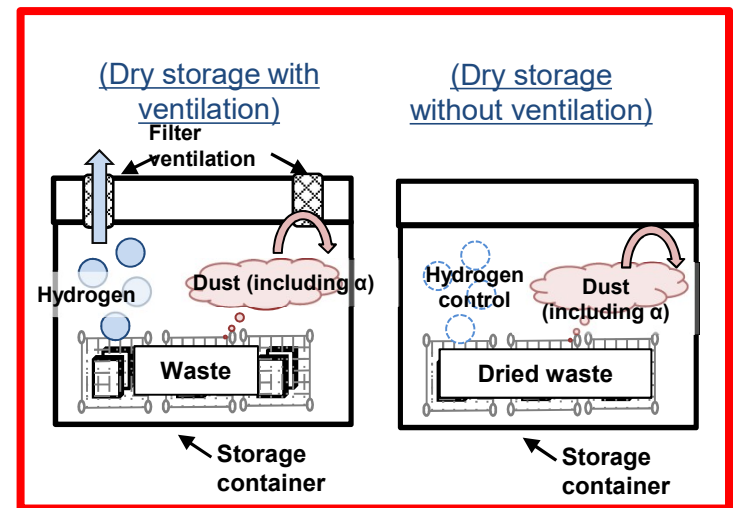

Illustration of pressurized compression filtering method system



Example of storing high level radioactive waste in Japan (illustration of storage methods)



Summary

Summary of the investigation results until now (Unit 1)

- Unit 1 has almost no fuel in the RPV, and deposits have spread outside the pedestal. The inner walls of the pedestal were also damaged.
(The Unit 1 reactor core was damaged about eight hours after the loss of power.)



Composite image of the Unit 1 entire pedestal floor
(Reference: the TEPCO Holdings website)



Shelf-shaped deposit
outside the Unit 1 pedestal
(Reference: TEPCO Holdings
website)

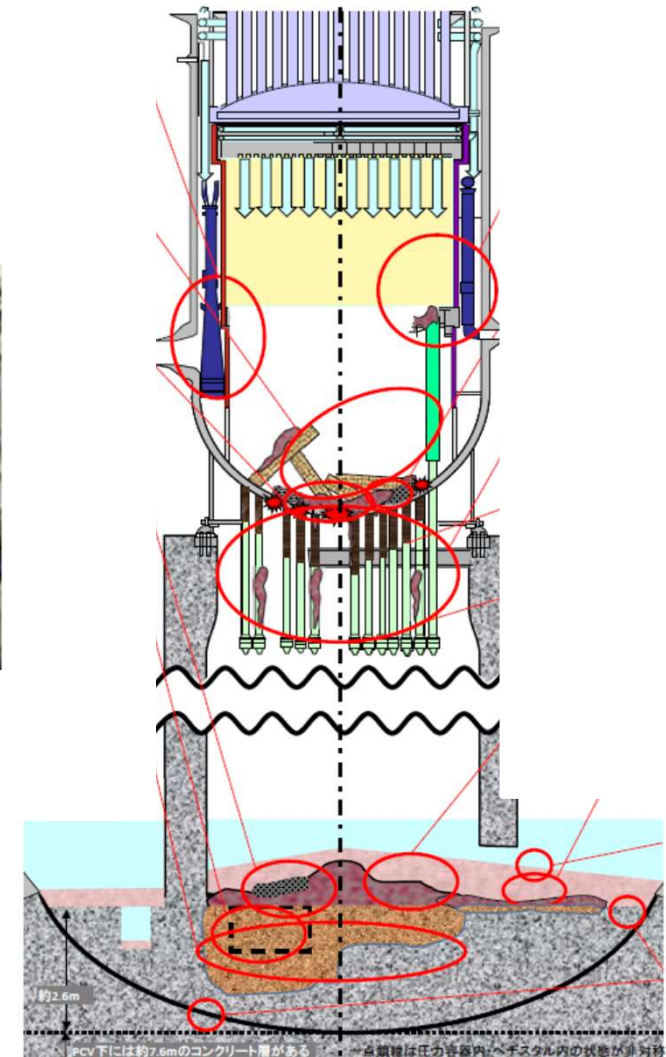

Damage estimation of the Unit 1 RPV/PCV
(From TEPCO website)

Summary of the investigation results until now (Unit 2)

- Unit 2 has a lot of fuel left in the reactor pressure vessel (RPV). Although there is 1 meter-deposit on the pedestal floor. The RPV substructure retains its original form.
(The Unit 2 reactor core was damaged about 3 days after the loss of power.)

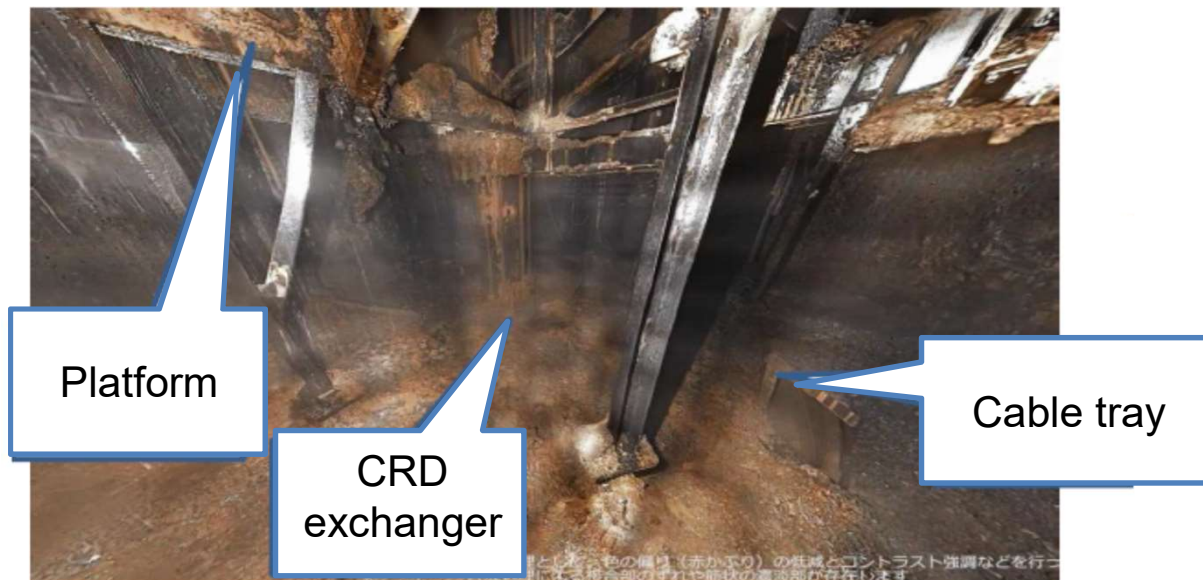

Wide angle photo of the Unit 2 entire pedestal floor
(Reference: the TEPCO Holdings website)

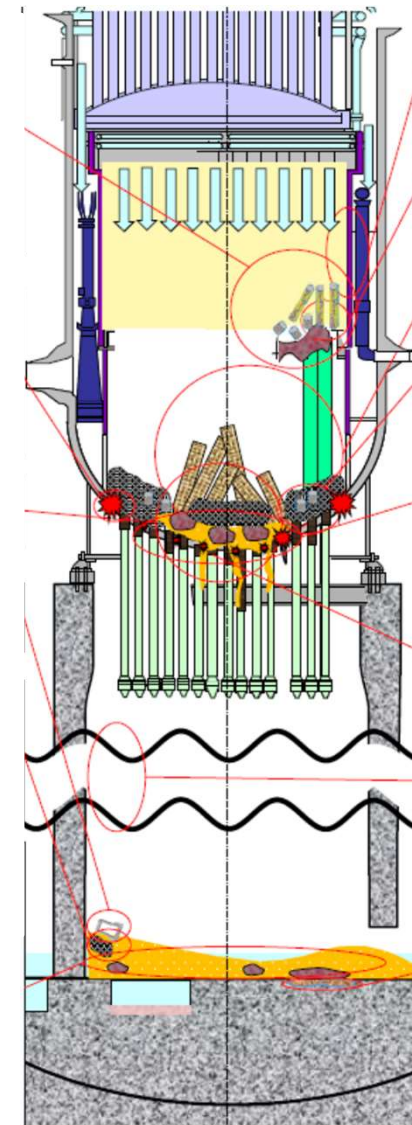

Damage estimation of the Unit 2 RPV/PCV
(From TEPCO HP)

Summary of the investigation results until now (Unit 3)

- Unit 3 has some fuel left in the RPV. There is 2-3 meters of deposits on the pedestal floor.
(The Unit 3 reactor core was damaged about one and half day after the loss of power.)

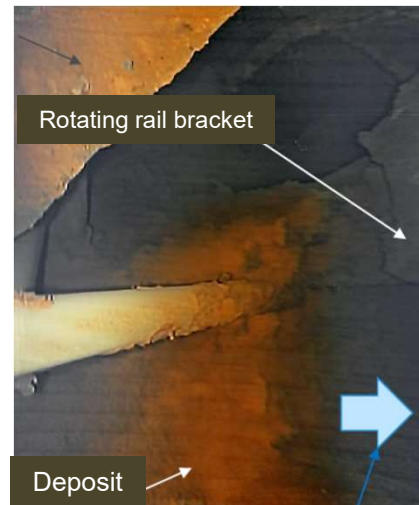

Photos taken from investigation inside the Unit 3 pedestal

(Reference: the TEPCO Holdings website)

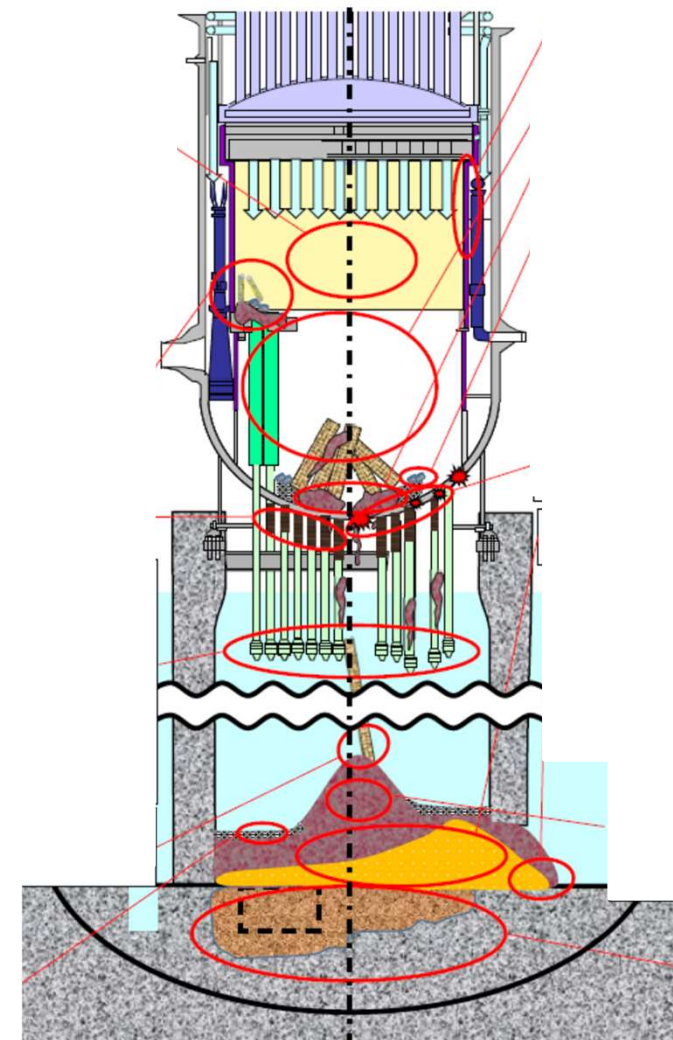

Damage estimation of the Unit 3 RPV/PCV
(From TEPCO HP)

Future Challenges and Expectations

- IRID has been conducting research and development for the investigation of inside the PCVs. The results of R&D revealed that the situation of inside the PCVs was clarified by photography taken by camera.
- Further investigation and clarification of the accident occurrence are needed to develop the future plan and to proceed with engineering for the decommissioning.
- We will continue working together for the decommissioning of the Fukushima Daiichi by sharing knowledge and experience with relevant parties from Japan and overseas.
- Clarification of the accident occurrence would be useful for responding to an accident during operating reactors and designing the safety system for new reactors. We will continue sharing these useful information with the world to contribute the safety of the nuclear power plant.

Thank you for the attention.

IRID's R&D reports are available on the following IRID website.

<https://irid.or.jp/en/research/>

A booklet *“The 10-year path of research development for the decommissioning”* was released in July 2023.

*Only Japanese version is available.

