

Subsidy Project of Decommissioning and Contaminated Water
Management in FY 2016 Supplementary Budget

Upgrading of Fundamental Technology for Retrieval of Fuel Debris and Internal Structures

FY2018 Final Report

July 2019

International Research Institute for Nuclear Decommissioning (IRID)

Contents

1. Purpose and Goal of *Upgrading of Fundamental Technology for Retrieval of Fuel Debris and Internal Structures*
2. Achievements of Projects Implemented in FY2015 to FY2016
3. Project Overview
4. Implementation Schedule and System of This Project
5. Details of Subsidized Projects
6. Implementation Details of This Project
 - 1) Development of Technology for Prevention of Fuel Debris Spreading
 - (1) Development of Fuel Debris Collection System
 - (2) Development of Fuel Debris Cutting / Dust Collection System
 - (3) Development of Prevention Method of Fuel Debris Spreading
 - 2) Development of Element Technology for Retrieval Device Installation
 - (1) Development of Element Technology for Work Cells
 - (2) Development of Interference Object Removal during Fuel Debris Retrieval
 - 3) Development of Remote Maintenance Technology for Fuel Debris Retrieval Device
7. Summary
8. Specific Goals for Achieving the Purposes of the Project

1. Purpose and Goal of *Upgrading of Fundamental Technology for Retrieval of Fuel Debris and Internal Structures*

[Purpose of *Upgrading of Fundamental Technology for Retrieval of Fuel Debris and Internal Structures*]

Investigations to date suggest that nuclear fuel, melted down with reactor internals, formed fuel debris and accumulated in the Reactor Pressure Vessel (RPV) and the Primary Containment Vessel (PCV) at the Fukushima Daiichi Nuclear Power Station (NPS).

The fuel debris in the RPV and PCV is currently assumed to be in a sub-critical state. Nevertheless, the entire nuclear power plant is in a condition different from the original design and is unstable due to damages on the reactor building, RPV, and PCV caused by the accident. It is therefore necessary to stabilize the plant by retrieving the fuel debris and maintaining it in a sub-critical state, as well as preventing the diffusion of radioactive materials.

Given the above-mentioned circumstances, the project's goal is to begin fuel debris retrieval by 2021 or earlier from any of the units chosen as the first target of this work. Relevant studies will be conducted based on the *Mid-and-Long-Term Roadmap towards the Decommissioning of Tokyo Electric Power Company's (TEPCO's) Fukushima Daiichi NPS Units 1-4* (hereinafter Mid-and-Long-Term Roadmap).

The project objectives are: to facilitate the smooth decommissioning and contaminated water treatment of TEPCO Holding's Fukushima Daiichi NPS by supporting the development of necessary technologies according to the Mid-and-Long-Term Roadmap, as well as the *Progress status of R&D projects and direction for next period* (the 39th secretariat meeting of the Team for Countermeasures for Decommissioning and Contaminated Water Treatment) and to improve the level of science and technology in Japan.

Specifically, technologies to realize methods and devices used to remove fuel debris and reactor internals will be developed, to support the selection and use of methods and devices for fuel debris and reactor internals retrieval. Focus will be given on top access and side access methods in the technical development of fuel debris retrieval methods.

[Overall development goal]

The project will be executed with the aim of commencing large-scale fuel debris retrieval.

2. Achievements of Projects Implemented in FY2015 to FY2016

Application examples of developed basic and fundamental technology (1/3)

Examples of method



- Tests on platforms and cells



- Tests on RPV access device



- Fuel debris cutting and dust collection technology

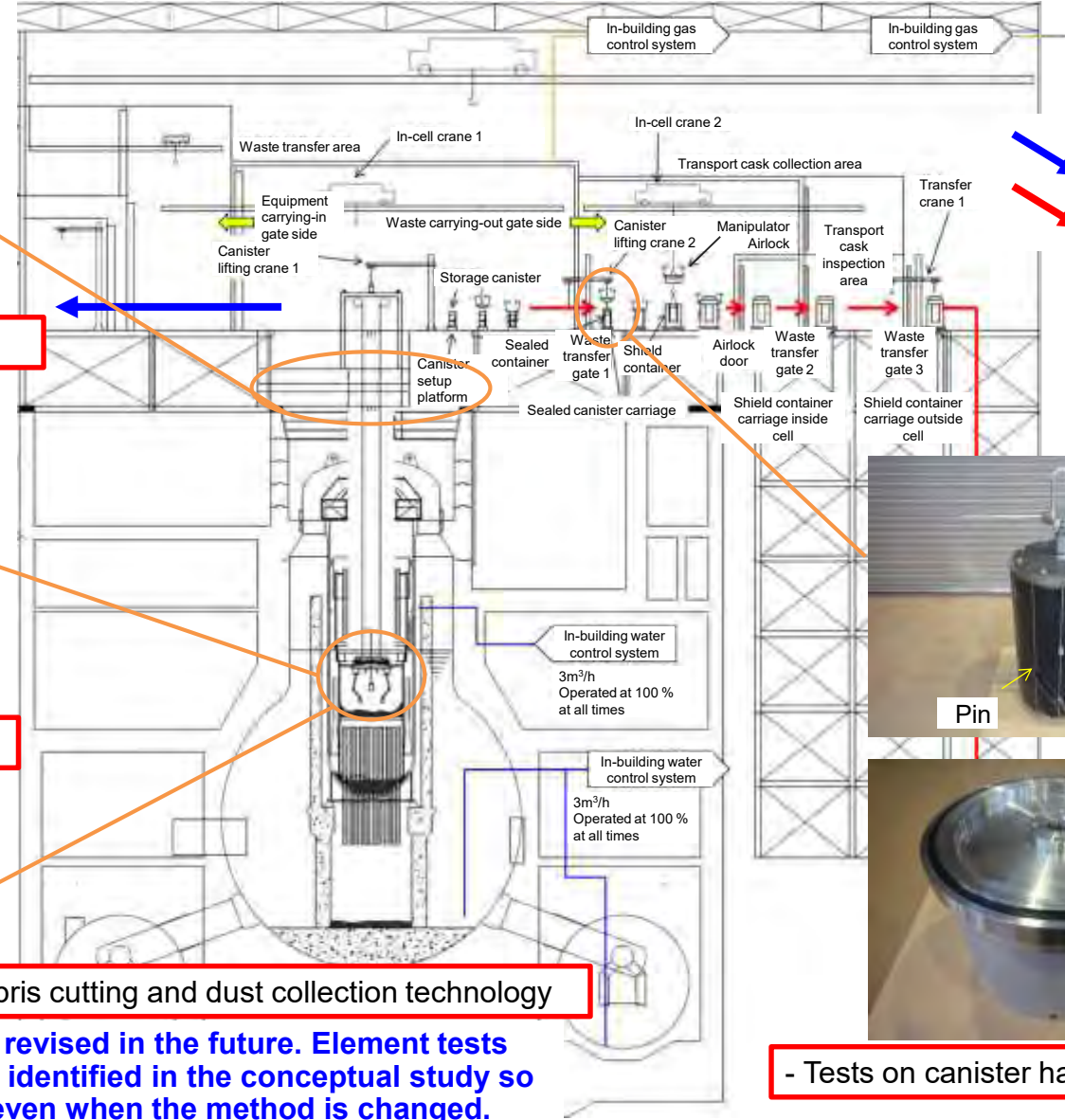

Blue arrow : Device traffic line
Red arrow : Fuel debris flow line



- Tests on canister handling equipment

This is only an example and may be revised in the future. Element tests were conducted on technical issues identified in the conceptual study so that the technology can be applied even when the method is changed.

2. Achievements of Projects Implemented in FY2015 to FY2016

Application examples of developed basic and fundamental technology (2/3)

No.4

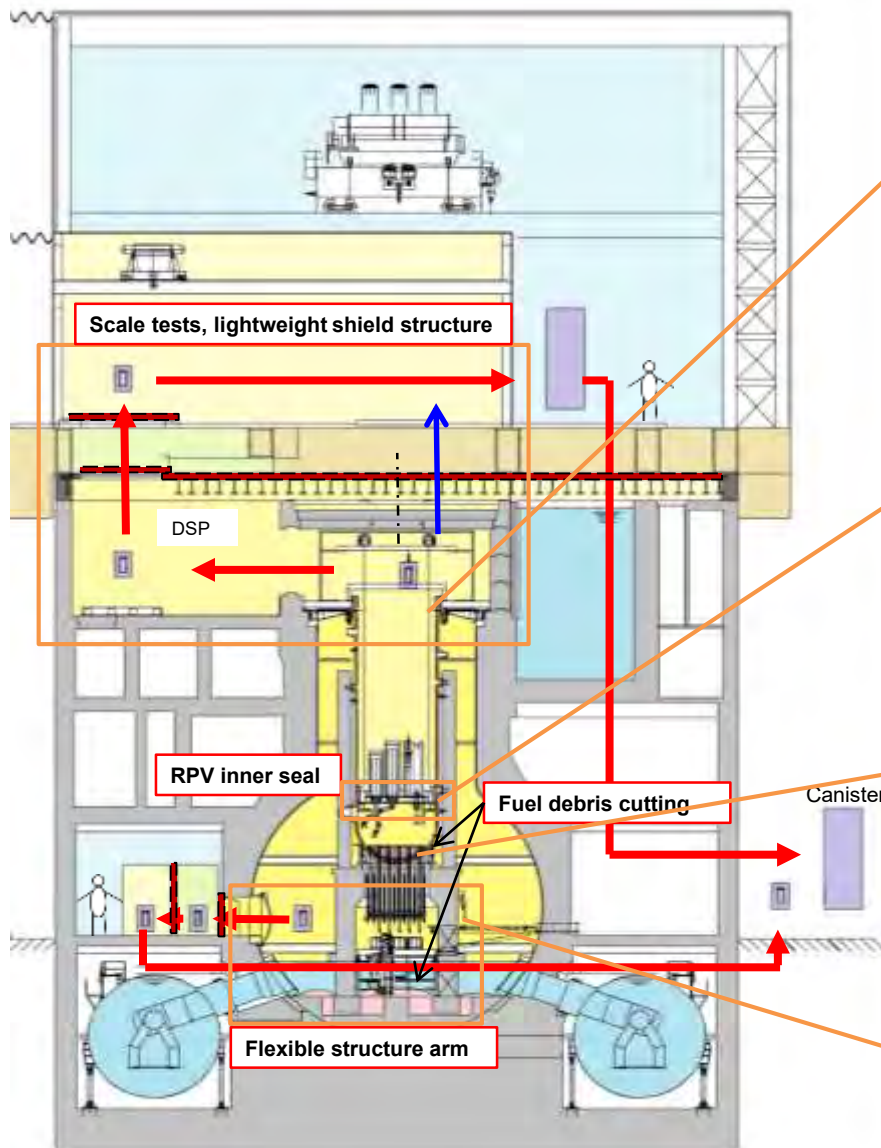

- Scale tests, development of lightweight shield structure

Former operation floor surface, Shield plug, Flexible structure arm, RPV head nozzles, Guide, DSP, Well, Equipment inside reactor well, RPV insulation material, Equipment inside reactor well, Shielding water pool (upper part), Shielding water pool (lower part), RPV head (1/4-scale model), Areas reinforced by Kevlar fibers

PCV head handrail dismantlement, Verification test on accessibility to the RPV insulation material for dismantlement, The shielding water pool installed over the RPV head

- Development of RPV inner seal technology

Full-scale mock-up of RPV internal structures, RPV inner seal, Pressure vessel, Lifting mechanism (hoisting attachment), Shroud support, Processor, Fuel debris, Arm of the processing tool (Property of Hitachi-GE Nuclear Energy, Ltd.), CRD housing, Installation of RPV internal structures

- Development of fuel debris cutting technology

Processing of common sample, Collected core, Canister, Aluminum oxide, Aluminum oxide, ø48 non-core bit, Impregnated bit

- Development of flexible structure arm (partial submersion-side access method)

Transportation of crane parts (column), Horizontal cutting, Connection of power connector

2. Achievements of Projects Implemented in FY2015 to FY2016

No.5

Application examples of developed basic and fundamental technology (3/3)

- Tests on PCV welding equipment for remote seal welding
Verification of basic feasibility of boundary construction between PCV and cell

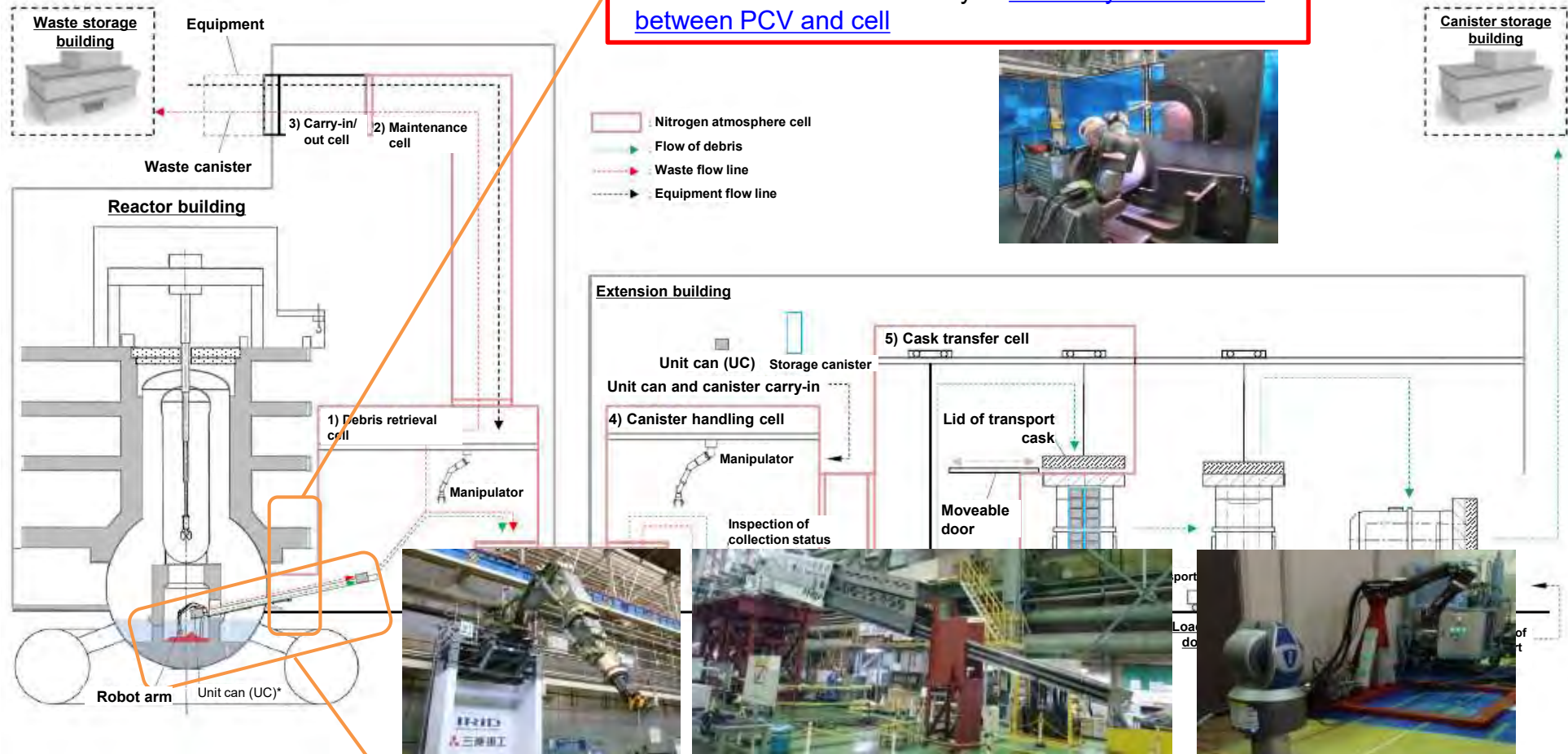

- Tests on access device inside the pedestal
Verification of basic feasibility of robot arm and access rail

- Tests on hydraulic manipulator
Acquisition of basic data for construction of control logic
Fundamental test for development of robot arm

*The unit can is abbreviated as UC.

3. Project Overview

3.1 Collaboration with other projects

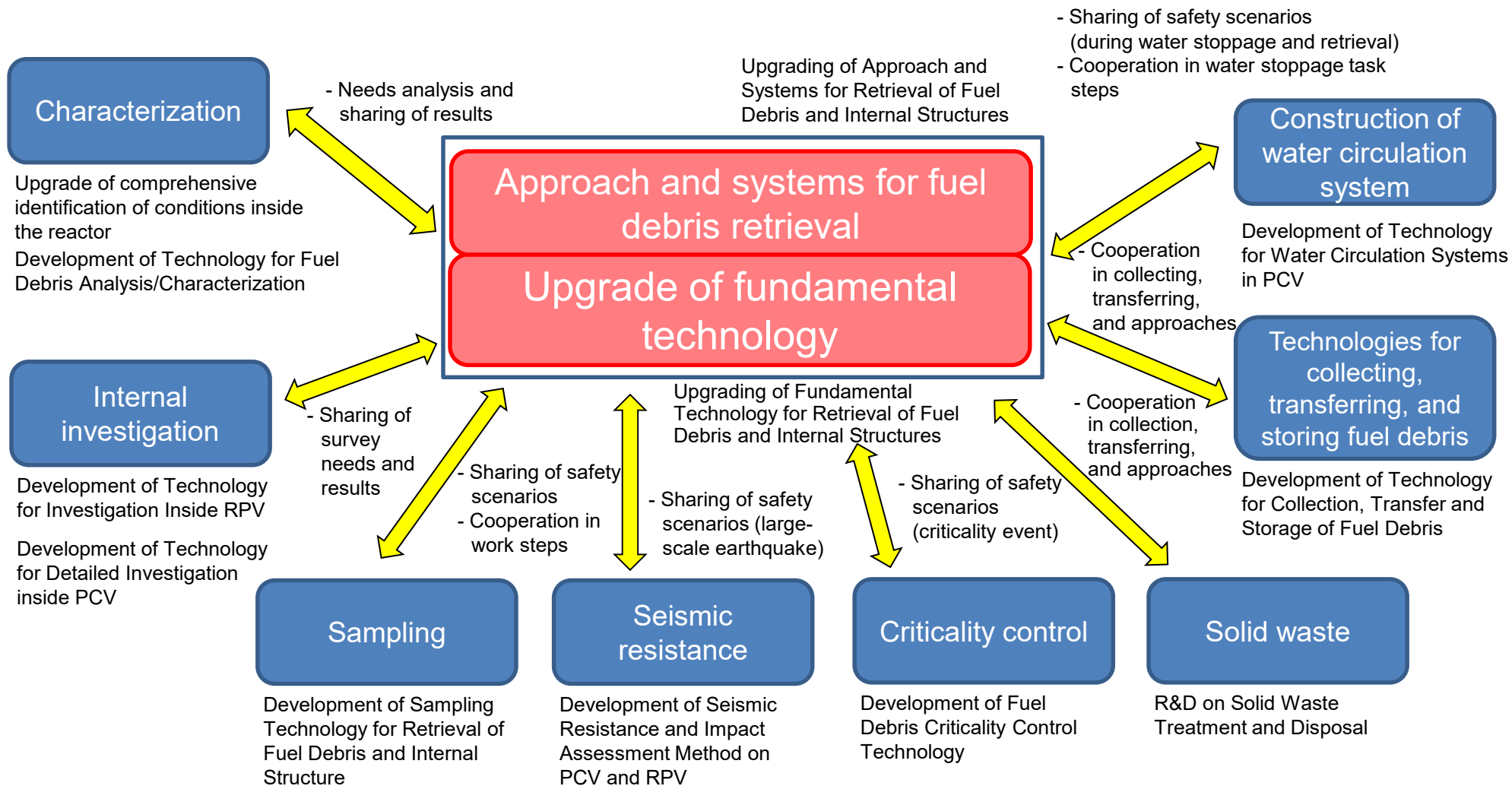

3. Project Overview

3.2. Basic policy on development of fundamental technology

Main action policies for matters arising in connection with implementing the project plan are as described below.

[Basic policy]

Policies for fundamental technology development shall be established based on the *Technical Strategic Plan 2017 for Decommissioning of the Fukushima Daiichi Nuclear Power Station of Tokyo Electric Power Company Holdings, Inc.* (hereinafter Strategic Plan 2017), which was formulated by the Nuclear Damage Compensation and Decommissioning Facilitation Corporation. Study and development themes shall be determined according to suggestions of the Strategic Plan 2017.

3. Project Overview

3.2. Basic policy on development of fundamental technology

[Suggestions in Strategic Plan 2017]

1. Develop a comprehensive fuel debris retrieval plan aimed to optimize the entire retrieval process, from preparation work and transfer from the site to treatment, storage, and cleanup, including coordination with other works in the field.
2. Move forward in a flexible manner according to the information gained little by little via a step-by-step approach after deciding the retrieval method to be focused on.
3. Assume that a combination of a variety of methods will be required to complete the fuel debris retrieval.
4. Promote preliminary engineering and R&D, focusing on the partial submersion method.
5. Firstly, focus on retrieving the fuel debris located at the bottom of the PCV and keep reviewing the methods based on know-how newly gained through the retrieval.
6. Focus on the route from the side of the PCV (the side access method) to first access the fuel debris located at the bottom of the PCV. The following are the points to be stressed in the construction that uses this method.
 - Reduction of radiation dose at work sites
 - Establishment of water level control technology
 - Establishment of cell connection technology and securing of area



- **Study and development will be conducted by focusing on technologies required to retrieve fuel debris at the PCV bottom by partial submersion-the side access method.**
- **Same as the above mentioned, common technologies that do not depend on methods such as collection technology, as well as cutting and dust collection technology, will be studied and developed, focusing on those that are highly applicable to the partial submersion-side access method. (e.g., collection of fuel debris in particle or powder form, processing of molten core concrete interaction [MCCI] fuel debris)**
- **With consideration to relevant information, including those obtained by investigating inside the PCV, various choices of methods will be prepared for different contingencies, in case a single technology or method is insufficient and flexible combinations of different technologies and methods are required.**

3. Project Overview

3.2. Basic policy on development of fundamental technology

Based on the policy listed in the previous sections, the implementation policies of each public development items are determined as follows.

Publicly offered development items	Implementation policy	Reference
1) Development of Technology for Prevention of Fuel Debris Spreading (1)Development of Fuel Debris Collection System	While retrieval technologies are applicable to different types of works in common, study and development shall focus on technologies necessary for retrieving fuel debris at the PCV bottom (including fuel debris fragments generated during the cutting process) using the side access method.	No.14 and later slides
(2)Development of Fuel Debris Cutting / Dust Collection System	While cutting and dust collection technologies are applicable to different types of works in common, study and development shall focus on technologies necessary for cutting and collecting fuel debris at the PCV bottom using the side access method.	No.67 and later slides
(3)Development of Prevention Method of Fuel Debris Spreading	The diffusion of fuel debris from the PCV bottom to vent pipes and the S/C may occur during fuel debris retrieval. Technologies for preventing the spread shall be studied and developed.	No.110 and later slides
2) Development of Element Technology for Retrieval Device Installation (1)Development of Element Technology for Work Cells	Technologies for connecting cells and PCV without leaking radioactive materials shall be studied especially closely and developed, including alternative methods for achieving the safe confinement of such materials. In addition, technologies for transporting and installing cells are concerned with issues related to worker exposure, and the impact assessment of cells on the reactor building is concerned with issues related to assurance of the safety function in an emergency. These technologies shall also be studied and developed.	No.128 and later slides
(2)Development of Technology for Interference Object Removal during Fuel Debris Retrieval	Methods and technologies for removing interfering objects that block access to fuel debris at the PCV bottom by the side access method shall be studied. Methods and technologies applicable to the dismantlement of interfering objects through top access shall be studied first. Then, further development shall be implemented on those that are found essential and difficult to be embodied.	No.186 and later slides
3) Development of Remote Maintenance Technology for Fuel Debris Retrieval Device	First, the basic approach of remote maintenance shall be established based on internal cell facilities for the side access method. Then, the study and development plan of maintenance equipment shall be formulated.	No.383 and later slides

4. Implementation Schedule and System of This Project

Schedule for Upgrading of Fundamental Technology for Retrieval of Fuel Debris and Internal Structures

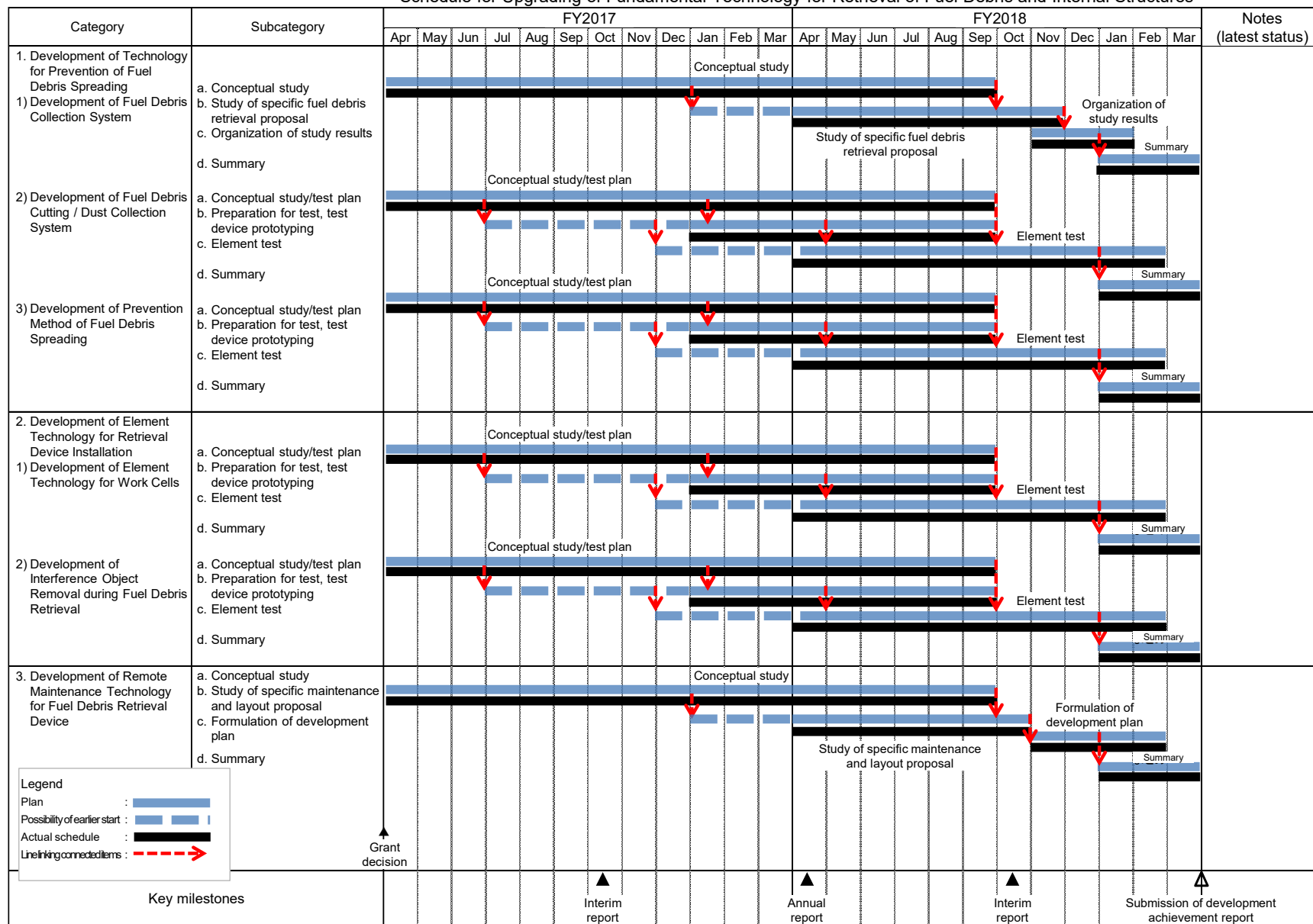

4. Implementation Schedule and System of This Project

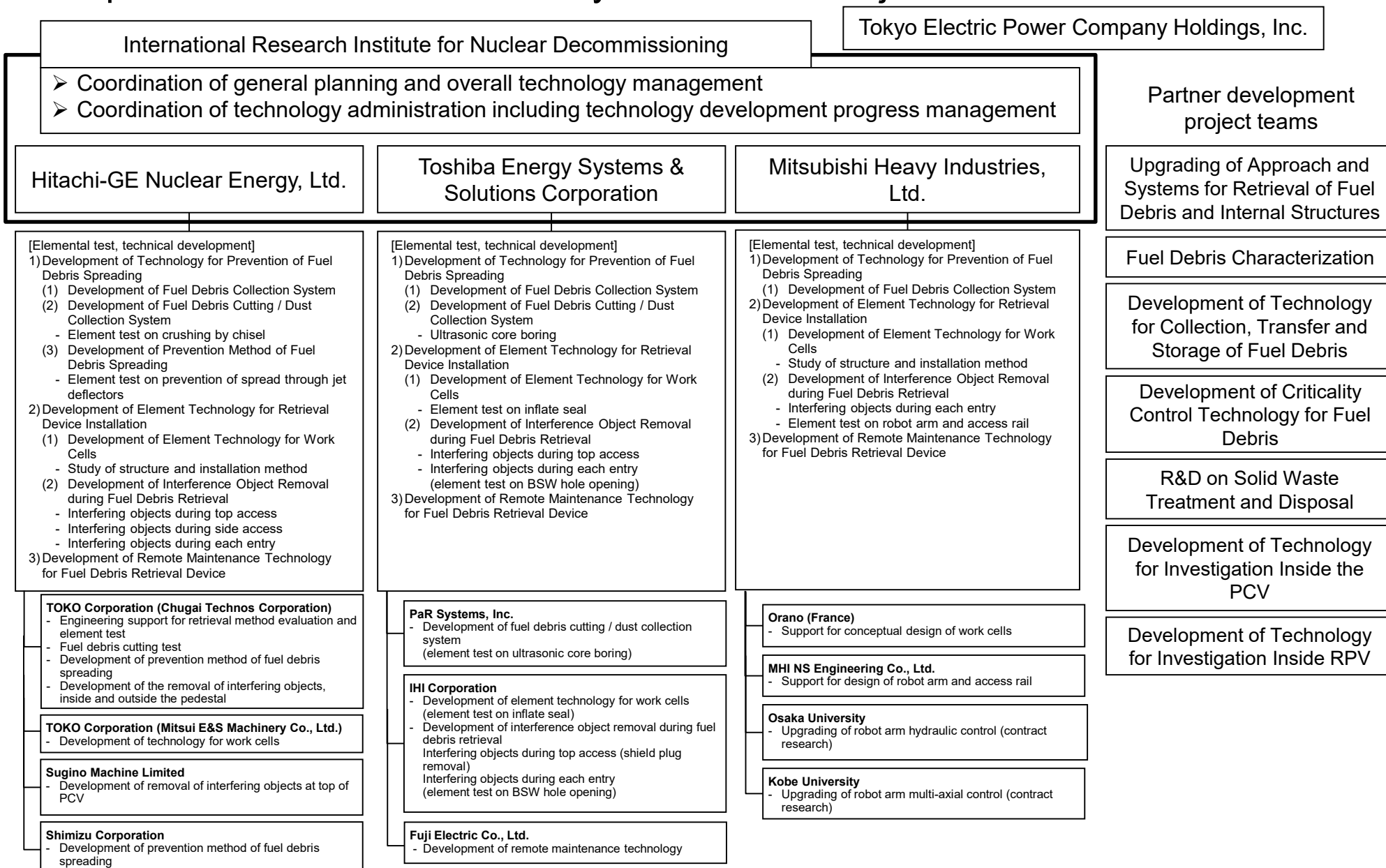

5. Details of Subsidized Projects

[Purpose]

From FY2017 to FY2018, design study and element tests were conducted based on the fuel debris retrieval policy announced in September 2017 and with consideration to the applicability to the policy. Preparations shall be made so that development of devices for the actual operation can be initiated for the retrieval of fuel debris from the initial unit.

[Main scope of the project]

1) Development of Technology for Prevention of Fuel Debris Spreading

Effective and flexible collection technologies applicable to different fuel debris conditions and technologies for collecting dust generated during the removal work will be developed, to prevent diffusion of dust and other materials produced during fuel debris retrieval.

2) Development of Element Technology for Retrieval Device Installation

During fuel debris retrieval operation, the site has high radiation and many of the tasks need to be conducted remotely. Remote operation technology necessary for the tasks, that will likely be conducted during the operation, will be developed.

3) Development of Remote Maintenance Technology for Fuel Debris Retrieval Device

Components and equipment used for fuel debris retrieval (e.g., fuel debris cutting and collecting system, shipping containers, work benches, monitoring equipment, and robot arms that handle fuel debris) are installed in a high-radiation area. For this reason, in principle, maintenance must be carried out remotely. This requires ideas on methods of maintenance regarding components and equipment suited for handling fuel debris to be reviewed and maintenance methods that are in line with such ideas to be studied. In addition, feasibility evaluation, identification of issues, and rational action policy for actual operation will be studied.

6. Implementation details of this project

6.1. Development plan

Below are the main items that are studied for implementation in this project. The details will be provided in the following pages.



Method for removing interfering objects by the fuel debris retrieval device designed for the side access method



Method for sealing work cell (inflate seal)

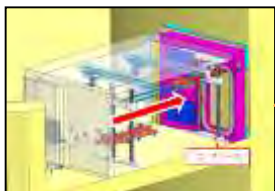

Opening of biological shielding wall (BSW)

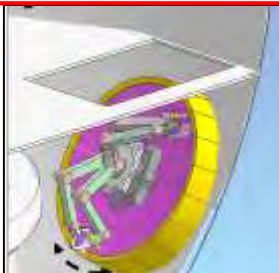

Preventive measures against the spread of contamination to the suppression chamber

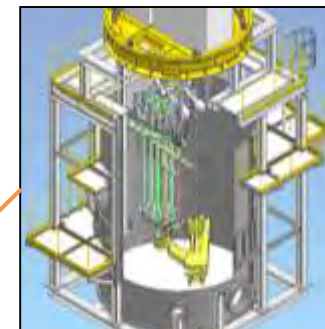
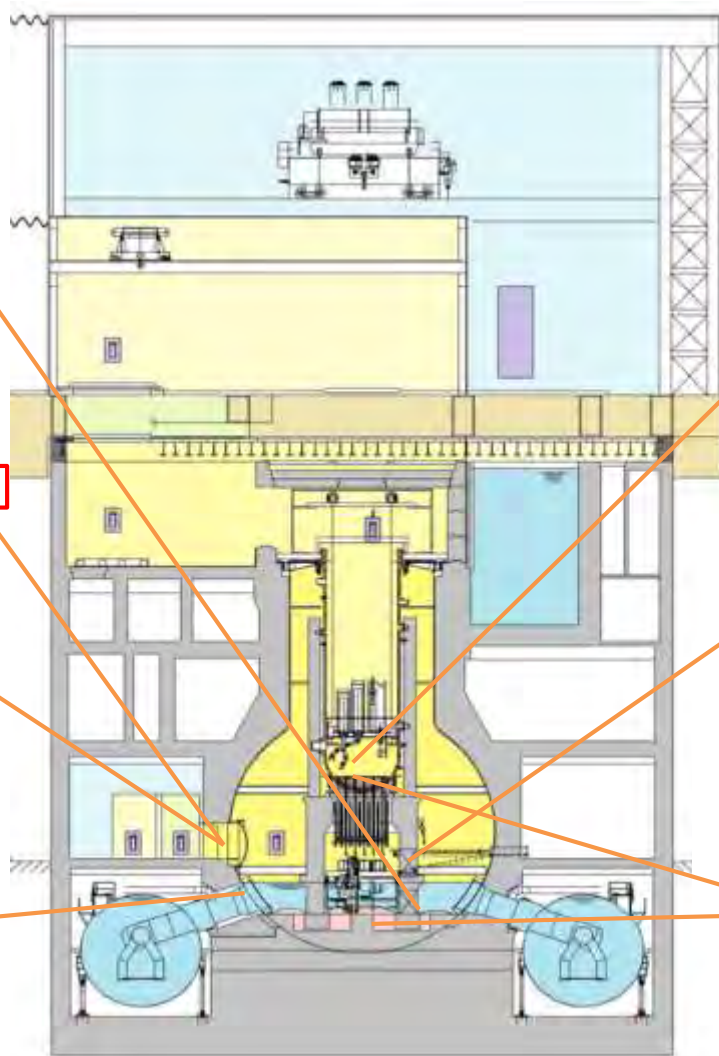

Development of technology for removing interfering objects and reactor bottom



Verification of the maneuverability of a combination of a robot arm and access rail



Processing method effective in terms of preventing diffusion of fuel debris

6. Implementation details of this project

6.2. Implementation details

1) Development of Technology for Prevention of Fuel Debris Spreading

(1) Development of Fuel Debris Collection System

(2) Development of Fuel Debris Cutting / Dust Collection System

(3) Development of Prevention Method of Fuel Debris Spreading

2) Development of Element Technology for Retrieval Device Installation

(1) Development of Element Technology for Work Cells

(2) Development of Interference Object Removal during Fuel Debris Retrieval

3) Development of Remote Maintenance Technology for Fuel Debris Retrieval Device

6. Implementation details of this project

6.2. Implementation details

1) Development of Technology for Prevention of Fuel Debris Spreading

(1) Development of Fuel Debris Collection System

Different collection methods and systems effective for various forms of the fuel debris (rubble, sludge, fine powder, etc.) that is believed to be present inside the PCV will be developed. Transportation and storage system used to deliver canisters containing collected fuel debris will be studied.

The following items on the fuel debris collection method and system will be studied. Element tests will be conducted as necessary to identify and address issues.

a. Methods and means of collecting fuel debris (suction, grabbing, etc.)

- Characteristics and distribution of fuel debris are reviewed.
- Based on the information obtained from the above-mentioned review, means of suction and grabbing are sorted out.

b. Method of storing fuel debris in unit cans

- Method of storing fuel debris in unit cans is made concrete based on the study results of the section a.

c. Method of adjusting water content of fuel debris (dehydration, drying, etc.)

- Regarding the method of adjusting water content of fuel debris, the relationship with the amount of hydrogen generated was partly verified.

d. Method of storing and transferring canisters containing unit cans

- Studies were conducted on unit cans of ϕ 200mm cans in principle.

6. Implementation details of this project

6.2. Implementation details

1) Development of Technology for Prevention of Fuel Debris Spreading

(1) Development of Fuel Debris Collection System

- Purpose of development
 - Develop effective collection methods and systems for various forms of fuel debris that is believed to exist inside the PCV.
- Issues to be solved
 - Concretization of specifications regarding fuel debris properties and amount (ratio of metal layer, fuel rods, fuel debris in powder, lump, grain, and crust form)
 - Concretization of method for collecting particle fuel debris by suction
- Approaches to development
 - Estimate of amount of fuel debris collected
 - ✓ Assumption of fuel debris properties, distribution, and processing method
 - ✓ Assumption of fuel debris properties and amount after processing
 - Concretization of collection processes such as grabbing and suction
 - ✓ Investigation on and benchmark of equipment for collection
 - ✓ Trade-off regarding the collection system
 - Study of interface conditions with the plant operation systems and infrastructure
 - Study of system for collecting and transferring unit cans to canisters
- Expected outcome
 - Feasibility of series of tasks up until fuel debris collection
 - Specification of particle fuel debris collection system
 - Fuel debris collection speed (throughput)

6. Implementation details of this project

6.2. Implementation details

1) Development of Technology for Prevention of Fuel Debris Spreading

(1) Development of Fuel Debris Collection System

a. Methods and means of collecting fuel debris (suction, grabbing, etc.)

i) Concretization of fuel debris properties and estimated amounts (Unit 1)

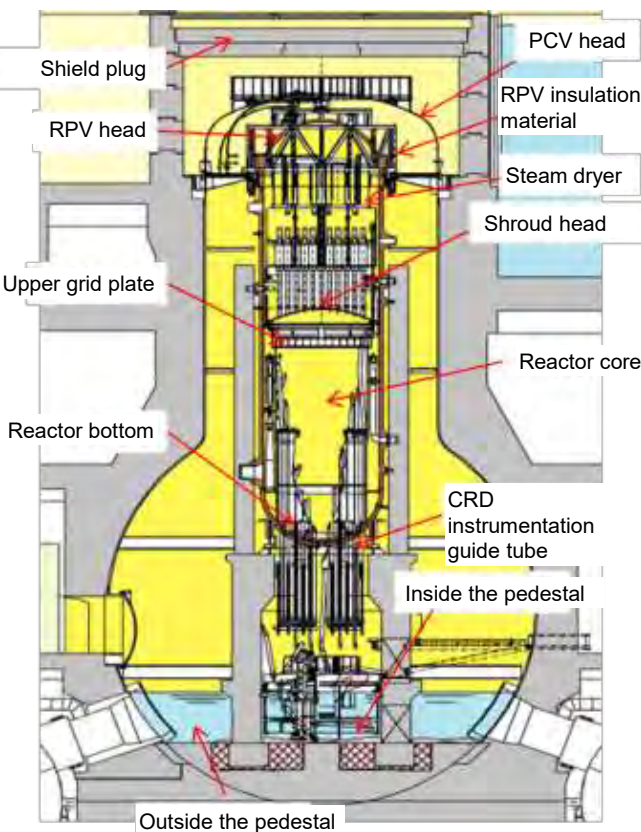

No.	Position of distribution	Characteristics	General state	Features	Mass [t]	Fuel debris properties	
					MAAP	Dimension	Configuration
1	Reactor core	Fuel rod stubs	All fuel assemblies may have melted down, but some may remain	Some fuel assemblies remain without melting down	0 to 3	up to 4 m	Fuel: UO ₂ Cladding: Zry-2
		Powdery/grained	Adhered to or stacked on residual structures	Molten core materials rapidly cooled down, turning into small pieces		Few μm to few cm	(U, Zr)O ₂ (Zr, U) O ₂
2	Reactor bottom	Powdery/grained	Most of the fuel debris in this area consists of crust	Molten core materials rapidly cooled down, turning into small pieces	7 to 20	Few μm to few cm	(U, Zr)O ₂ (Zr, U) O ₂
		Lumps	The crust contains Zr metals and ZrB; some parts are hard and tough	Slowly cooled down and formed lumps		Thickness Few dozen cm	(U, Zr)O ₂ (Zr, U) O ₂
		Crust (bedrock)		Molten metals and oxide fuel mixed and solidified into fuel debris		Thickness 0.1 to 1 m	(U, Zr) O ₂ , (Zr, U) O ₂ , Zr(O), Fe
3	CRD/instrumentation guide tube	Structure and adhered fuel debris	Fuel debris adhered in gaps inside and on the outer surface of tubes	Fuel debris clogged the flow passage in the lower SUS piping from the bottom end of the RPV		Penetration depth Ten-plus cm	(U, Zr) O ₂ , (Zr, U) O ₂ , SUS
4	Inside the pedestal	MCCI/powdery or grained	The fuel debris forms multiple layers; most are likely to consist of MCCI debris in lump form	Molten reactor core materials leaked out of the RPV, dispersed, quenched, and solidified; crust fractured during MCCI and broke into small pieces due to ejection of molten corium	120 to 209	50 μm or more 20 cm	(U, Zr) O ₂ , (U, Zr) SiO ₂
		MCCI crust	Large amounts of highly porous and brittle fuel debris is present	Ejected materials containing metal components adhered to the wall surface. Fuel debris on the floor has a hollow structure, and the upper part of the crust is porous and has less metal components.		Thickness: 0.1 to 1 m	(U, Zr) O ₂ , (U, Zr) SiO ₂ , SiO ₂
		MCCI debris in lump form		Upper part of the fuel debris consists of rigid corium and is highly porous Lower part is rigid with low porosity Metallic balls are in the central area and near the wall		A few dozen cm or more	(U, Zr) O ₂ , (U, Zr) SiO ₂ , SiO ₂
		Metal layer		Distributed relatively evenly at the bottom of MCCI debris		Under study	Fe, FeSiO ₂ , Fe-Zr
5	Outside the pedestal	MCCI/powdery or grained	Layer separation is not as clear as those inside the pedestal; there is a crust and lumps of MCCI debris	Grained debris has leaked from the pedestal	70 to 153	50 μm or more 20 cm	(U, Zr) O ₂ , (U, Zr) SiO ₂
		MCCI crust/lumps of MCCI debris		Corium leaked from the pedestal, reacted with concrete, and solidified; the debris had a slightly rich metal content		up to 0.5 m	(U, Zr) O ₂ , (U, Zr) SiO ₂ , SiO ₂ , FeSiO ₂

6. Implementation details of this project

6.2. Implementation details

1) Development of Technology for Prevention of Fuel Debris Spreading

(1) Development of Fuel Debris Collection System

a. Methods and means of collecting fuel debris (suction, grabbing, etc.)

i) Concretization of fuel debris properties and estimated amounts (Unit 2)

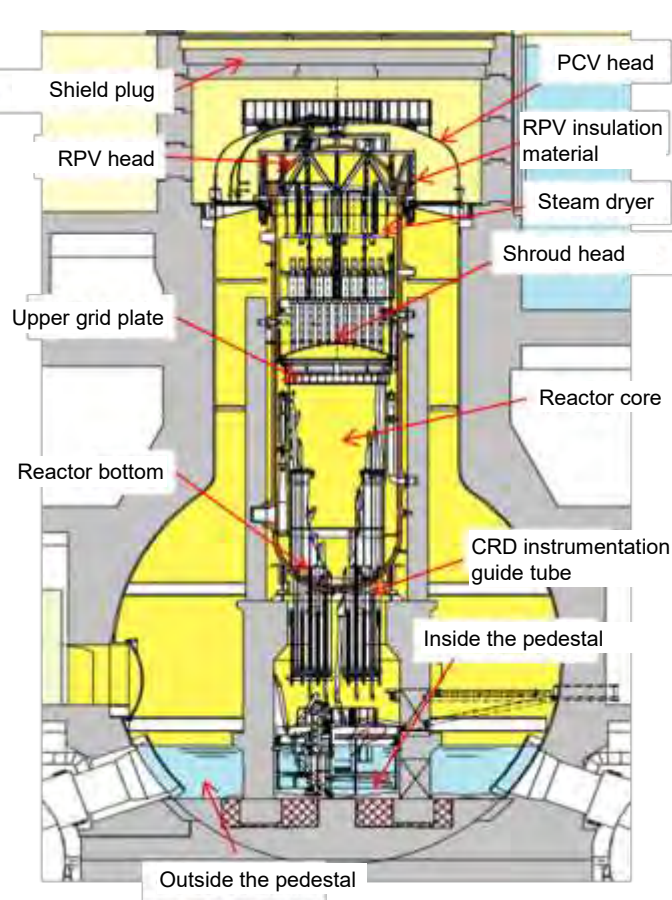

No.	Position of distribution	Characteristics	General state	Features	Mass [t]	Fuel debris properties	
					MAAP	Dimension	Configuration
1	Reactor core	Fuel rod stubs	Fuel assemblies remain in the reactor core periphery	The top part of the fuel assemblies in the reactor core periphery melted down; few fuel rod stubs remained. The molten material contains 25% metal components.	0 to 51	up to 4 m	UO ₂ , ZrO ₂ , (U, Zr)O ₂ , Zr(O)
		Powdery/grained	Adhered to or stacked on residual structures	Molten core materials rapidly cooled down, turning into small pieces		Few μm to few cm	(U, Zr)O ₂ , (Zr, U)O ₂
2	Reactor bottom	Powdery/grained	Debris is present in the center of the RPV bottom. Its main component is assumed to be UO ₂ (some debris are in pellet form). Some of the CRGT remained in the reactor core periphery without melting.	Molten core materials rapidly cooled down, turning into small pieces.	25 to 85	Few μm to few cm	(U, Zr)O ₂ , (Zr, U)O ₂
		Lumps		Slowly cooled down and formed lumps		Thickness: Few dozen cm	(U, Zr)O ₂ , (Zr, U)O ₂
		Crust (bedrock)		Molten metals and oxide fuel mixed and solidified into fuel debris		Thickness: 0.1 to 1 m	(U, Zr)O ₂ , (Zr, U)O ₂ , Zr(O), Fe
3	CRD/instrumentation guide tube	Piping	Fuel debris adhered in gaps inside and on the outer surface of tubes	Fuel debris clogged the flow passage in the lower SUS piping from the bottom end of the RPV		Penetration depth: Ten-plus cm	(U, Zr)O ₂ , (Zr, U)O ₂ , SUS
4	Inside the pedestal	Powdery/grained	Most of the molten fuel debris solidified without hardly forming MCCI debris because the timing of water injection was too early.	Molten reactor core materials leaked out of the RPV, quenched, solidified, and dispersed. Showed little reaction with concrete.	102 to 223	50 μm to 20 cm	UO ₂ , Zr(O), (U, Zr)O ₂ , Fe
		Lumps	There may be MCCI debris in the sump pit.	Lumps of solidified debris is distributed uniformly. There may be MCCI debris in the sump pit.		Thickness: 15 cm	UO ₂ , Zr(O), (U, Zr)O ₂ , Fe, (U, Zr)SiO ₂
5	Outside the pedestal	Powdery/grained	Solidified fuel debris leaked from the pedestal; most were powder and grained debris.	Grained debris has leaked from the pedestal.	3 to 142	50 μm or more, 20 cm	UO ₂ , Zr(O), (U, Zr)O ₂ , Fe
		Lumps		Corium leaked from the pedestal, reacted with concrete, and solidified; the debris had a slightly rich metal content.		Penetration depth: up to 0.25 m	UO ₂ , Zr(O), (U, Zr)O ₂ , Fe, (U, Zr)SiO ₂

6. Implementation details of this project

6.2. Implementation details

1) Development of Technology for Prevention of Fuel Debris Spreading

(1) Development of Fuel Debris Collection System

a. Methods and means of collecting fuel debris (suction, grabbing, etc.)

i) Concretization of fuel debris properties and estimated amounts (Unit 3)

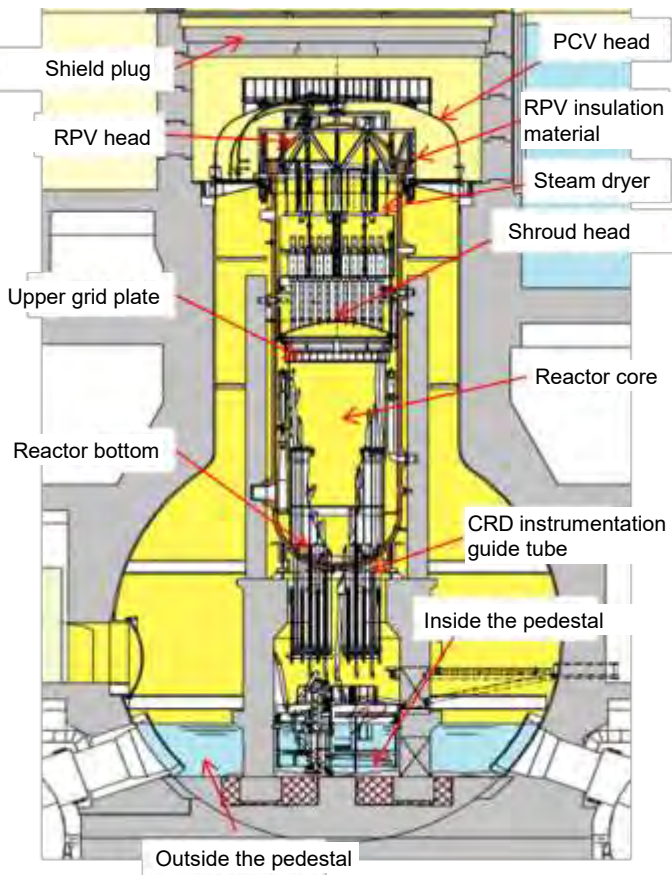

No.	Position of distribution	Characteristics	General state	Features	Mass [t]		Fuel debris properties	
					MAAP	Dimension	Configuration	
1	Reactor core	Fuel rod stubs	Almost all the fuel melted down, and some undamaged fuel assemblies remained in the reactor core periphery (MAAP)	The top part of the fuel assemblies in the reactor core periphery melted down; few fuel rod stubs remained	0 to 31	up to 4 m	UO ₂ , ZrO ₂ , (U, Zr) O ₂ , Zr (O)	
		Powdery/grained	Adhered to or stacked on residual structures	Molten core materials rapidly cooled down, turning into small pieces		Few μm to few cm	(U, Zr)O ₂ , (Zr, U) O ₂	
2	Reactor bottom	Powdery/grained	Both the MAAP and SAMPSON codes indicate small amounts of fuel debris in the lower plenum	Molten core materials rapidly cooled down, turning into small pieces	21 to 79	Few μm to few cm	(U, Zr)O ₂ , (Zr, U) O ₂	
		Lumps		Slowly cooled down and formed lumps		Thickness: Few dozen cm	(U, Zr)O ₂ , (Zr, U) O ₂	
		Crust (bedrock)	Molten metals and oxide fuel mixed and solidified into fuel debris	Thickness: 0.1 to 1 m		(U, Zr) O ₂ , (Zr, U) O ₂ , Zr(O), Fe		
3	CRD/instrumentation guide tube	Piping	Fuel debris adhered in gaps inside and on the outer surface of tubes	Fuel debris clogged the flow passage in the lower SUS piping from the top end of the RPV		Penetration depth: Ten-plus cm	(U, Zr) O ₂ , (Zr, U) O ₂ , SUS	
4	Inside the pedestal	Powdery/grained	Most of the molten fuel debris solidified without hardly forming MCCI debris because the timing of water injection was too early	Molten reactor core materials leaked out of the RPV, quenched, solidified, and dispersed. Showed little reaction with concrete	92 to 277	Few μm to few cm	UO ₂ , Zr(O), (U, Zr) O ₂ , Fe	
		Lumps	There may be MCCI debris in the sump pit	Lumps of solidified debris is distributed uniformly. There may be MCCI debris in the sump pit		Thickness: 15 cm	UO ₂ , Zr(O), (U, Zr) O ₂ , Fe, (U, Zr) SiO ₂	
5	Outside the pedestal	Powdery/grained	Solidified fuel debris leaked from the pedestal; most were powder and grained debris	Grained debris has leaked from the pedestal	0 to 146	50 μm or more to 20 cm	UO ₂ , Zr(O), (U, Zr) O ₂ , Fe	
		Lumps		Corium leaked from the pedestal, reacted with concrete, and solidified; the debris had a slightly rich metal content		Penetration depth: up to 0.20 m	UO ₂ , Zr(O), (U, Zr) O ₂ , Fe, (U, Zr) SiO ₂	

6. Implementation details of this project

6.2. Implementation details

1) Development of Technology for Prevention of Fuel Debris Spreading

(1) Development of Fuel Debris Collection System

a. Methods and means of collecting fuel debris (suction, grabbing, etc.)

- Classification of fuel debris by size and method of collecting

There are fuel debris of various sizes in the PCV. A fuel debris in lump form needs to be processed before collecting it in a unit can ($\phi 200$ mm \times H 200 mm), where as particle or powder debris can be stored as is.

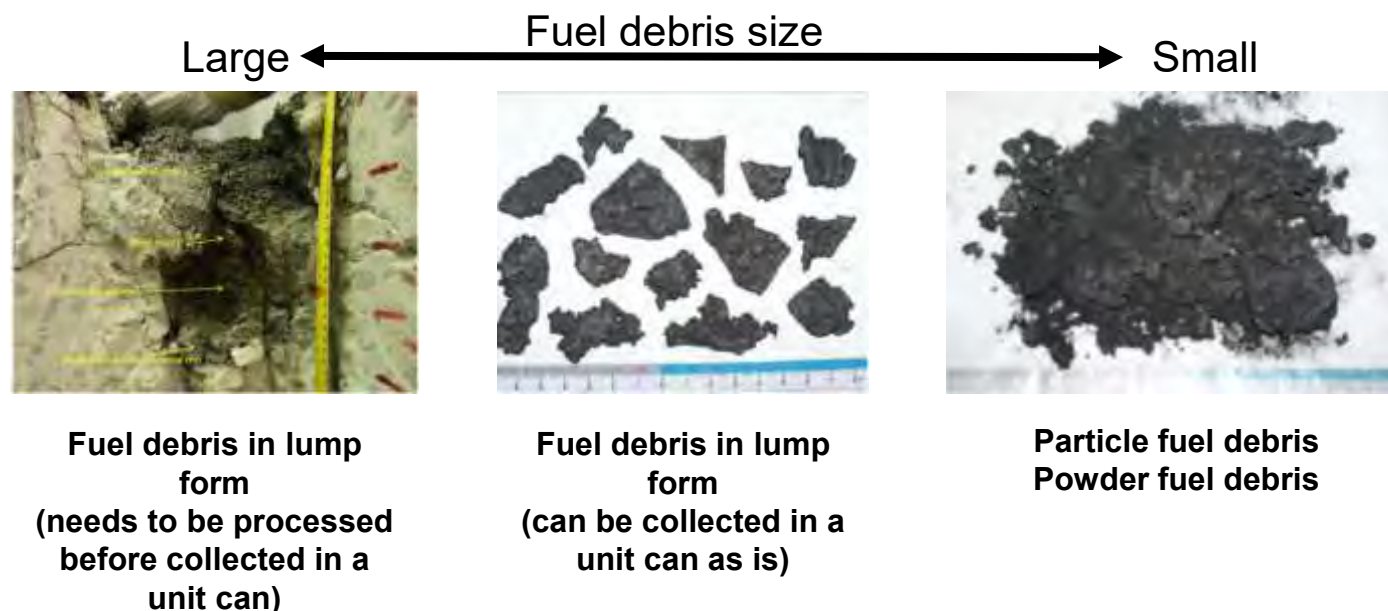

6. Implementation details of this project

6.2. Implementation details

1) Development of Technology for Prevention of Fuel Debris Spreading

(1) Development of Fuel Debris Collection System

a. Methods and means of collecting fuel debris (suction, grabbing, etc.)

- Classification of fuel debris by size and collecting methods

Classification	Fuel debris size	Collecting methods	Notes
Powder	Smaller than 0.1 mm	Sucked by the liquid phase system.	*1
Particle	0.1 mm to 10 mm	Sucked by pump.	*2
Lumps	10 mm to 100 mm (a size that can be collected in a unit can as is)	Grabbed by bucket-like tool or tong-like tool.	*3
	Larger than 100 mm (a size that needs to be processed before collected in a unit can)	Processed into a size that would fit in a unit can and collected by methods *1 to *3 depending on its size after processing.	*4

*1: Fuel debris smaller than 0.1 mm is collected by suction using a the liquid phase circulation system as the debris will likely float and not settle at the bottom.

*2: Particle fuel debris which is relatively small is collected by suction using a pump as this method is likely to be faster than collecting by scooping or grabbing.

*3: There are two types of fuel debris in lump form that can't be sucked by a pump: one that requires processing and another that does not. Those that do not require processing is generally collected using a bucket-like tool. Those near structures that cannot be grabbed by the tool are collected by picking it with a tong-like tool.

*4: A larger fuel debris that needs to be processed before it is collected in a unit can is processed into a size that can fit inside a unit can and collected by methods *1 to *3 depending on its size after processing.

6. Implementation details of this project

6.2. Implementation details

1) Development of Technology for Prevention of Fuel Debris Spreading

(1) Development of Fuel Debris Collection System

a. Methods and means of collecting fuel debris (suction, grabbing, etc.)

- Study of fuel debris suction collection method

i) Clarification of preconditions for achieving fuel debris suction collection method

During pre-staging before starting the study of concretization of particle fuel debris suction collection system, the preconditions were specified as follows.

- | | |
|---|-----------------------------|
| a) Size of particle fuel debris | $\phi 0.1$ to $\phi 10$ mm |
| b) Specific gravity of fuel debris | 2 to 11 |
| c) Fuel debris suction velocity | 2 m/sec (see diagram below) |
| d) Particle fuel debris collection velocity | Under study |

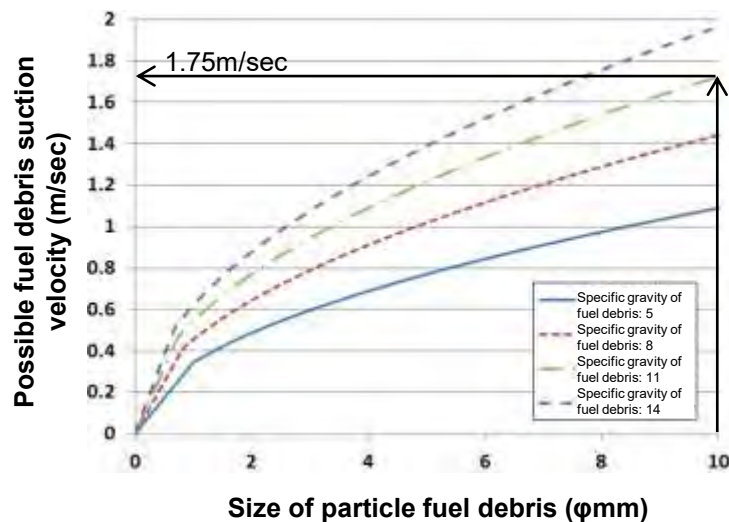

- If the flow velocity exceeds the terminal settling velocity when the water is still, the particles can be sucked.
- The terminal settling velocity when the water is still was calculated based on the expected size and specific gravity of particle fuel debris and was specified as the flow velocity at which fuel debris can be sucked.
- Based on the calculation results, the maximum (size: $\phi 10$ mm, specific gravity: 11) flow velocity was 1.75 m/sec. A margin was provided and **the suction flow velocity is specified as 2 m/sec.**

6. Implementation details of this project

6.2. Implementation details

1) Development of Technology for Prevention of Fuel Debris Spreading

(1) Development of Fuel Debris Collection System

a. Methods and means of collecting fuel debris (suction, grabbing, etc.)

- Study of fuel debris suction collection method

ii) Study of suction methods

There are two types of methods for collecting particle fuel debris by suction: Suction from the bottom surface* and underwater suction.

The main issues of these methods are examined in this section.

	Suction from bottom surface*	Underwater suction
Conceptual image	<p>(suction hose is attached to the end of the robot arm)</p> <p>Solid-liquid separation equipment</p> <p>Suction equipment</p> <p>PCV</p> <p>Fuel debris</p>	<p>Solid-liquid separation equipment</p> <p>Suction equipment</p> <p>Robot arm (system is attached to the end of the robot arm)</p> <p>PCV</p> <p>Fuel debris</p>
Main issues	<ul style="list-style-type: none"> • Confirmation of details on necessary ancillary equipment • Availability of floor space for installation • Verification of impact of hose pressure drop at fuel debris suction flow velocity 	<ul style="list-style-type: none"> • Maintainability of the suction collection system • Weight and size of the system that conform to the restrictions of the robot arm's payload capacity • Method of packaging collected fuel debris in a canister

*"Bottom surface" means the 1st floor of the reactor building.

6. Implementation details of this project

6.2. Implementation details

1) Development of Technology for Prevention of Fuel Debris Spreading

(1) Development of Fuel Debris Collection System

a. Methods and means of collecting fuel debris (suction, grabbing, etc.)

- Study of fuel debris suction collection method

ii) Study of the suction method

a) Study of suction from the bottom surface

The main issues identified in the previous page are studied by the following method.

<Availability of space for installation>

- Identify ancillary equipment that are likely required (e.g., shielding wall, maintenance equipment).
- Examine the general layout of those equipment to prepare for the installation on the surface of the first floor of the reactor building.

<Study of possibility of suction at fuel debris suction flow velocity>

- When the saturated vapor pressure of the fluid falls during suction by pump, air bubbles form and the pump may idle (can't suck fluid). Conduct a desk study to see whether suction at fuel debris suction flow velocity (2 m/s) is possible using the provisional layout.

Based on the study above, the feasibility of the collection system of particle fuel debris by suction from the bottom surface is evaluated.

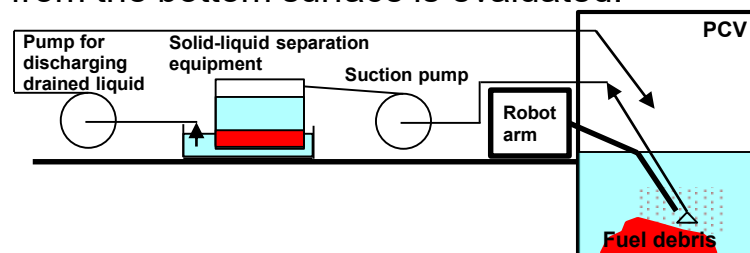

- Suction hose is attached to the robot arm
- Liquid drained from the solid-liquid separation equipment is returned to the PCV

Conceptual image of the system for suction from the bottom surface

6. Implementation details of this project

No.25

6.2. Implementation details

1) Development of Technology for Prevention of Fuel Debris Spreading

(1) Development of Fuel Debris Collection System

a. Methods and means of collecting fuel debris (suction, grabbing, etc.)

- Study of fuel debris suction collection method

a) Study of suction from the bottom surface

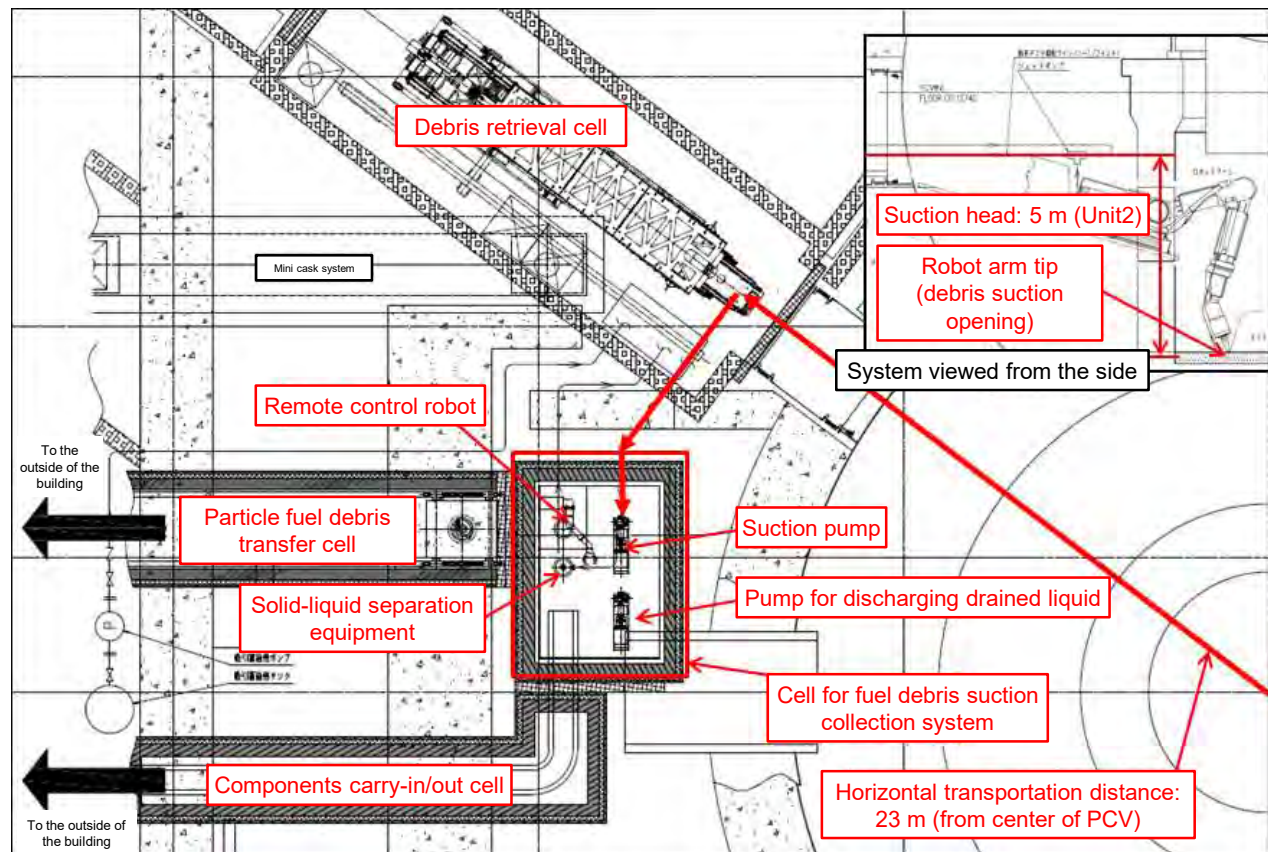

Suction from the bottom surface: overview of the fuel debris suction collection system studied for installation

6. Implementation details of this project

6.2. Implementation details

1) Development of Technology for Prevention of Fuel Debris Spreading

(1) Development of Fuel Debris Collection System

a. Methods and means of collecting fuel debris (suction, grabbing, etc.)

- Study of fuel debris suction collection method

a) Study of suction from the bottom surface

Desk study was conducted on whether air bubbles would form in the fluid under the following suction conditions (whether suction is possible with the specified flow velocity).

Conditions		Notes
Velocity of flow	2m/s	Terminal settling velocity of $\phi 10$ mm fuel debris with a specific gravity of 11 calculated by tabletop calculation
Horizontal distance of piping	23m	Horizontal distance from the center of the PCV to the pump
Water temperature	35°C	Temperature inside the PCV of Unit 2 in which the temperature is higher on the maintenance side

<Unit1>

Diameter of suction hose	1 1/2 inch	2 inches	3 inches
PCV water level/suction head (m)	2.8 m/3 m		
Air bubbles	Produced	Produced	Not produced (suction is possible)

<Unit2>

Diameter of suction hose	1 1/2 inch	2 inches	3 inches
PCV water level/suction head (m)	0.3 m/5 m		
Air bubbles	Produced	Produced	Produced

<Unit3>

Diameter of suction hose	1 1/2 inch	2 inches	3 inches
PCV water level/suction head (m)	6.5 m/1 m		
Air bubbles	Not produced (suction is possible)	Not produced (suction is possible)	Not produced (suction is possible)

[Results]

- Air bubbles don't form in Unit 3 only and it is expected that particle fuel debris can be collected by suction.
- Air bubbles formed in the fluid in Units 1 and 2 and particle fuel debris cannot be collected by suction at the designated flow speed.

6.2. Implementation details

1) Development of Technology for Prevention of Fuel Debris Spreading

(1) Development of Fuel Debris Collection System

a. Methods and means of collecting fuel debris (suction, grabbing, etc.)

- Study of fuel debris suction collection method

a) Study of suction from the bottom surface

<Verification result of availability of space for installation>

- If the equipment is installed outside the reactor building, the piping from inside the PCV to the equipment will be too long. Layout of ancillary equipment is examined by installing it near the X-6 penetration on the 1st floor of the reactor building.
- A layout in which the ancillary equipment is installed separately from the fuel debris retrieval cell is examined to avoid interference with the carry-in/out task of the access device.
- Equipment for transferring unit cans containing collected particle fuel debris outside is required.
- In step with the maintenance of components of the suction collection system, equipment for transferring components and equipment in and out the building is required.
- A remotely controlled device is required for maintenance of components of the suction collection system.
- As a relatively large space is needed, it is difficult to secure installation space on the 1st floor of the reactor building.

<Verification results of impact of hose pressure drop at fuel debris suction flow velocity>

- Cavitation did not occur in Unit 3 only and it is expected that particle fuel debris can be collected by suction.
- Cavitation occurred in Units 1 and 2 and particle fuel debris cannot be collected by suction.

[Conclusion]

- Direct suction on bottom surface cannot be adopted as a system common among Units 1 to 3.
- A lot of ancillary equipment needs to be installed in the tight space on the 1st floor of the reactor building.

Therefore, it was concluded that this method has **too great of a disadvantage** to be considered as the main idea for the collection of particle fuel debris by suction.

6. Implementation details of this project

No.28

6.2. Implementation details

1) Development of Technology for Prevention of Fuel Debris Spreading

(1) Development of Fuel Debris Collection System

a. Methods and means of collecting fuel debris (suction, grabbing, etc.)

- Study of fuel debris suction collection method

b) Study of underwater suction method

Ideas of measures against the main issues identified in section ii) are shown below.

A conceptual image of the system for underwater suction method is also shown below.

Main issues	Ideas of measures
Maintainability of the suction collection system	Components such as pumps need to be replaced regularly due to problems of radiation resistance. These will be retrieved, replaced, and maintained together with the robot arm.
Size and weight of the system	Assuming that a system for collecting particle fuel debris by suction will be attached to the robot arm, the size and weight of the system will be designed to be within the allowable limit of the robot arm.
Method for storing collected fuel debris in a canister	When withdrawing the robot arm, a remote control robot intended for maintenance of the robot arm will retrieve a unit can containing collected fuel debris and store it in a canister.

Commercial pumps that can operate under water were used as a benchmark, and the feasibility of the particle fuel debris suction collection system that adopts underwater suction method was evaluated by creating a plan for the arrangement of the robot arm in the system and identifying issues.

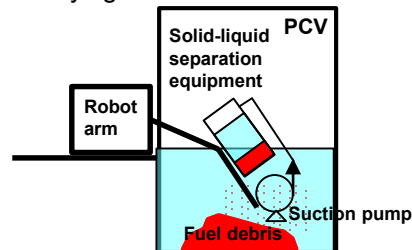

-Suction pump and solid-liquid separation equipment are attached to the robot arm

Conceptual image of the system for underwater suction method

6. Implementation details of this project

6.2. Implementation details

1) Development of Technology for Prevention of Fuel Debris Spreading

(1) Development of Fuel Debris Collection System

a. Methods and means of collecting fuel debris (suction, grabbing, etc.)

- Study of fuel debris suction collection method

b) Study of underwater suction method

- Benchmark results of commercial pumps that can be used under water (1/2)

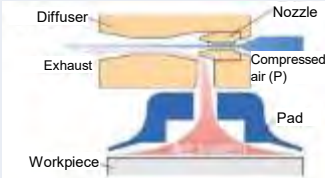
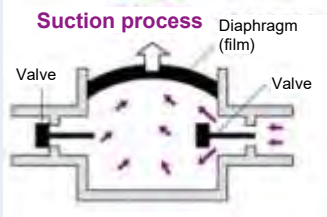
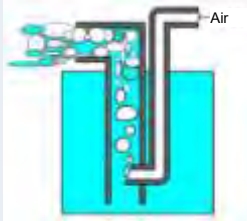
Type	Ejector pump	Diaphragm pump	Airlift pump
Principles and features	This type of pump is categorized as a special pump. It has three ports: a driving fluid inlet port, a transportation fluid inlet port, and a discharge port. The driving fluid injected from its inlet port causes negative pressure, aspirating the transportation fluid through its inlet port. Both the injected driving fluid and the aspirated transportation fluid are forced out from the discharge port together. In such a way, the transportation fluid is conveyed. This kind of pump has a low failure rate because it has no active component, but its energy efficiency is lower than other mechanical pumps.	This is one of the positive displacement pumps. This type of pump conveys fluid by changing the volume of the diaphragm and exerting pressure on the fluid.	This type of pump is categorized as a special pump. Compressed air is sent near the end of a tube placed vertically in water, creating a difference in specific gravity inside and outside the tube. Air bubbles are created and rise along the tube; the rising bubbles draw the fluid from the opening at the lower end of the tube. This kind of pump has a low failure rate because it has no active component, but is a low-head pump because the rising bubbles are the only driving force.
Schematic drawing			
Main application	This type of pump is often used for applications where a vacuum is required, such as deairing, defoaming, and distilling.	Applicability is proven in the Three Mile Island Nuclear Generating Station (TMI). This type of pump has a self-suction capability and doesn't cause problems in case of idling. It can convey fluids of high viscosity. It is often used for industrial, chemical, and sanitary applications.	Applicability is proven in the Three Mile Island Nuclear Generating Station (TMI). This type of pump is often used to convey removed soil at dredging work sites, to pump hot spring water, etc.
Applicability and remarks	<p>✘</p> <ul style="list-style-type: none"> - It has secondary issues such as selection of driving fluid, treatment, and impact on the environment. - It will also need a pump for the driving fluid. 	<p>✘</p> <ul style="list-style-type: none"> - It is not applicable because the diaphragm is made of organic materials and is not resistant to the environment 	<p>✘</p> <ul style="list-style-type: none"> - The fluid driving force is small since the water depth in the concerned unit is not as deep as that at TMI. - The space in 1F is narrow and it is difficult to maneuver robot arms.

6. Implementation details of this project

No.30

6.2. Implementation details

1) Development of Technology for Prevention of Fuel Debris Spreading

(1) Development of Fuel Debris Collection System

a. Methods and means of collecting fuel debris (suction, grabbing, etc.)

- Study of fuel debris suction collection method

b) Study of underwater suction method

-Benchmark results of commercial pumps that can be used under water (2/2)

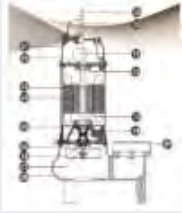
Type	Hydro-turbo pump	Submersible pump
Principles and features	This is a type of nonpositive displacement pump (turbo pump). It is driven by hydraulic pressure and is designed for use in special conditions where certain restrictions exist, such as no electric power. It is used by submerging it in the pumping fluid.	This is a type of nonpositive displacement pump (turbo pump). A submersible pump is a generic term for pumps used under water that is equipped with waterproof motors. It is mostly a centrifugal pump. Some are used for pumping waste water (agricultural wastewater and rainwater) and pumping out water at construction sites; they can transfer irregular solid objects such as gravel in the fluid.
Schematic drawing		
Main application	This type of pump is used in food processing machines and explosion-proof environments.	This type of pump is used under water in water treatment facilities, construction sites, commercial facilities, and households. The advantages of this pump are that because it can operate under water, it requires no installation space and it has low noise.
Applicability and remarks	△ Transports irregular solid objects of up to $\phi 6$ mm.	○ Transports irregular solid objects of $\phi 10$ mm or larger.

[Results]

Since this method can likely be applied to both the hydro-turbo pump and submersible pump, a conceptual study of both will be performed.

6. Implementation details of this project

No.31

6.2. Implementation details

1) Development of Technology for Prevention of Fuel Debris Spreading

(1) Development of Fuel Debris Collection System

a. Methods and means of collecting fuel debris (suction, grabbing, etc.)

- Study of fuel debris suction collection method

b) Study of underwater suction method

(a) Rough study conducted on feasibility of hydro-turbo pump

- The weight of the pump is expected to satisfy the weight limit of the robot arm (total weight: approx. 150 kg).
- The radiation resistance of the pump will be studied in the future.
- The hydro-turbo pump's driving pump and driving water tank installed on the floor may get contaminated if used incorrectly. Maintenance methods after contamination and shielding walls need to be studied.
- Commercial hydro-turbo pumps can only transport irregular solid objects of 6 mm or smaller. Since it doesn't meet the target ($\phi 10$ mm), a new design is required.

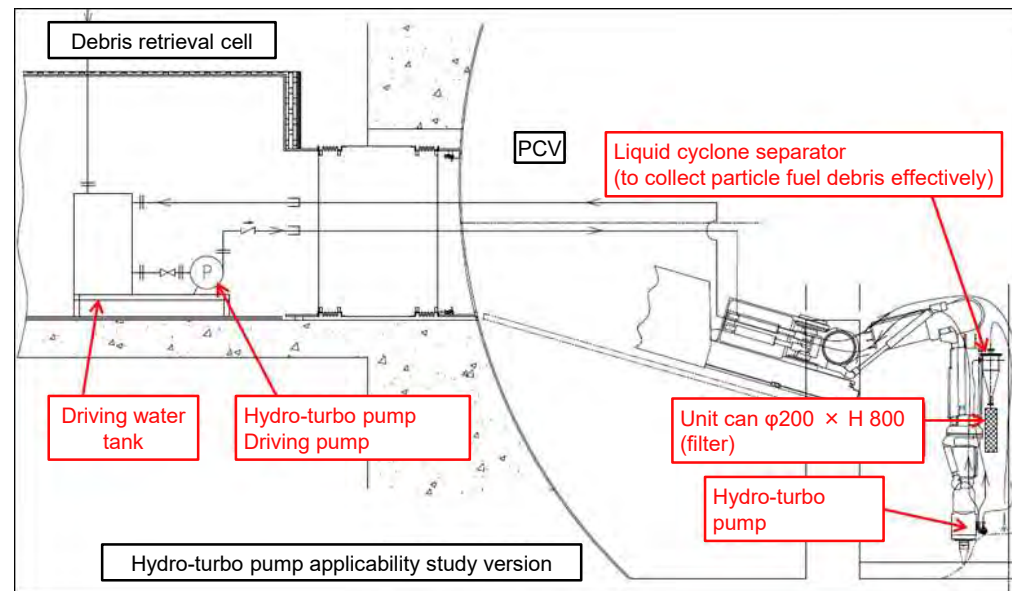

6. Implementation details of this project

No.32

6.2. Implementation details

1) Development of Technology for Prevention of Fuel Debris Spreading

(1) Development of Fuel Debris Collection System

a. Methods and means of collecting fuel debris (suction, grabbing, etc.)

- Study of fuel debris suction collection method

b) Study of underwater suction method

(b) Rough study conducted on feasibility of submersible pump

- The weight of the pump is expected to satisfy the weight limit of the robot arm (total weight: approx. 170 kg).
- The radiation resistance of the pump will be studied in the future.
- There is a lineup of commercial submersible pumps that can transport irregular solid objects of target size ($\phi 10$ mm) and larger.

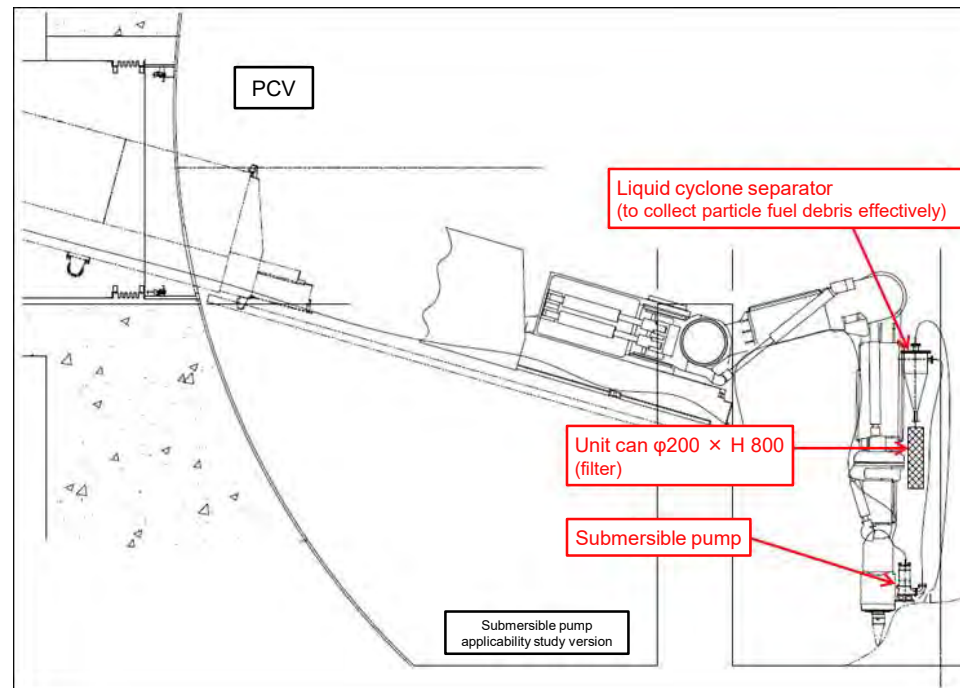

6. Implementation details of this project

No.33

6.2. Implementation details

1) Development of Technology for Prevention of Fuel Debris Spreading

(1) Development of Fuel Debris Collection System

a. Methods and means of collecting fuel debris (suction, grabbing, etc.)

- Study of fuel debris suction collection method

c) Results of conceptual study of feasibility

	Suction from the bottom surface	Underwater suction	
		Hydro-turbo pump	Submersible pump
Ancillary equipment	× Large ancillary equipment	△ Requires shielding walls for driving water pumps installed on floor	○ Doesn't require installation of new equipment on floor
Fuel debris Suction flow velocity	× Feasible only in Unit3	○ Feasible	○ Feasible
Equipment maintenance	× Requires separate maintenance equipment	○ Removed and provided maintenance together with the robot arm	
Robot arm installation	—	△ Requires study of downsizing	
Transportation of irregular solid objects (φ10 mm or larger)	○ Commercial product available	△ Commercial products support up to φ6 mm; requires new design	○ Commercial product available
Summary	× System cannot be common among units; Requires a lot of ancillary equipment	△ Common system can be used among different units; requires ancillary equipment on floor	○ Common system can be used among different units; doesn't require ancillary equipment on floor

[Conclusion] The main idea of the study is the submersible pump in which fuel debris is sucked with water.

6. Implementation details of this project

No.34

6.2. Implementation details

1) Development of Technology for Prevention of Fuel Debris Spreading

(1) Development of Fuel Debris Collection System

a. Methods and means of collecting fuel debris (suction, grabbing, etc.)

- Study of fuel debris suction collection method

iii) Issues to be examined concerning the feasibility study of underwater suction method

- The diagram below shows the idea of a system configuration produced based on the feasibility study results of underwater suction method.

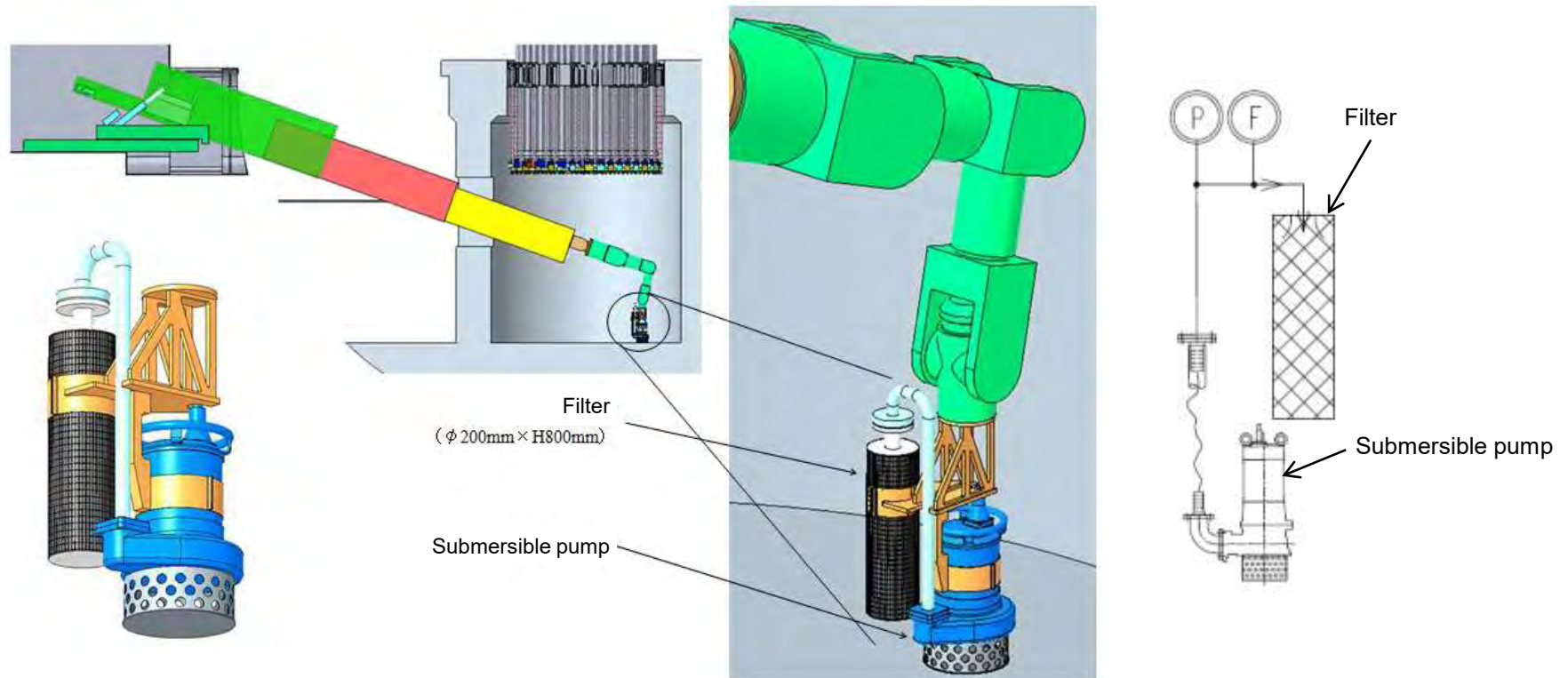

6. Implementation details of this project

No.35

6.2. Implementation details

1) Development of Technology for Prevention of Fuel Debris Spreading

(1) Development of Fuel Debris Collection System

a. Methods and means of collecting fuel debris (suction, grabbing, etc.)

- Study of fuel debris suction collection method

iii) Issues to be examined concerning the feasibility study of underwater suction method

- **Submersible pumps will be mainly studied** in the future; however, study will be conducted on a wide range of pumps and not limited to submersible pumps so as **not to exclude any possibility of other types of pumps suitable for application.**

<Piping>

- Study of internal diameter of piping (prevent clogging)
- Study of method for dealing with clogs

<Filter>

- Study of replacement method by remote control
- Study of filter mesh size
- Study of method for detecting clogged filters and fullness
- Study of resolving clogged filters

<Overall>

- Study of radiation resistance (including sensors)
- Study of throughput
- Cooperation with Robot Arm and Storage Canister Project

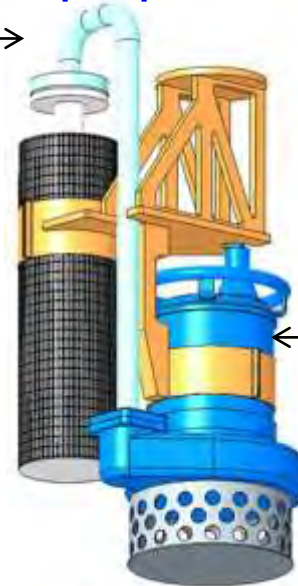

<Pump>

- Selection of pump type
- Study of backwash mechanism (e.g., axial-flow pump) as a method for resolving strainer blockage
- Study of amount of wear on internal parts
- Study of replacement method by remote control

<Pump strainer>

- Study of optimal shape for fuel debris suction
- Study of methods for detecting, preventing, and resolving clogged strainers
- Study of replacement method by remote control

6. Implementation details of this project

No.36

6.2. Implementation details

1) Development of Technology for Prevention of Fuel Debris Spreading

(1) Development of Fuel Debris Collection System

a. Methods and means of collecting fuel debris (suction, grabbing, etc.)

- Study of fuel debris suction collection method

<Identification of issues to be examined>

Item	Issues	Ideas of measures
Piping	Prevention of clogged piping (blockage)	Several manufacturers shared know-how in which internal diameter of piping is three times the size of irregular solid objects or greater to prevent clogging (blockage). Prevention of blockage by adopting piping of such size will be studied.
Pump	Specification of pump flow velocity and capacity	<ul style="list-style-type: none">- Study whether suction is possible with fuel debris suction flow velocity (2 m/s), a precondition specified in section i).- Tentatively specify the diameter of the piping and fuel debris suction flow velocity and study the pump capacity.
	<ul style="list-style-type: none">• Pump clogging prevention (strainer)• Method of detecting, preventing, and resolving clogged pump strainers	Attach a strainer for prevention of clogged pumps so that particles larger than the size of irregular solid objects that can pass through the pump are not sucked in. However, installing a strainer may cause blockages in the strainer itself. Study methods for detecting, preventing, and resolving blockages.
Liquid cyclone separator	Necessity of a liquid cyclone separator	Installation of a liquid cyclone is being considered for an effective collection of particle fuel debris. Study its necessity, taking into consideration the ability to equip it on a robot arm, in addition to the study conducted on pump capacity (discharge pressure) by drop of pressure in the filter.
Filter	Filter mesh size	<ul style="list-style-type: none">• Study the filter mesh size based on the collected particle fuel debris [refer to section i)].• In the study, take into consideration cake filtration and drop of pressure.
Operation	Throughput (desk study)	Find throughput by tabletop calculation from the decline in flow rate of the submersible pump.

6. Implementation details of this project

No.37

6.2. Implementation details

1) Development of Technology for Prevention of Fuel Debris Spreading

(1) Development of Fuel Debris Collection System

a. Methods and means of collecting fuel debris (suction, grabbing, etc.)

- Study of fuel debris suction collection method

<Identification of issues to be examined>

(i) Study of prevention of blockages in piping

Knowledges on clogged pipes caused by irregular solid objects that are obtained from several companies manufacturing submersible pumps are listed below.

- The design condition of the dimensions inside the piping was the same for all manufacturers—**the internal diameter of the piping shall be three times bigger than the irregular solid object or greater** (general knowledge).
- The manufacturers came to the conclusion above **by experience, not logic**.
- Although unlikely, pipes with an internal diameter that is **four times or even five times greater than the irregular solid object sometimes get clogged**.

Based on the results above, the size of the piping is specified as 2 inches with an internal diameter of 50 mm which is five times the maximum size of the fuel debris ($\phi 10$ mm).

However, as piping with a diameter five times greater than the fuel debris may still clog, **a structure with which the piping can be replaced by remote control when it clogs will be studied from the next fiscal year onward**.

6. Implementation details of this project

No.38

6.2. Implementation details

1) Development of Technology for Prevention of Fuel Debris Spreading

(1) Development of Fuel Debris Collection System

a. Methods and means of collecting fuel debris (suction, grabbing, etc.)

- Study of fuel debris suction collection method

<Identification of issues to be examined>

(ii) Specification of pump flow velocity and capacity

To confirm the reliability of the specified fuel debris suction flow velocity (2 m/sec), the flow velocity and capacity of the pump are specified by measuring the terminal settling velocity using sampled particles.

As the particles were transferred in a speed range from about the terminal settling velocity to 1.5 times the terminal settling velocity, **the flow velocity at the maintenance side is specified as $1.75 \text{ m/sec} \times 1.5 = 2.625 \approx 2.7 \text{ m/sec}$.**

(Refer to diagram below)

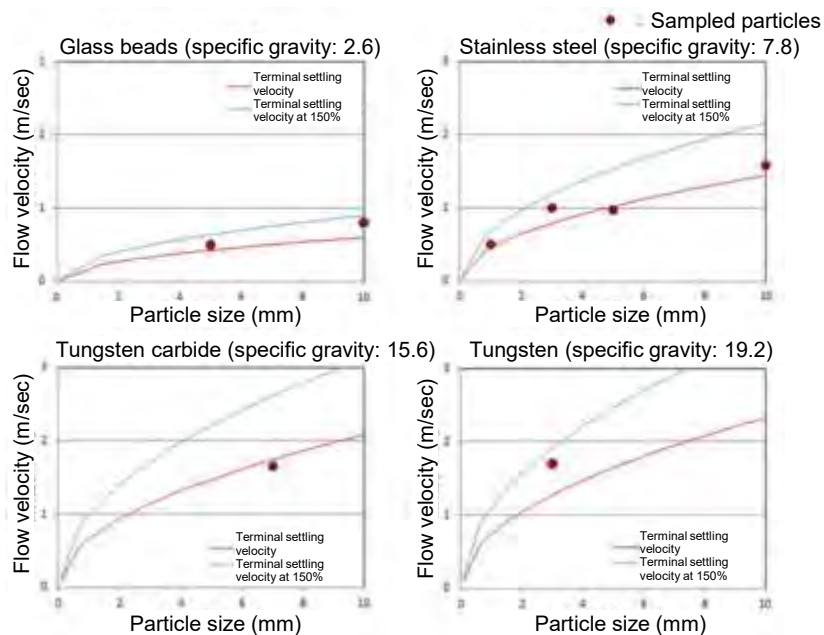

<Results>

- Pump flow velocity: 2.7 m/sec
- Pump capacity: 19.1 m³/h
- Pump mass: 20 kg (provisional)

6.2. Implementation details

1) Development of Technology for Prevention of Fuel Debris Spreading

(1) Development of Fuel Debris Collection System

a. Methods and means of collecting fuel debris (suction, grabbing, etc.)

- Study of fuel debris suction collection method

<Identification of issues to be examined>

(iii) Study of the prevention of blockages in piping

- A submersible pump has an index that indicates the size of an irregular solid object that can be sucked in (**passage diameter**).
- **A protective strainer is installed** so that the pump doesn't suck in an irregular solid object larger than the passage diameter (refer to diagram below).
- Protective strainers are **not designed based on definite grounds but on experience and knowhow of manufacturers**.



Commercial strainers don't have the ideal shape for suction collection system for particle fuel debris. **A study of optimal strainer shape will be conducted through element tests** from next fiscal year onward.

6. Implementation details of this project

No.40

6.2. Implementation details

1) Development of Technology for Prevention of Fuel Debris Spreading

(1) Development of Fuel Debris Collection System

a. Methods and means of collecting fuel debris (suction, grabbing, etc.)

- Study of fuel debris suction collection method

<Identification of issues to be examined>

(iv) Study of methods for detecting and preventing clogged pump strainers

- Irregular solid objects may be sucked into or clog a strainer in a submersible pump during operation.
- As this will impact the operation, a study of ideas on methods for detecting, preventing, and resolving clogged strainers will be conducted.

(a) Idea for detection of clogged pump strainers

A method for detecting clogged strainers using a combination of pressure indicator and flowmeter described in section iii) was studied.

- The flow velocity is believed to decrease and pressure to rise [refer to a)] when the pipe clogs at the downstream of the pump.
- The flow velocity and pressure are believed to decrease [refer to b)] when the strainer clogs because the amount of water transferred will fall.

Such being the case, it is assumed that clogs in strainers can be detected by confirming a fall in pressure when the flow slows down. Detailed study will be conducted by element tests from the next fiscal year onward.

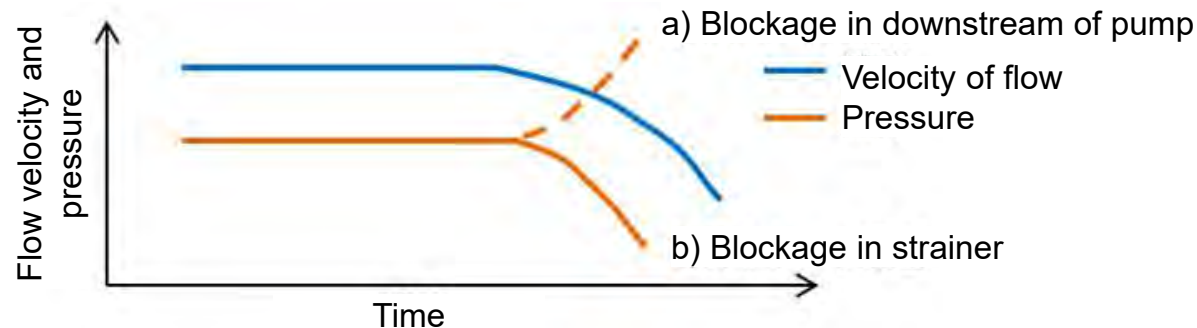

6. Implementation details of this project

No.41

6.2. Implementation details

1) Development of Technology for Prevention of Fuel Debris Spreading

(1) Development of Fuel Debris Collection System

a. Methods and means of collecting fuel debris (suction, grabbing, etc.)

- Study of fuel debris suction collection method

<Identification of issues to be examined>

(b) Plan for prevention of clogged pump strainers

The sizes of different materials that can be sucked by the pump when fuel debris suction velocity is 2.7 m/sec are shown in the table below.

Target materials	Particle size possible for suction (fuel debris suction flow velocity: 2.7 m/sec)	Notes
Concrete	φ60mm	Estimated specific gravity: 2.6
Stainless steel	φ17mm	Estimated specific gravity: 7.9
Uranium dioxide	φ10mm	Estimated specific gravity: 11.0

The following are believed to be effective in preventing large pieces of fuel debris from being sucked into and clogging the strainer.

- Install the structures such as baffles.
- Adopt a structure that prevents large fuel debris from coming into contact with the holes of the strainer.

Strainer shapes that prevents blockages will be studied by element tests from the next fiscal year onward.

6.2. Implementation details

1) Development of Technology for Prevention of Fuel Debris Spreading

(1) Development of Fuel Debris Collection System

a. Methods and means of collecting fuel debris (suction, grabbing, etc.)

- Study of fuel debris suction collection method

<Identification of issues to be examined>

(c) Plan for resolution of clogged pump strainers

The following methods can be considered as a means to resolve clogs.

- Creating a backflow in pumps and piping with the help of gravity by turning the submersible pump on and off.
- Using a axial-flow pump instead of a submersible pump and creating a backflow by reversing direction of rotation of runners in the axial-flow pump.

However, considering the possibility that blockages may not be resolved by backflow, study of a structure that can be easily removed by remote control is believed to be necessary.

Study of method for resolving clogged strainers by turning the pump on and off, applicability of axial-flow pumps, and method of replacing strainers of a submersible pump by remote control will be conducted by element tests from the next fiscal year onward.

6. Implementation details of this project

No.43

6.2. Implementation details

1) Development of Technology for Prevention of Fuel Debris Spreading

(1) Development of Fuel Debris Collection System

a. Methods and means of collecting fuel debris (suction, grabbing, etc.)

- Study of fuel debris suction collection method

<Identification of issues to be examined>

(v) Study of necessity of a liquid cyclone separator

Installation of liquid cyclone separator was considered as an effective measure to collect particle fuel debris, taking into account the possibility of significant initial pressure drop of the filter. However, as its necessity impacts the carrying ability of the robot arm, conditions that do not require the separator were studied.

- If the initial pressure drop of the filter is small and particle fuel debris can be transferred without requiring extreme pump discharge pressure, liquid cyclone separators are not necessary.
- A filter with a mesh size of 0.1 mm or smaller is required to catch particle fuel debris of $\phi 0.1$ mm or larger. However, if particle fuel debris forms a filter cake, filters with a mesh size of 0.1 mm or larger can be used. This will reduce the initial pressure drop of the filter and liquid cyclone separators will not be needed.

The diagram on the right shows a system configuration that doesn't require a liquid cyclone.

The necessity of the liquid separator will be studied by conducting element tests in the next fiscal year onward and verifying the initial pressure drop of the filter and formation of filter cakes.

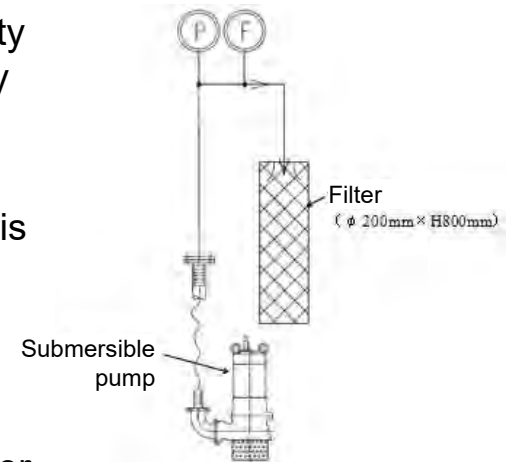

6. Implementation details of this project

No.44

6.2. Implementation details

1) Development of Technology for Prevention of Fuel Debris Spreading

(1) Development of Fuel Debris Collection System

a. Methods and means of collecting fuel debris (suction, grabbing, etc.)

- Study of fuel debris suction collection method

<Identification of issues to be examined>

(vi) Study of filter mesh size

As described in the previous section,

- The size of particle fuel debris is $\phi 0.1$ mm or greater and a filter with a mesh size of 0.1 mm or smaller is required to catch these debris.
- On the other hand, the particle fuel debris caught may form a filtration cake.
- If it is assumed that filtration cake will form, filters with a mesh size of 0.1 mm or greater can be used.

The appropriate filter mesh size will be studied by conducting element tests in the next fiscal year onward and verifying the formation of filter cakes.

6. Implementation details of this project

No.45

6.2. Implementation details

1) Development of Technology for Prevention of Fuel Debris Spreading

(1) Development of Fuel Debris Collection System

a. Methods and means of collecting fuel debris (suction, grabbing, etc.)

- Study of fuel debris suction collection method

<Identification of issues to be examined>

(vii) Study of throughput

Throughput was determined by using the tools on hand to suck and transport fuel debris simulant particles and measuring the amount sucked per unit time. The diagram shown below is a schematic illustration of the configuration of tools used to measure the amount of fuel debris simulant particles sucked per unit time.

The amount of fuel debris simulant particles sucked per unit time was calculated by preparing 45 kg of aluminum oxide particles on the left side of the water tank and measuring the time required to transfer these to the right side of the water tank using a submersible pump.

<Suction conditions>

- Suction flow velocity	2.7 m/s
- Internal diameter of piping	φ50mm
- Capacity	19.1m ³ /h
- Amount of simulant particles	45 kg (φ0.1 to φ10 mm aluminum oxide particles)

<Suction results>

- Suction time	8 minutes 18 seconds
- Amount of suction per unit time	325 kg/h

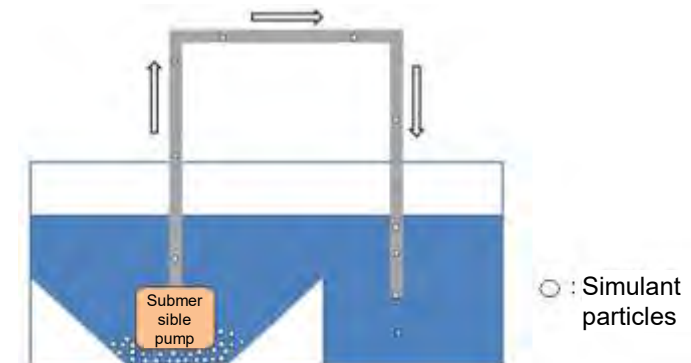

Based on the results, the throughput was determined as 300 kg/h.

6. Implementation details of this project

No.46

6.2. Implementation details

1) Development of Technology for Prevention of Fuel Debris Spreading

(1) Development of Fuel Debris Collection System

a. Methods and means of collecting fuel debris (suction, grabbing, etc.)

- Study of fuel debris suction collection method

Items studied in the next fiscal year onward

In the next fiscal year onward, the following studies will be conducted on issues identified by the research conducted this fiscal year.

Components	Item	Details of study
Piping	Measures against clogging	The internal diameter of piping on the maintenance side will be five times larger than the fuel debris size ($\phi 10$ mm) but structures in which piping can be replaced by remote control will be studied as there is still a risk of piping blockage.
	Strainer shape	A strainer shape that prevents the pump from sucking in fuel debris that exceeds the passage diameter and effectively collects target size debris will be studied by element tests.
Submersible pump	Measures for detecting, preventing, and resolving clogged strainers	Measures for detecting, preventing, and resolving clogged strainers will be studied by element tests.
	Pump type	Feasibility of other types of pumps (e.g., axial-flow pump), not limited to submersible pumps, will be studied.
	Pump replacement method	Structures that allow easy pump replacement in the cell by remote control will be studied to prepare for pump failure.
Liquid cyclone separator	Necessity of a liquid cyclone separator	Liquid cyclone separators may be unnecessary depending on the formation of filtration cakes and thickness of the cake. Details will be studied in element tests.
Filter	Filter mesh size	Appropriate mesh size will be studied in element tests.
	Detection of full filter (clogging)	Clogged or full filters can be detected by combining a flowmeter and a pressure indicator, but these cannot tell which occurred. Therefore, a method for identifying the two states will be studied in element tests.
	Filter replacement method	Structures that allow easy filter removal using remote control robots will be studied.
Operation	Throughput calculation	Throughput of fuel debris that can be sucked or collected will be studied by element tests.

6. Implementation details of this project

6.2. Implementation details

1) Development of Technology for Prevention of Fuel Debris Spreading

(1) Development of Fuel Debris Collection System

a. Methods and means of collecting fuel debris (suction, grabbing, etc.)

-Types of fuel debris that are subject to collection by grabbing and methods of collection

As it is necessary to take into consideration the possibility of fuel debris adhesion even on a structure inside the pedestal, fuel debris that will be grabbed is classified as follows.

- (a) Structure inside the pedestal (including adhered fuel debris)
- (b) Lumps of fuel debris that accumulated at the bottom of the pedestal and doesn't require processing
- (c) Lumps of fuel debris that accumulated at the bottom of the pedestal and requires processing
- (d) Fuel debris that solidified at the bottom of the pedestal (adhered to the bottom)

Whether the fuel debris above requires processing before it is collected in a unit can and if it does, whether it needs to be grabbed during the process are made clear and collection methods were studied.

6. Implementation details of this project

6.2. Implementation details

1) Development of Technology for Prevention of Fuel Debris Spreading

(1) Development of Fuel Debris Collection System

a. Methods and means of collecting fuel debris (suction, grabbing, etc.)

- Types of fuel debris that are subject to collection by grabbing and methods of collection

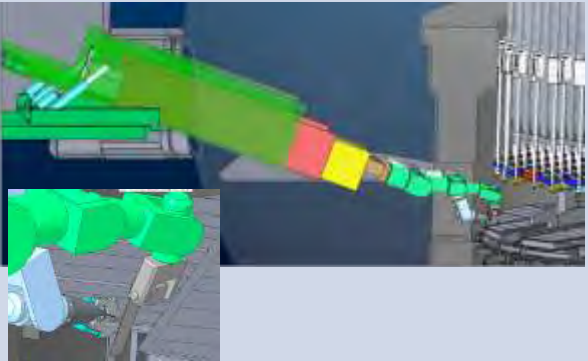
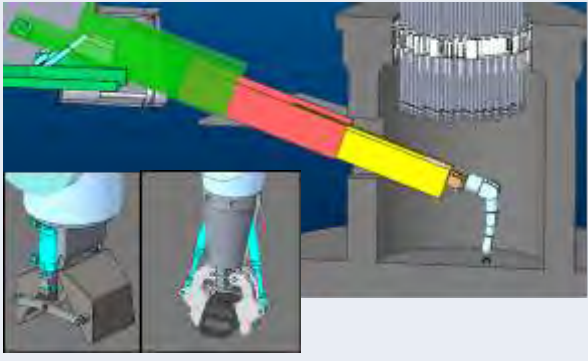
Fuel debris type	Method of collecting	Conceptual image of collection
Structure inside the pedestal (including adhered fuel debris)	<ul style="list-style-type: none"> - Structures need to be processed (cut) for collection while grabbed by a robot arm. To do so, two arms must access the pedestal. One arm grabs the structure while the other cuts. - Using two hydraulic arms is not realistic due to issues concerning dimensions. In addition, electric-powered arms have a wider range of motion which is favorable for accessing structures of complex shape. For these reasons, electric-powered arms will be used. 	
Lumps of fuel debris that accumulated at the bottom of the pedestal and doesn't require processing	<ul style="list-style-type: none"> - Since these don't require processing and can be collected just by grabbing them, only one robot arm is required. - Fuel debris will in principle be collected using a clamshell-bucket-like tool for reduction of time required for collection. - Fuel debris that are difficult to grab (e.g., close to structure) will be collected by picking them up with a tong-like tool. - Both hydraulic and electric-powered arms can be used. However, as the high output power of hydraulic arms is unnecessary, electric-powered arms which are slim and have a wider range of motion will be used. 	

6. Implementation details of this project



6.2. Implementation details

1) Development of Technology for Prevention of Fuel Debris Spreading

(1) Development of Fuel Debris Collection System

a. Methods and means of collecting fuel debris (suction, grabbing, etc.)

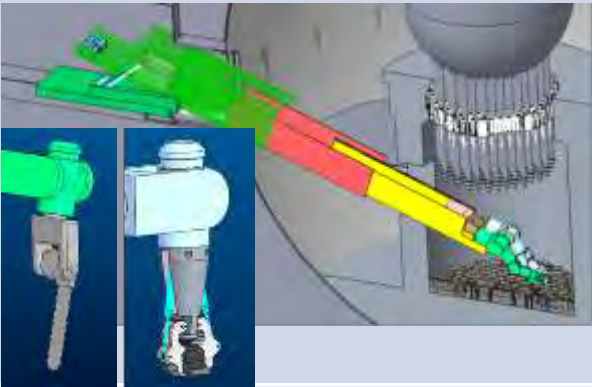
- Types of fuel debris that are subject to collection by grabbing and methods of collection

Fuel debris type	Method of collecting	Conceptual image of collection
<p>Lumps of fuel debris that accumulated at the bottom of the pedestal and requires processing</p>	<ul style="list-style-type: none"> - This requires processing before collected into a unit can. To do so, two arms must access the pedestal. One arm grabs the structure while the other cuts. - Because using two hydraulic arms is not realistic due to issues concerning dimensions, electric-powered arms which are slim and have a wider range of motion will be used. 	
<p>Fuel debris that solidified at the bottom of the pedestal (adhered to the bottom)</p>	<ul style="list-style-type: none"> - This requires processing before collected into a unit can. - The fuel debris can't be grabbed as it is adhered to the pedestal bottom. Therefore, a single arm will access inside the pedestal and process the debris. - Since only one robot arm is required, a hydraulic arm can be used. A high-power hydraulic arm will be used to reduce time required for processing. - After the fuel debris is processed, it will be collected in the same manner as "lumps of fuel debris that collected at the bottom of the pedestal and doesn't require processing." 	

6. Implementation details of this project

6.2. Implementation details

1) Development of Technology for Prevention of Fuel Debris Spreading

(1) Development of Fuel Debris Collection System

b. Method of storing fuel debris in unit cans

- Ways of grabbing fuel debris before collecting into unit cans

Based on the study results of fuel debris collection methods conducted in the previous section, the following three ways are ways in which fuel debris is held before it is collected in a unit can.

(a) Collect using two robot arms; one arm with a tong-like tool that grabs structures or fuel debris in lump form and another with a cutting tool.

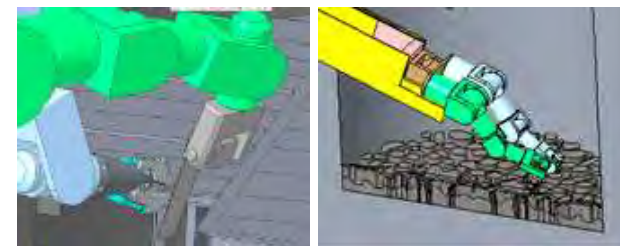

(b) Grab fuel debris using one robot arm with a clamshell-bucket-like tool.

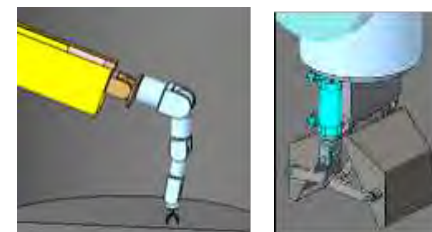

(c) Grab fuel debris using one robot arm with a tong-like tool.



6. Implementation details of this project

6.2. Implementation details

1) Development of Technology for Prevention of Fuel Debris Spreading

(1) Development of Fuel Debris Collection System

b. Method of storing fuel debris in unit cans

- Position of unit can when collecting fuel debris

The following are methods of storing grabbed fuel debris into a unit can on the access rail.

(a) Storing by bringing the grabbing tool near the unit can on the access rail

(b) Storing by removing the unit can off the access rail and bringing it near the grabbing and collection work site

Regarding (b) above, it only has the following demerits and no merits. Therefore, “(a) storing by bringing the grabbing tool near the unit can on the access rail” will be adopted.

- Requires space for placing the unit can
- Requires the unit can to be secured so that it doesn't fall
- Unnecessary task that impacts throughput

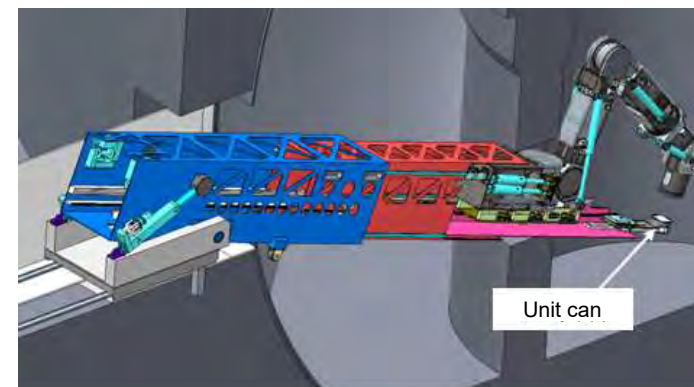

6. Implementation details of this project

6.2. Implementation details

1) Development of Technology for Prevention of Fuel Debris Spreading

(1) Development of Fuel Debris Collection System

b. Method of storing fuel debris in unit cans

- Requirements and measures for collecting fuel debris in unit cans

Requirements	Definition	Notes
Do not spill fuel debris	<ul style="list-style-type: none"> - The robot arm is required to store grabbed fuel debris without spilling to increase throughput. - If fuel debris spills over the access rail, it may affect the operation of the rail. 	*1
Collect an appropriate amount (collect in large quantities within a range which would not spill)	<ul style="list-style-type: none"> - The number of unit can transportation needs to be reduced to increase throughput. - The number of unit cans needs to be minimized in terms of storage space. 	*2

***1:** Regarding the requirement of not spilling, it can likely be fulfilled by releasing the structure or fuel debris in lump form grabbed by a tong-like tool near the unit can. However, if the same method is used for collecting those that are grabbed by a clamshell-bucket-like tool, some may spill as the unit can is small ($\phi 200$ mm).

Measures were studied and the results suggested a common method of using a funnel to put them into a small container without spilling. Therefore, as only one arm is used when collecting with a clamshell-bucket-like tool, a decision was made to install another arm for holding a funnel.

***2:** Regarding the requirement of collecting an appropriate amount, it can likely be fulfilled by monitoring the container with a camera attached to the robot arm tip.

6. Implementation details of this project

6.2. Implementation details

1) Development of Technology for Prevention of Fuel Debris Spreading

(1) Development of Fuel Debris Collection System

b. Method of storing fuel debris in unit cans

- Study of method for collecting fuel debris in unit cans

In the adopted method, a tong-like tool grabs structures and fuel debris in lump form, then releases and stores them in unit cans on the access rail.

When using clamshell-bucket-like tools, one arm which has the tool grabs fuel debris in lump form and the other holds a funnel-shaped container in which collected fuel debris are stored without spilling.

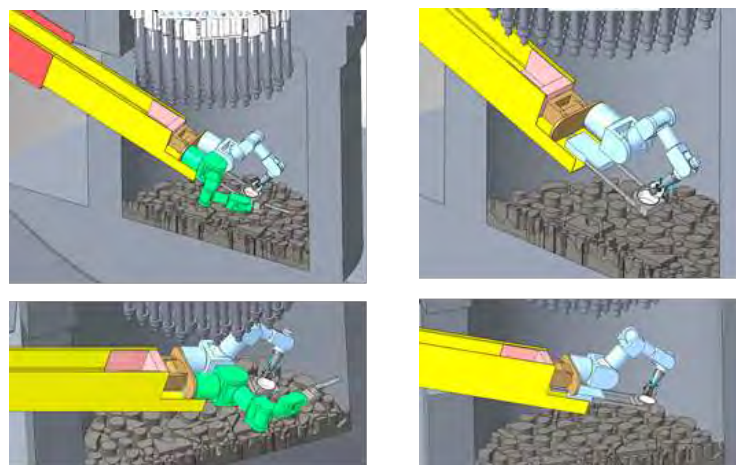

(Processed while collecting) (Processing not necessary)

Storing fuel debris in unit cans using a tong-like tool

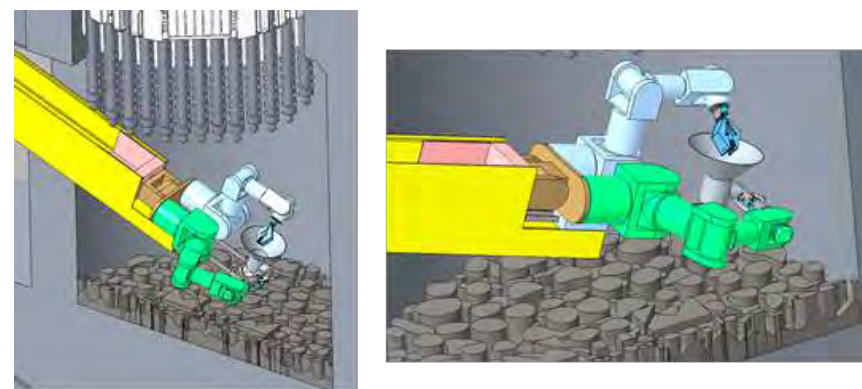

Storing fuel debris in unit cans using a clamshell-bucket-like tool

6. Implementation details of this project

6.2. Implementation details

1) Development of Technology for Prevention of Fuel Debris Spreading

(1) Development of Fuel Debris Collection System

c. Method of adjusting water content of fuel debris (dehydration, drying, etc.)

Method of adjusting water content of fuel debris was observed based on the results of tests and analysis conducted by the Canister Project Team.

(i) Overview of the dehydration test using unit cans (conducted by the Canister Project Team)

A dehydration test was conducted using a fuel debris simulant and a unit can mock-up in which a wire net is placed at the bottom to imitate a unit can.

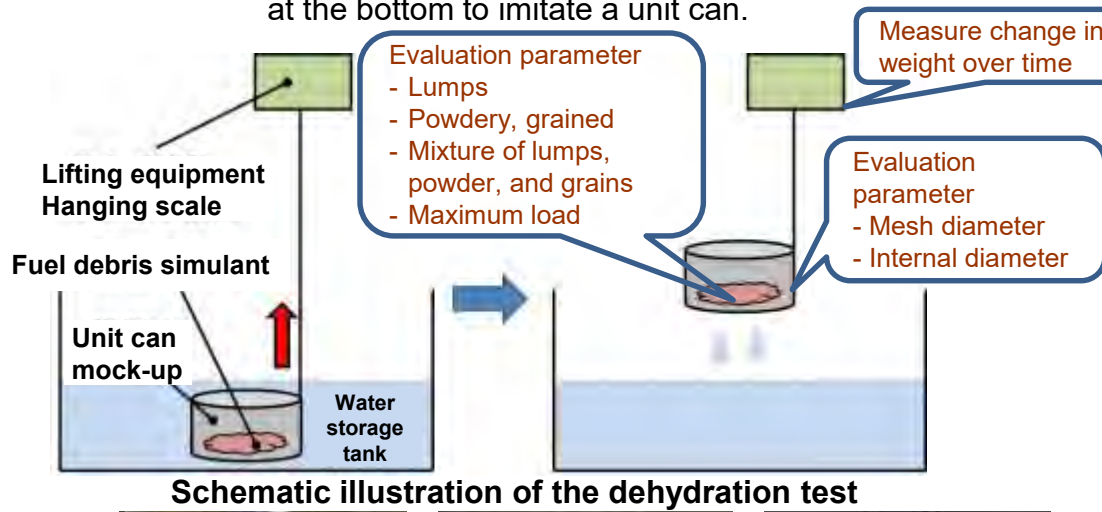

Before test

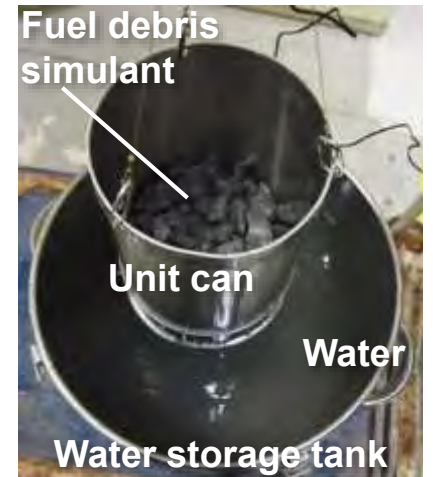

After test

Dehydration test



(a) Simulant size: 20 to 40 mm

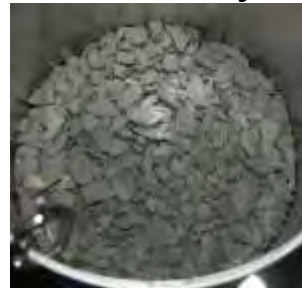

(b) Simulant size: 5 to 15 mm



(c) Simulated simulant size distribution* (mainly simulants of 5 mm or smaller)

Fuel debris simulant

6. Implementation details of this project

6.2. Implementation details

1) Development of Technology for Prevention of Fuel Debris Spreading

(1) Development of Fuel Debris Collection System

c. Method of adjusting water content of fuel debris (dehydration, drying, etc.)

(ii) Matrix of the dehydration test using unit cans (conducted by the Canister Project Team)

Size of opening of wire mesh at bottom of the unit can: 0.09 to 8 mm (reference: size of fuel debris within scope of collection 0.1 mm)

Fuel debris: lump form (20 to 40 mm), particle and grained (5 to 15 mm), particle and grained (simulated the assumed particle size distribution of the actual fuel debris*)

No.		1	2	3	4	5	6	7	8	9	10	11
Fuel debris simulant	Shape	Lumps			Particle, grained (even)				Particle, grained (distributed)			Particle, grained (even)
	Fuel debris size	20 to 40 mm			5 to 15 mm				Simulated the simulant size distribution*			5 to 15 mm
Unit can mock-up	Internal diameter (mm)	150	200	200	150	150	200	200	150	150	150	200
	Mesh diameter (mm)	4	4	8	4	8	4	8	0.09	4	4	4
Test condition	Target loading height of fuel debris simulant	Approx. 100 mm						Approx. 20 mm			Approx. 100 mm	
	Duration of submersion before dehydration	30 minutes									24 hours	

* Simulated the particle size distribution obtained from the results of test on metal ceramic slag conducted by the Fuel Debris Characterization Project Team in FY2015 (graph on right)

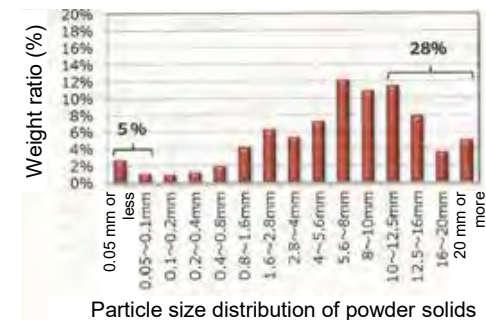

6. Implementation details of this project

No.56

6.2. Implementation details

1) Development of Technology for Prevention of Fuel Debris Spreading

(1) Development of Fuel Debris Collection System

c. Method of adjusting water content of fuel debris (dehydration, drying, etc.)

(iii) Measurement results of amount of residual water (conducted by the Canister Project Team)

The amount of residual water varied significantly depending on the form of the fuel debris, and the water volume exceeded 50% even after the debris had been dewatered.

==> Relaxation of safety assessment by dehydration cannot be expected, taking into account the after-mentioned criteria.

(The realistic purpose of dehydration would be to prevent the spread of contamination and to reduce the time required for drying.)

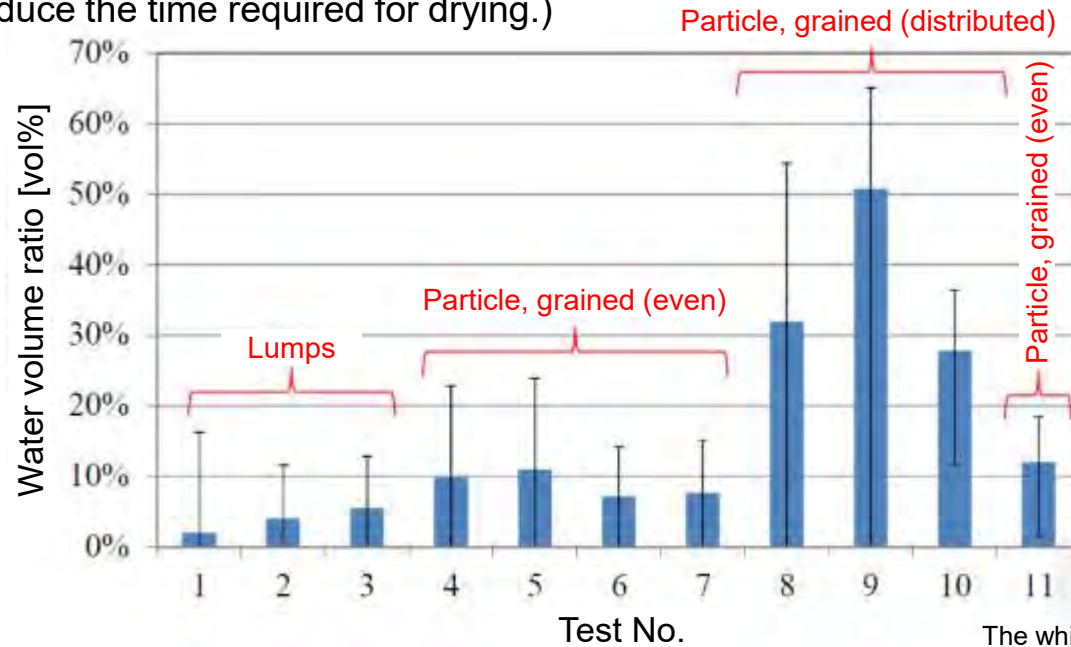

Results of dehydration verification test

The whiskers show the range of water volume ratio taking into account the errors (measurement error of hanging scale, amount of water that adhered to the unit can mock-up).

6. Implementation details of this project

No.57

6.2. Implementation details

1) Development of Technology for Prevention of Fuel Debris Spreading

(1) Development of Fuel Debris Collection System

c. Method of adjusting water content of fuel debris (dehydration, drying, etc.)

(iv) Measurement results of dehydration time (conducted by the Canister Project Team)

The amount of residual water almost stabilizes at around two minutes and no significant difference was observed between the amount measured after 10 minutes and 30 minutes.

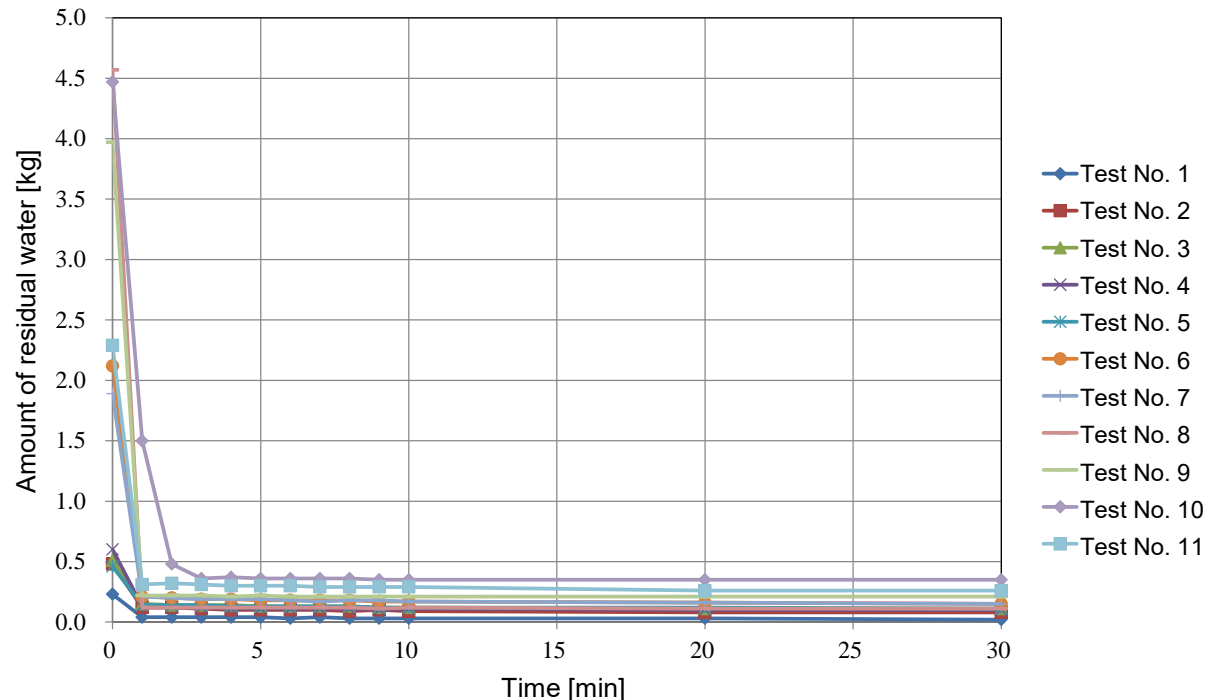

Change in amount of water over time

6. Implementation details of this project

No.58

6.2. Implementation details

1) Development of Technology for Prevention of Fuel Debris Spreading

(1) Development of Fuel Debris Collection System

c. Method of adjusting water content of fuel debris (dehydration, drying, etc.)

(v) Evaluation of the allowable amount of residual water in terms of criticality safety (conducted by the Canister Project Team)

The below shows the results of the survey (example) on restrictions of canister dimensions (internal diameter and height) and amount of water inside canisters in terms of criticality safety.

The patterns of maldistribution (unevenness) of fuel debris and water expected to occur inside the canister is limitless. In this study, from the viewpoint of verifying the effectiveness of dehydration inside the canister, the allowable amount of water in terms of maintaining sub-criticality was surveyed assuming that water collects at the bottom of the canister.

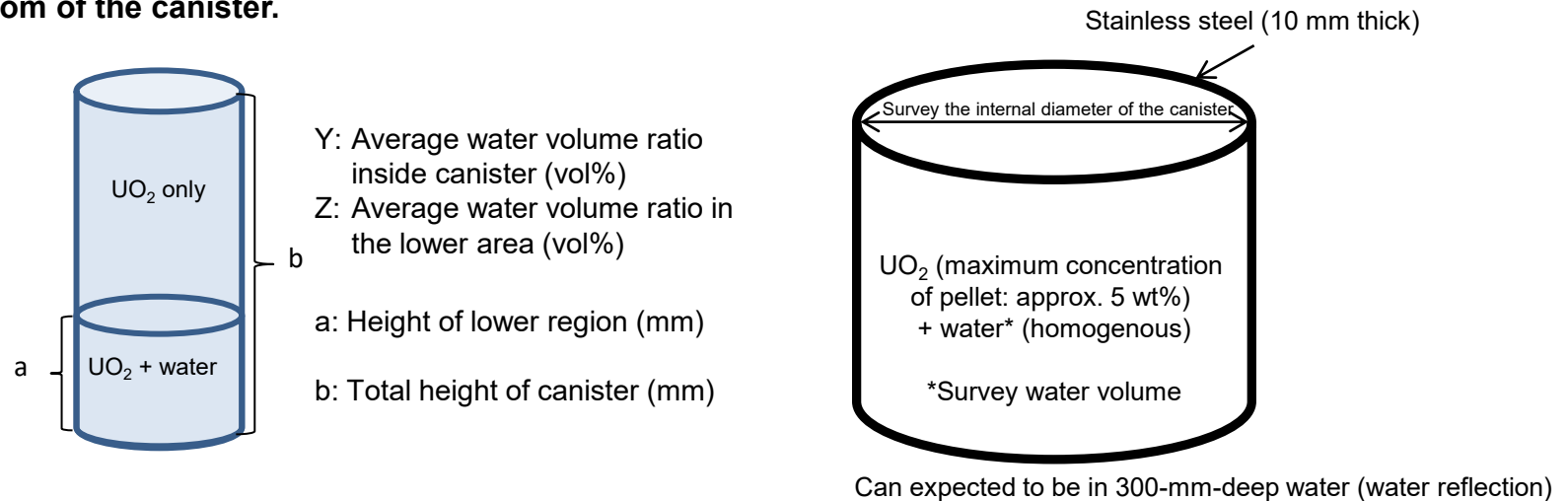

Sub-criticality evaluation model (region a in left diagram)

In this evaluation, all the residual water in the canister is assumed to have a concentration of 4.9 wt% and be in optimum moderation with UO₂ at the bottom of the canister.

(The internal diameter of the canister in which sub-criticality can be maintained was surveyed based on the specified height of the lower region [$a (=b*Y/Z)$] calculated according to the average water volume inside the can [Y] and the moisture content [average water volume in the lower region] [Z] that achieves optimum moderation which is calculated separately.)

6. Implementation details of this project

No.59

6.2. Implementation details

1) Development of Technology for Prevention of Fuel Debris Spreading

(1) Development of Fuel Debris Collection System

c. Method of adjusting water content of fuel debris (dehydration, drying, etc.)

(v) Evaluation of the allowable amount of residual water in terms of criticality safety (conducted by the Canister Project Team) (continued)

According to the study conducted on the assumption that residual water collects at the bottom of the canister, the amount of residual water needs to be about 8 % (when canister height is 1,500 mm) in order to use a canister with an internal diameter of 400 mm.

==> This amount is difficult to achieve by dehydration (in addition, there are an unlimited number of conditions for unevenness and the condition which the study is based on may not be the most strict condition).

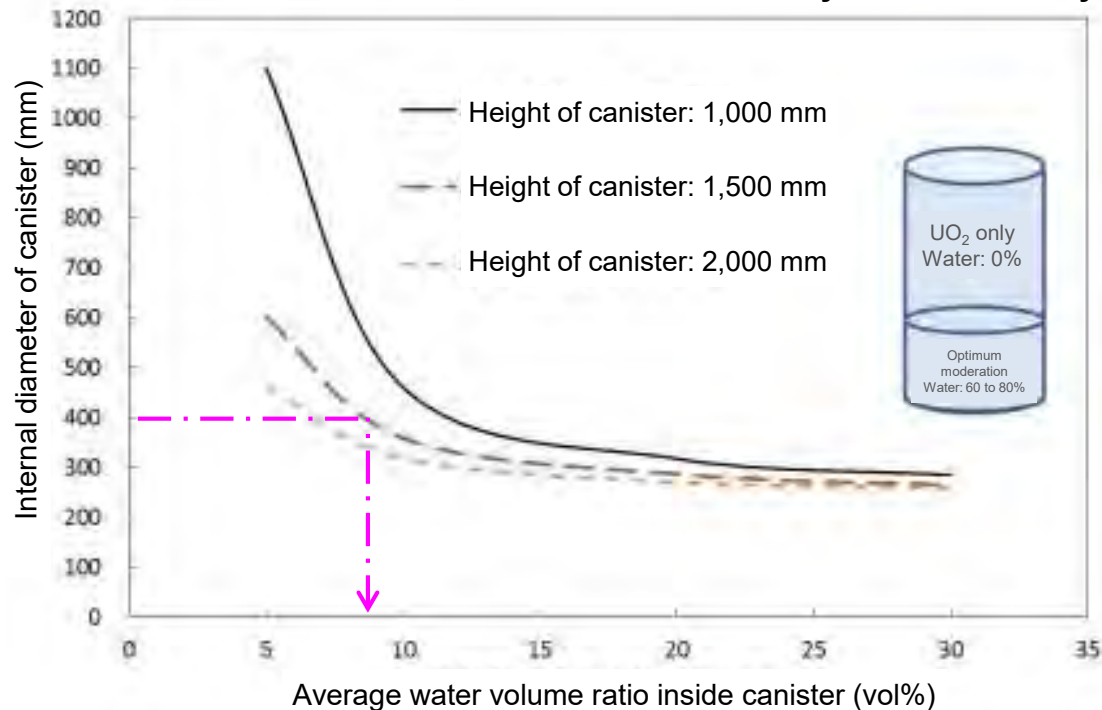

The internal diameter of the canister against the average water volume ratio inside the canister, when all the residual water in the canister is assumed to have a concentration of 4.9 wt% and be in optimum moderation with UO₂ at the bottom of the canister

6. Implementation details of this project

6.2. Implementation details

1) Development of Technology for Prevention of Fuel Debris Spreading

(1) Development of Fuel Debris Collection System

c. Method of adjusting water content of fuel debris (dehydration, drying, etc.)

(v) Evaluation of the allowable amount of residual water in terms of measures for hydrogen generation (conducted by the Canister Project Team)

In a study of the amount of hydrogen generated by radiolysis, the amount of hydrogen generated from dewatered fuel debris (amount of water: 8 ml) was not much different from those generated from submersed fuel debris (amount of water: 100 ml). (Reduction in the amount of hydrogen generated can't be expected by dehydration alone.)

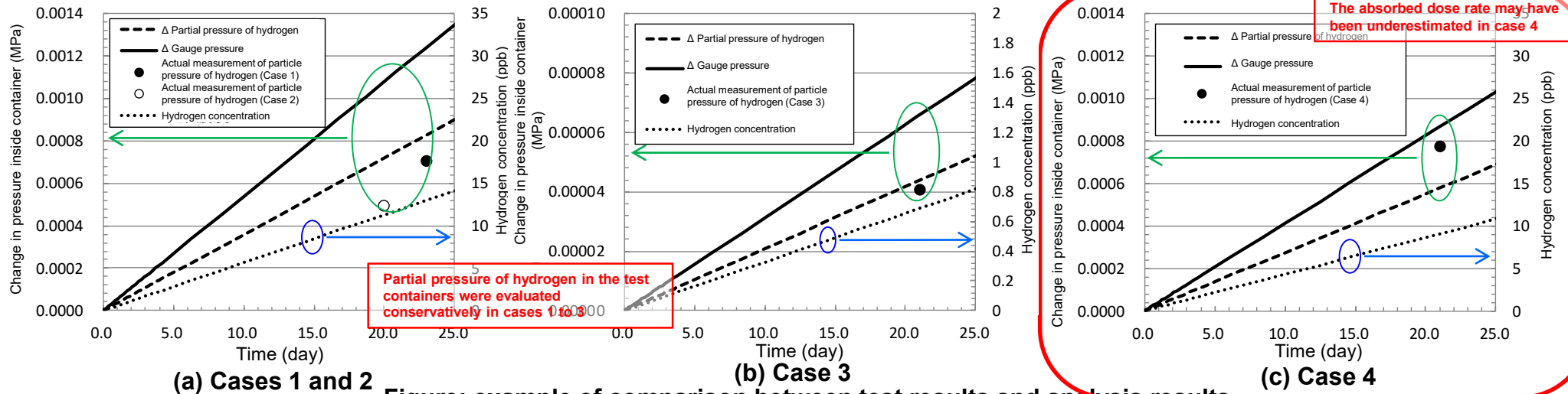

Figure: example of comparison between test results and analysis results

Table: Analysis conditions

Item	Cases 1 and 2	Case 3	Case 4	Notes
Absorbed dose rate	α-ray	21.5 Gy/h	—	Determined by the speed of hydrogen production (average) obtained from the test results
	β-ray, γ-ray	4.7 Gy/h	4.0 Gy/h	
Water volume	100 mL		8 mL	Used to calculate hydrogen concentration in gas phase (not taken into account in the analysis using the radiolysis model)
Sea water concentration	Chloride ion concentration equivalent to 5.6×10^{-4} mol/L (20 ppm)			Test conditions
Iodide ion concentration	1.0×10^{-4} mol/L			Test conditions
Temperature	25°C			Room temperature
Time	20 days			Test conditions

6. Implementation details of this project

No.61

6.2. Implementation details

1) Development of Technology for Prevention of Fuel Debris Spreading

(1) Development of Fuel Debris Collection System

c. Method of adjusting water content of fuel debris (dehydration, drying, etc.)

(vi) Discussion (summary and issues)

Discussions were held based on the results of study made by the Canister Project Team.

- The dehydration work is not expected to require a long period of time.
(In the test conducted by the Canister Project Team, the effect of dehydration reached saturation at about two minutes under the conditions of the loading height of the fuel debris simulant [max. 100 mm]. The height of the actual unit can is about two to four times larger than the loading height. Assuming that the time required for dehydration and the loading height is proportional, the effect of dehydration is expected to reach saturation at around 10 to 20 minutes.)
- However, the amount of water lost by dehydration is likely not enough to relax the sub-criticality conditions or reduce the amount of hydrogen generated. The realistic objective of carrying out this process is to prevent the spread of contamination and to reduce the time required for drying for dry storage.
- Taking into account the above, adjustments are needed to create a concrete guideline for the dehydration task (timing, location, etc.).
- A drying work is likely required to reduce the amount of water to a sufficient level for relaxing the sub-criticality conditions or reducing the amount of hydrogen generated. The Canister Project Team is currently studying the drying guidelines, etc. and specific methods and locations of implementation need to be developed in the future based on the results.

6. Implementation details of this project

6.2. Implementation details

1) Development of Technology for Prevention of Fuel Debris Spreading

(1) Development of Fuel Debris Collection System

d. Method of storing and transferring canisters containing unit cans

- Assumed specifications of unit can and storage canister

● Unit can specifications:

- The unit can shall be designed so that it can dehydrate the fuel debris inside.
- The basic outer dimension shall be $\phi 210$ mm (size that can be collected in a canister).
- The height shall be adjustable according to the method (maximum size: 800 mm; size that can be collected in a canister).
- The handling mechanism shall also be studied according to the method.

● Canister specifications:

- The basic outer dimension (body) shall be $\phi 230$ mm.
- The height shall be 1,000 mm or lower. Studies of concretization along with lid structure will be conducted by the Canister Project Team in the future.



Unit can

Reference example of unit can

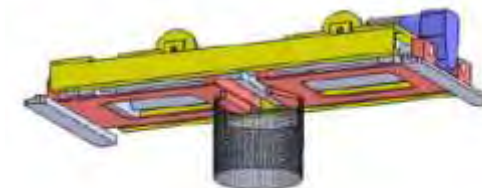

Reference example of secured unit can



Storage canister

Reference example of canister

Assumed unit can specifications

- Outer dimension: $\phi 210$ mm \times 200 mm
- Weight (dry): 10 kg
- Maximum amount of fuel debris collected: 50 kg
- Average amount of fuel debris collected: 15 kg
- Maximum total weight: 60 kg

Assumed canister specifications

- Outer dimension: $\phi 340$ mm \times 960 mm
- Weight (dry): 200 kg
- Maximum number of unit cans collected: 4
- Maximum amount of fuel debris collected: 200 kg
- Average amount of fuel debris collected: 60 kg
- Maximum total weight: 440 kg

6. Implementation details of this project

6.2. Implementation details

1) Development of Technology for Prevention of Fuel Debris Spreading

(1) Development of Fuel Debris Collection System

d. Method of storing and transferring canisters containing unit cans

- Handling of unit can and storage canister

- Unit can: Handled in high-level contaminated areas.
- Storage canister: Handled in mid-level contaminated areas.
- Cask: Handled in low-level contaminated area.

- Issues regarding transfer of unit can and storage canister

- In collecting fuel debris, large amounts are transported repeatedly over a long period of time. It is necessary to minimize the spread and accumulation of contamination associated with each fuel debris collection task.
- Contaminants may adhere to the surface of the canister and contaminate it when it is brought into contaminated areas to store unit cans inside.
- Similarly, casks may also get contaminated on the surface when brought into mid-level contaminated areas to store canisters.

If surface contamination is not measured and decontamination work is not conducted, the contamination level inside the cell will gradually increase and as a result, worker exposure will increase during maintenance, etc.

When transporting containers across different contamination areas

- Measure the surface contamination and ensure that the container is not contaminated.
- If the surface is contaminated, decontaminate the surface until the contamination level falls below the specified value.

Measurement of surface contamination and decontamination work require a long amount of time and have great negative impact on throughput.

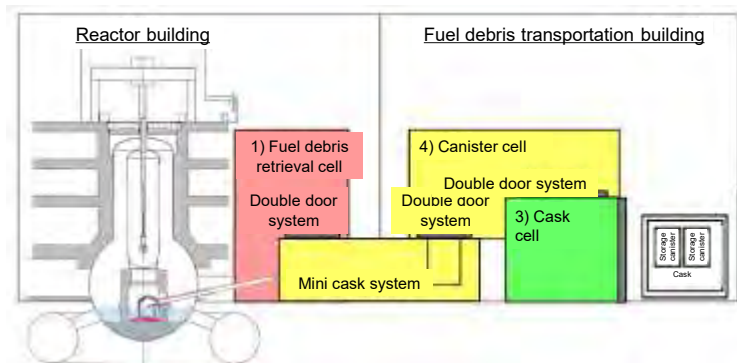

	High-level contaminated area:	Area where the device handles fuel debris and waste without them sealed inside a container.
	Mid-level contaminated area:	Area where the device handles fuel debris in canisters or area that is directly connected to high-level contaminated areas.
	Low-level contaminated area:	Area where the device handles sealed fuel debris.

6. Implementation details of this project

6.2. Implementation details

1) Development of Technology for Prevention of Fuel Debris Spreading

(1) Development of Fuel Debris Collection System

d. Method of storing and transferring canisters containing unit cans

Methods for packing unit cans in a canister and transporting canisters were studied with the following in mind:

- Suppress the spread of contamination that accompany the fuel debris collection task.
- Transport the canister promptly and effectively to improve throughput.

The following is possible by adopting the double door system:

- Unit cans and canisters can be stored without transporting them to areas of high contamination.
- The risk of contamination spreading is reduced by transporting items while maintaining its airtightness.
- Reduction in time required for measuring contamination and conducting decontamination work will improve throughput.

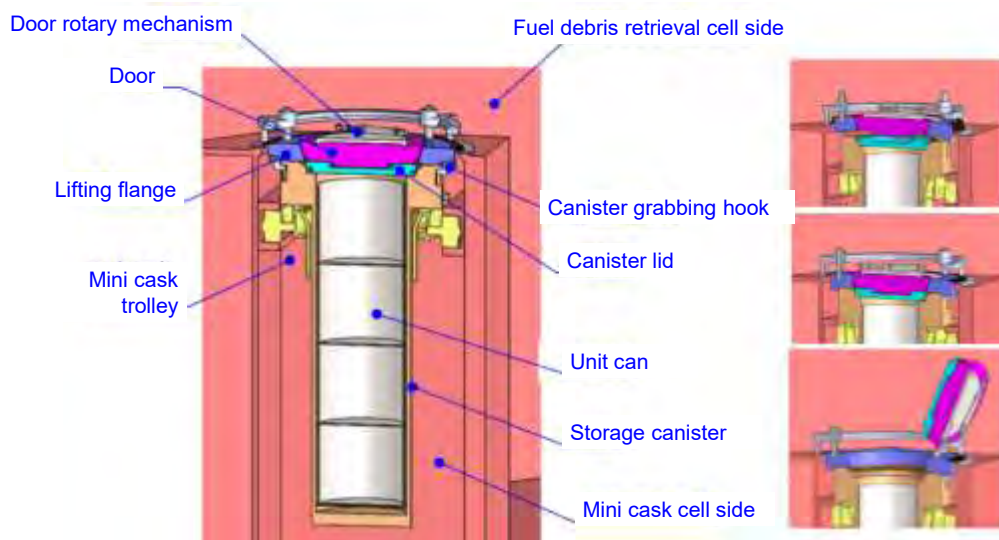

Example of a double door of a canister

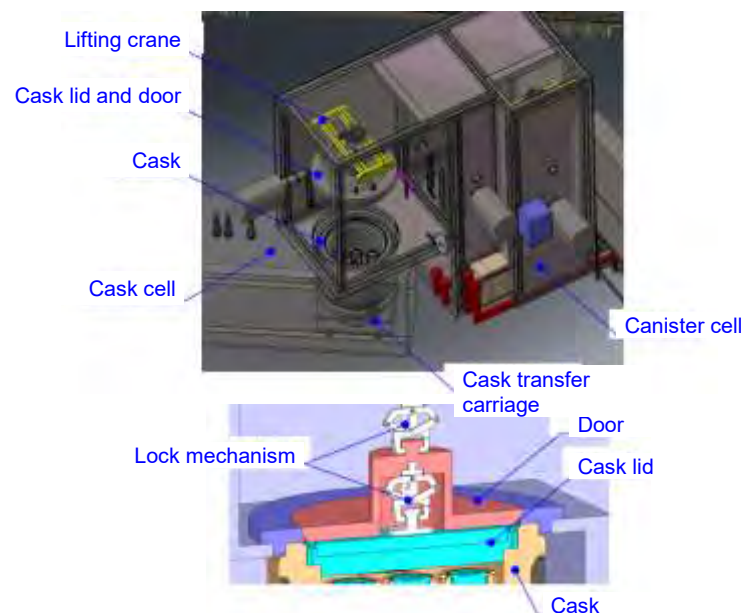

Example of a double door of a cask

6. Implementation details of this project

6.2. Implementation details

1) Development of Technology for Prevention of Fuel Debris Spreading

(1) Development of Fuel Debris Collection System

d. Method of storing and transferring canisters containing unit cans

- Unit cans containing collected fuel debris are transported from the PCV to the fuel debris retrieval cell by a unit can carriage on the access rail.
- It is then collected from the access rail by a crane with a manipulator in the fuel debris retrieval cell, transported to the mini cask cell via the double door, and stored in an awaiting canister.

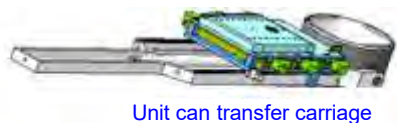
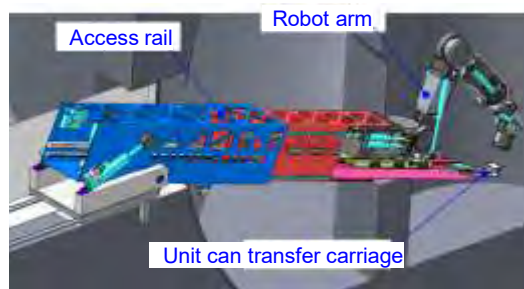
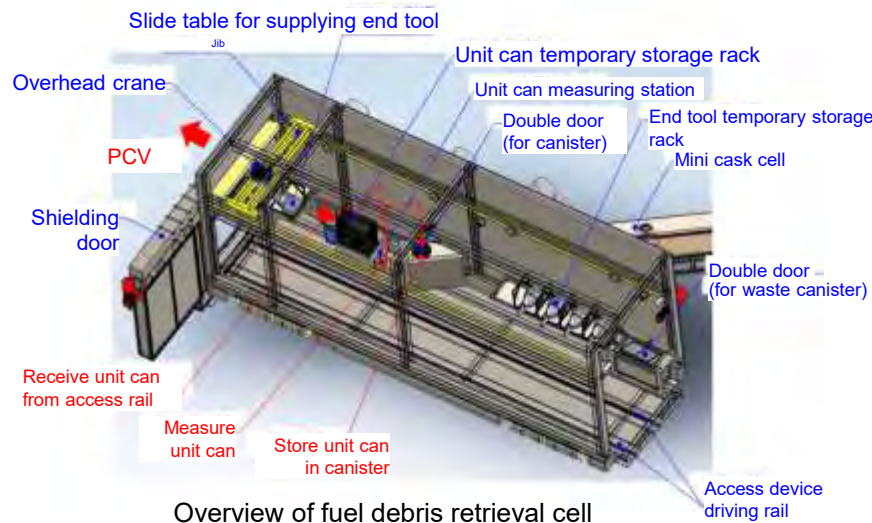

Profile of an access rail and a unit can transfer carriage

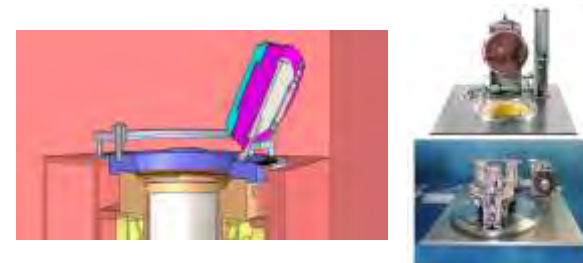
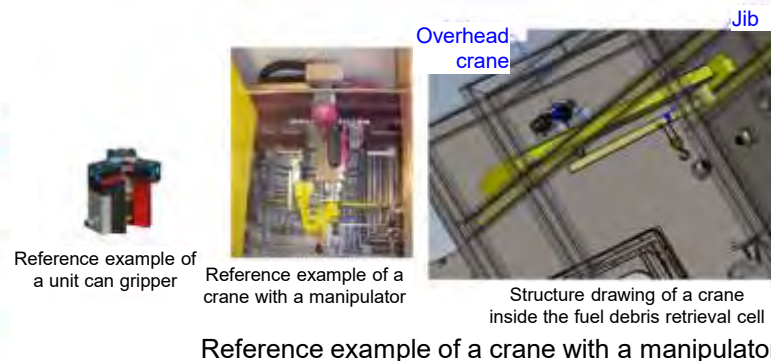
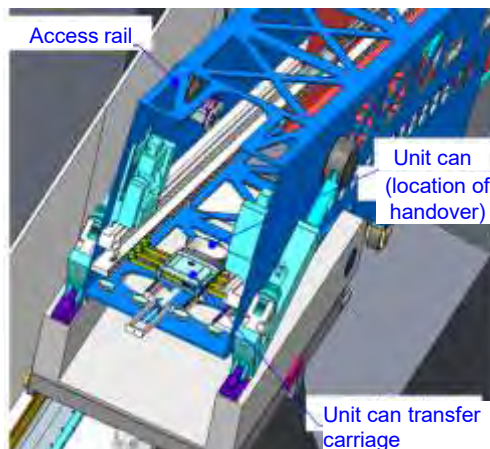

6. Implementation details of this project

6.2. Implementation details

1) Development of Technology for Prevention of Fuel Debris Spreading

(1) Development of Fuel Debris Collection System

e. Study of other fuel debris collection methods (study of collection by sweeping up fuel debris with rotary brushes)

A collection method in which rotary brushes sweep up particle debris and fuel pellets was investigated for its performance.

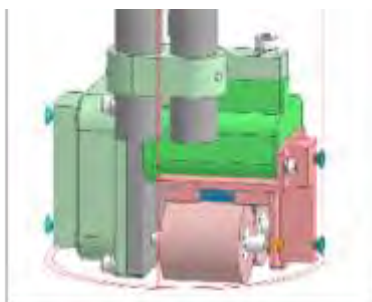
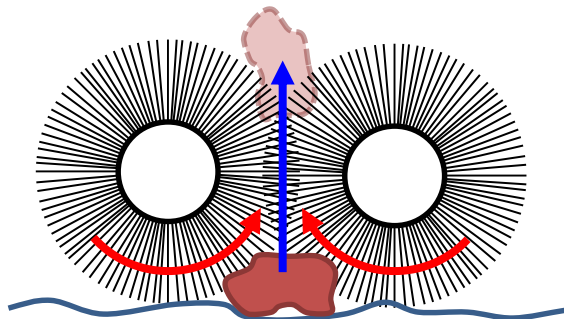

Investigation conditions

Test pieces: ϕ 3, 5, and 10 mm SUS balls

Brush material: nylon 610

Rotational frequency of brush: approx. 50 rpm

Brush dimensions: approx. ϕ 20 mm, 20 mm in width

Pushing force of brush: approx. 24 N

Results

Sweep-up method using ϕ 20 mm rotary brushes can likely collect 5 and 10 mm fuel debris.

Issues

Improve range of fuel debris sizes (smaller fuel debris, etc.) that can be collected, determine a method for collecting swept-up fuel debris

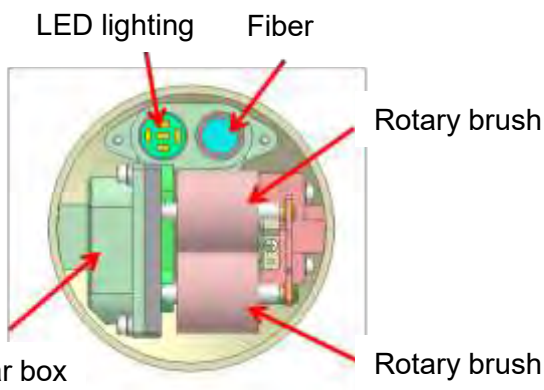

ϕ 5 mm SUS balls (approx. 0.5 g): Possible to collect

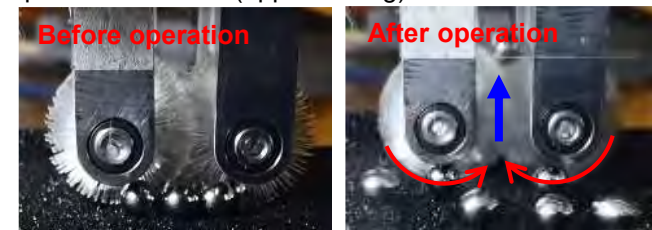

ϕ 10 mm SUS balls (approx. 4.1 g): Possible to collect



ϕ 5, 10 mm: Possible to collect

ϕ 3 mm (approx. 0.1 g): Not possible to collect

Cause: The contact surface against brush might be insufficient

6. Implementation details of this project

6.2. Implementation details

1) Development of Technology for Prevention of Fuel Debris Spreading

(1) Development of Fuel Debris Collection System

(2) Development of Fuel Debris Cutting / Dust Collection System

(3) Development of Prevention Method of Fuel Debris Spreading

2) Development of Element Technology for Retrieval Device Installation

(1) Development of Element Technology for Work Cells

(2) Development of Interference Object Removal during Fuel Debris Retrieval

3) Development of Remote Maintenance Technology for Fuel Debris Retrieval Device

6. Implementation details of this project

6.2. Implementation details

1) Development of Technology for Prevention of Fuel Debris Spreading

(2) Development of Fuel Debris Cutting / Dust Collection System

Cutting methods with cutting performance data are available through cutting performance test results, including cutting tests of fuel debris simulant ceramics, metal-concrete mixtures, and contaminated structures. These will be subjected to cutting performance tests to obtain data, including the amount and particle size distribution of chips and dust generated by those methods. In addition, dust collection systems will be developed to match the processing methods developed through the above-mentioned activities, and data on the efficiency of collecting chips and dust generated by these methods will be obtained.

a. Listing of possibly effective processing methods with consideration of fuel debris characteristics and study of the listed methods

- Processing and processing methods that match different fuel debris characteristics were listed.
- Effective processing methods will be selected from the list.

b. Processing element tests with fuel debris simulant by effective processing methods

- Processing elements tests on chisel processing and ultrasonic core boring were conducted.

c. Production of fuel debris and contaminated structure simulants for processing tests

- MCCI debris simulants used in the processing element test were manufactured and used in the processing test.

d. Study and analysis of dust collection systems used for chips and dust generated during processing

- The local dust collection system used to collect chips, crumbs, and dust produced in cutting and processing is being studied as a measure to prevent fuel debris diffusion.
- Liquid waste was analyzed to find the particle size distribution of chips and crumbs produced in the processing element test.

6. Implementation details of this project

6.2. Implementation details

1) Development of Technology for Prevention of Fuel Debris Spreading

(2) Development of Fuel Debris Cutting / Dust Collection System

● Purpose of development

- Acquisitions of data necessary to analyze the advantages and disadvantages of processing technologies applicable to fuel debris processing
 - ✓ Cutting performance (such as cutting speed) as well as the amount and particle size distribution of chips and dust produced
 - ✓ Development of a dust collection system

● Approaches to development

- Conceptual study of potentially effective processing methods with consideration of fuel debris characteristics
- Selection of MCCl debris simulants to be processed (e.g., ceramics, metal-concrete mixtures, contaminated structures)
- Cutting performance tests (to obtain data, including the amount and particle size distribution of chips and dust generated by cutting work)
- Development of a dust collection system (including data collection concerning the efficiency of the system for collecting the chips and dust generated)

● Expected outcome

- Determination of processing methods, each of which fit with different fuel debris characteristics
- Processing data for studying throughput
- Study result of local collection system (chips, crumbs and dust spread prevention)
- Analyzation results of particle size distribution in processing liquid waste

6. Implementation details of this project

6.2. Implementation details

1) Development of Technology for Prevention of Fuel Debris Spreading

(2) Development of Fuel Debris Cutting / Dust Collection System

● Issues to be resolved (essential factors in selecting fuel debris cutting technologies)

	Requirements	Essential factors in the selection of fuel debris cutting technologies
Safety requirements*	Prevention of the abnormal generation of radioactive materials caused by nuclear reaction	(There is no comparative data since every cutting method entails a risk)
	Prevention of the emission of radioactive materials due to abnormal temperature rise in fuel debris	Heat input to fuel debris shall be small (Especially, assessment is required for thermal processing methods)
	Prevention of abnormal diffusion of radioactive materials caused by cutting fuel debris and structures	Fewer fumes (powders, fine particles, etc.) shall be emitted into the atmosphere Fewer chips, crumbs and powders shall be emitted under water
Task requirements	Ability to process various types of fuel debris, such as fuel assemblies including fuel pellets and fuel claddings, reactor internals, RPV, and concrete	The method should enable processing without being affected by fuel debris characteristics, such as electric conductivity (conductive or non-conductive), mechanical properties (hardness, etc.), and thermal properties (melting point, boiling point)
	Ability to minimize the time required to retrieve fuel debris	The processing speed must be high
	Ability to reach fuel debris lying in narrow areas inside the RPV and PCV	The processing device (especially its head on the tip) shall be small
	Little impact on the plant operation systems and infrastructure	Supply of assist gas and other utilities shall be small
		Water supply and abrasive particles contained in AWJ shall be small
	High feasibility of work area	Only few utilities shall be required and the scale of auxiliary facilities shall be minimal
Availability of technology	Technology shall still be available from a vendor	

*Requirements relevant only to fuel debris processing are excerpted from all safety requirements

- Promising processing methods are picked up based on essential selection factors, and element tests are performed for each method.
- Then, the line of processing technologies must be prepared for device design and adopted depending on the accessibility to debris locations.

6. Implementation details of this project

6.2. Implementation details

1) Development of Technology for Prevention of Fuel Debris Spreading

(2) Development of Fuel Debris Cutting / Dust Collection System

a. Listing of possibly effective processing methods with consideration of fuel debris characteristics and study of the listed methods

: methods that received good evaluation for fuel debris processing

	Applicability to various fuel debris	Processing speed	Accessibility (small head)	Heat input	Fume generation (aerial diffusion)	Amount of chips and crumbs generated (underwater diffusion)	Downsizing of utilities	Availability	Total evaluation and element tests
Core boring	○	△	○	○	○	△	○	○	○
Circular saw	○	○	△	○	○	○	○	○	○
Wire saw	△	△	×	○	○	○	○	○	
Band saw	△	△	×	○	○	○	○	○	
Ultrasonic core drill	△	△	○	○	○	△	○	○	○
Hydraulic cutter	△	○	○	○	○	△	○	○	○
Chisel	△	○	○	○	○	○	○	○	○
AWJ	△	△	○	○	○	×	×	○	○
Laser gouging	○	△	○	△	△*	△	×	○	○
Plasma arc	×	×	○	△	×	△	×	○	
Plasma jet	○	△	○	△	×	△	×	×	
Gas	×	△	○	△	×	△	△	○	
Contact arc	×	×	○	△	×	△	△	△	
Arc saw	×	×	×	△	×	△	△	△	
Consumable electrode WJ	×	×	○	△	×	△	×	△	
Laser boring	○	△	○	○	×	△	×	△	

Processing methods selected from the perspective of processing MCCI fuel debris at the bottom of the PCV

* It was confirmed, based on the outcome of research activities in last fiscal year, that even when laser gouging is performed in air, aerial diffusion of chips and dust generated by the process can be inhibited by washing the chips and dust at the PCV bottom by water.

6. Implementation details of this project

6.2. Implementation details

1) Development of Technology for Prevention of Fuel Debris Spreading

(2) Development of Fuel Debris Cutting / Dust Collection System

b. Processing element tests with fuel debris simulant by effective processing methods

(1) Processing element test with chisels

- General information about chisel processing
 - A processing method in which target materials are crushed by hitting them with a chisel attached to the front end of a heavy machinery. It is widely used at civil engineering work sites.
 - It is generally used to bore through bedrock, break rocks into small pieces, and crush concrete.
 - In FY2015 to FY2016, preliminary tests in which concrete blocks are crushed using a combination of a muscular robot and chisel processing were performed.



Crushing a concrete block using the chisel processing method

6. Implementation details of this project

6.2. Implementation details

1) Development of Technology for Prevention of Fuel Debris Spreading

(2) Development of Fuel Debris Cutting / Dust Collection System

b. Processing element tests with fuel debris simulants by effective processing methods

(1) Processing element test with chisels

- Purpose of development
 - Verification of the chisel processing method's applicability to fuel debris retrieval.
 - ✓ Improvement of efficiency in collecting MCCI fuel debris, which make up the majority of the fuel debris.
 - ✓ Assessment of the adaptability of a high-speed processing method for MCCI fuel debris.
 - ✓ Assessment of dust collection technology for chips and fragments generated by the chisel method.
 - ✓ Investigation of the characteristics of processing liquid waste that contains chips and fragments generated by the chisel method.
- Issues to be solved
 - The target duration of the fuel debris retrieval project is 10 years, and fuel debris of 300 kg must be processed daily per unit to achieve this target. However, existing processing methods cannot achieve this goal.
 - Therefore, the applicability of the chisel method which enables high-speed processing needs to be examined.
- Approaches to development
 - Evaluation items of FY2015 to FY2016
 - ✓ Phase 1: applicability evaluation through desk study
 - ✓ Phase 2: implementation of preliminary tests
 - Evaluation items of this project
 - ✓ Phase 3: development of plan for conceptual study and element tests
 - ✓ Phase 4: production of prototype units for testing and implementation of element tests

6. Implementation details of this project

6.2. Implementation details

1) Development of Technology for Prevention of Fuel Debris Spreading

(2) Development of Fuel Debris Cutting / Dust Collection System

b. Processing element tests with fuel debris simulant by effective processing methods

(i) Processing element test with chisels

● Expected outcomes

➤ Feasibility of basic processing methods applicable to MCCI fuel debris.

- Study of throughput.

==> Calculate the processing speed (XX kg/h) and study the throughput.

- Result of particle size distribution of test piece after MCCI fuel debris processing.

==> Give feedback to the team studying the method of collecting MCCI fuel debris processed pieces.

==> Measure the rate of transition to the water and input the data to the the liquid phase system specification.

- Issues concerning MCCI fuel debris processing.

==> Verify and evaluate the applicability of chisels as tools for processing MCCI fuel debris.

6. Implementation details of this project

6.2. Implementation details

1) Development of Technology for Prevention of Fuel Debris Spreading

(2) Development of Fuel Debris Cutting / Dust Collection System

b. Processing element tests with fuel debris simulants by effective processing methods

(i) Processing element test with chisels

Since relevant analysis results suggest that the chisel processing method is highly capable of handling MCCI fuel debris that constitutes most of the fuel debris, element tests on this method were performed.

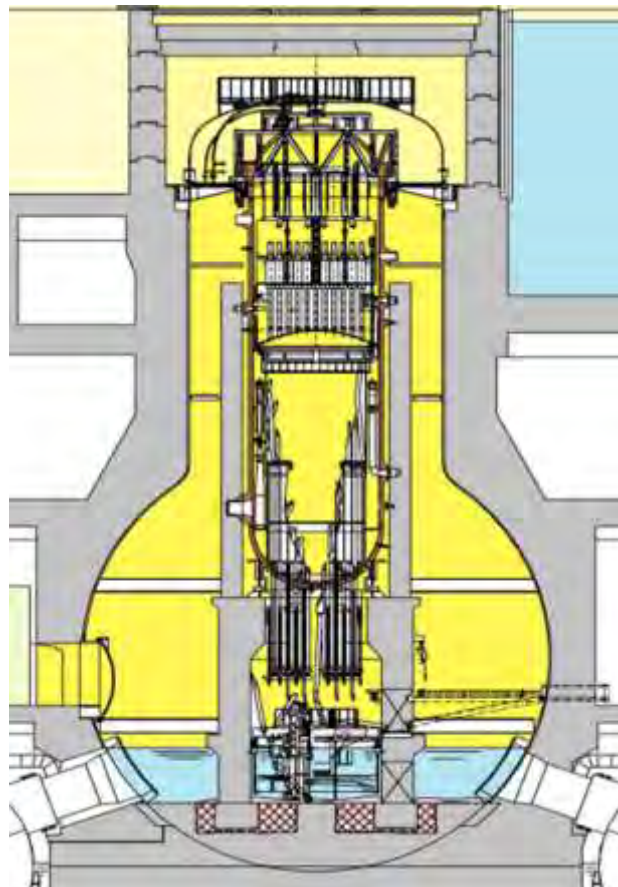

	Fuel debris Type	Major fuel debris	Features	Mass [t]	Fuel debris properties
				MAAP	Dimension
Reactor core	Fuel rod stubs (unmolten fractured fuel)	All fuel assemblies may have melted down, but some may remain	Some fuel assemblies remain without melting down	0 to 3	up to 4 m
	Powdery/grained	Adhered to or stacked on residual structures	Molten core materials rapidly cooled down, turning into small pieces		Few μm to few cm
Reactor bottom	Powdery/grained	Most of the fuel debris in this area consists of crust	Molten core materials rapidly cooled down, turning into small pieces	7 to 20	Few μm to few cm
	Lumps	The crust contains Zr metals and ZrB; some parts are hard and tough	Slowly cooled down and formed lumps		Thickness Few dozen cm
	Crust (bedrock)		Molten metals and oxide fuel mixed and solidified into fuel debris		Thickness 0.1 to 1 m
CRD/ instrumentation guide tube	Structure and adhered fuel debris	Fuel debris adhered in gaps inside and on the outer surface of tubes	Fuel debris clogged the flow passage in the lower SUS piping from the bottom end of the RPV		Penetration depth Ten-plus cm
Inside the pedestal	MCCI/powdery or grained	The fuel debris forms multiple layers; most are likely to consist of MCCI debris in lump form Large amounts of highly porous and brittle fuel debris is present	Molten reactor core materials leaked out of the RPV, dispersed, quenched, and solidified; crust fractured during MCCI and broke into small pieces due to ejection of molten corium		50 μm to 20 cm
	MCCI Crust		Ejected materials containing metal components adhered to the wall surface. Fuel debris on the floor has a hollow structure, and the upper part of the crust is porous and has less metal components.	120 to 209	Thickness: 0.1 to 1 m
	MCCI debris in lump form		Upper part of the fuel debris consists of rigid corium and is highly porous Lower part is rigid with low porosity Metallic balls are in the central area and near the wall		A few dozen cm or more
	Metal layer		Distributed relatively evenly at the bottom of MCCI debris		Under study
Outside the pedestal	MCCI/powdery or grained	Layer separation is not as clear as those inside the pedestal; there is a crust and lumps of MCCI debris	Grained debris has leaked from the pedestal		50 μm to 20 cm
	MCCI crust/lumps of MCCI debris		Corium leaked from the pedestal, reacted with concrete, and solidified; the debris had a slightly rich metal content	70 to 153	up to 0.5 m

6. Implementation details of this project

6.2. Implementation details

1) Development of Technology for Prevention of Fuel Debris Spreading







(2) Development of Fuel Debris Cutting / Dust Collection System

b. Processing element tests with fuel debris simulant by effective processing methods

(i) Processing element test with chisels

Chisel processing was tested on an MCCI debris simulant.

The test plan was executed for air-driven chisels based on preliminary test results.

No.	Type of chisel	Number of chisels	Processing scene, shape of chisel	Processing results	Notes
1	Electrically-driven type	1			
2	Electrically-driven type	1			
3	Air-driven type	2			

6. Implementation details of this project

6.2. Implementation details

1) Development of Technology for Prevention of Fuel Debris Spreading

(2) Development of Fuel Debris Cutting / Dust Collection System

b. Processing element tests with fuel debris simulant by effective processing methods

(i) Processing element test with chisels

Overview of the test process

Item	Purposes of tests (Test items)	Element test	Combination test	Notes
Basic function	Verification of processing performance by chisel alone (processing pitch, time, procedure, whether it can chip down to a specific size, etc.)	○*	—	- Process the test piece while submerged in water. - Collect the test piece after it is processed and check the particle size distribution.
	Study of and test on structure of crushing jig that uses chisels	○	—	
	Verification of the ability to install the crushing jig (at the bottom of the inside of the pedestal) and the series of steps in processing the fuel debris	—	○	
	Applicability to the MCCI fuel debris layer (whether it can be used for fuel debris with nonuniform properties)	○	○	
Test piece	Granite (This was chosen as a test piece as it is easily accessible and simulates the hardness of the MCCI fuel debris layer.)	○	○	
	MCCI simulant	○	○	

*Preliminary test will be conducted.

6. Implementation details of this project

6.2. Implementation details

1) Development of Technology for Prevention of Fuel Debris Spreading

(2) Development of Fuel Debris Cutting / Dust Collection System

b. Processing element tests with fuel debris simulant by effective processing methods

(i) Processing element test with chisels

Overview of the test process (overview of the test method)

- Preliminary test (granite):** Study the steps of processing using granite and check the test conditions (pitch of chisel processing, processing time, etc.).
- Element test (MCCI stimulant):** Verify whether the test piece (granite, MCCI simulant) can be crushed using the manufactured crushing jig.
- Combination test:** Verify the series of steps. Install the crushing jig inside the pedestal at the bottom, crush the MCCI simulant with the jig (chisel), and collect the pieces with a clamshell bucket.

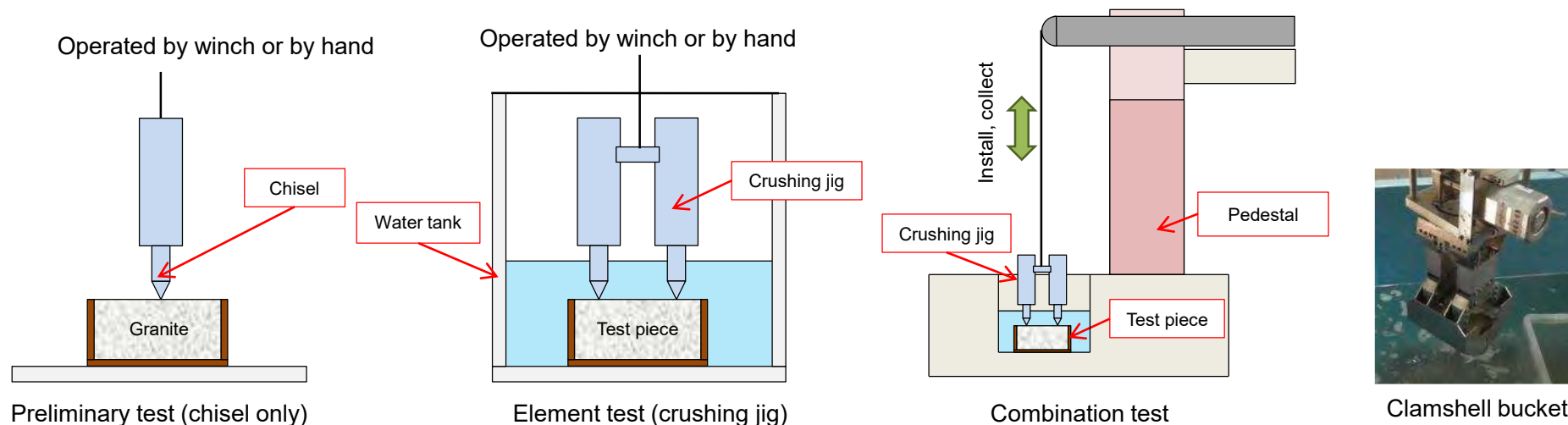

6. Implementation details of this project

6.2. Implementation details

1) Development of Technology for Prevention of Fuel Debris Spreading

(2) Development of Fuel Debris Cutting / Dust Collection System

b. Processing element tests with fuel debris simulat by effective processing methods

(i) Processing element test with chisels

Overview of the test process (test items)

Test items of processing element test with chisels

No.	Test name	Test piece	Equipment	Test environment	Confirmation items			Notes
					Particle size distribution	Processing speed	Others	
1	Preliminary tests	Granite	Chisel only	In air/under water	—	—	Processing procedure	Check chisel processing pitch and time
2		Granite	Crushing jig	Under water	—	○		
3	Element test	MCCI simulat	Crushing jig	In air/under water	○	○	Throughput	
4	Combination test	MCCI simulat	Crushing jig	Under water	—	○	Total work hours (for reference)	

Chisel specification

No.	Item	Specifications
1	Total length	480[mm]
2	Weight	8.3[kg]
3	Type of chisel	Air-driven unit
4	Number of hits	1250 [bpm]

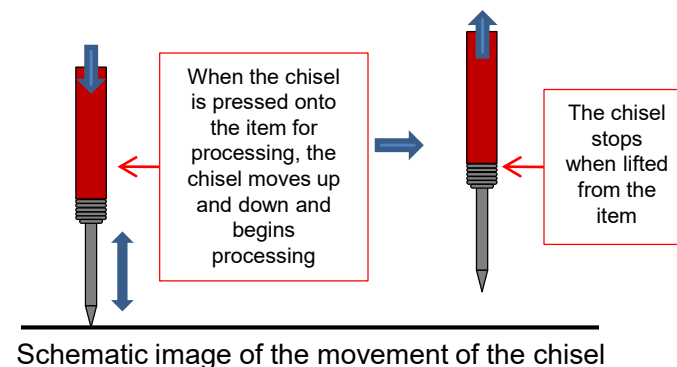
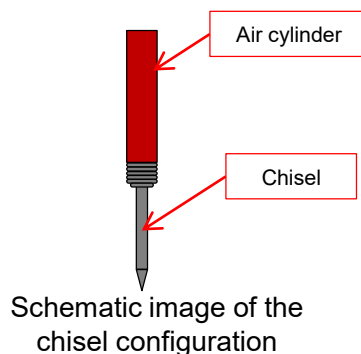

6. Implementation details of this project

6.2. Implementation details

1) Development of Technology for Prevention of Fuel Debris Spreading

(2) Development of Fuel Debris Cutting / Dust Collection System

b. Processing element tests with fuel debris simulant by effective processing methods

(i) Processing element test with chisels

a) Conditions of the preliminary test (chisel only)

- Confirm the processing procedure when the chisel is used alone (pitch of chisel processing, processing time, etc.).
- First, operate the chisel manually and process the test piece. Then, using the test results as reference, study the configuration of the crushing jig that uses a chisel.

No.	Test conditions		Grounds for the conditions
1	Test piece	Granite	Granite was chosen as a test piece as it is easily accessible, harder than concrete, and simulates the hardness of the MCCI fuel debris layer.
2	Dimension after processing (target)	50 mm cubes	This is a size that makes it easier to collect the pieces after they are processed and fits in a unit can with an internal diameter of 200 mm.

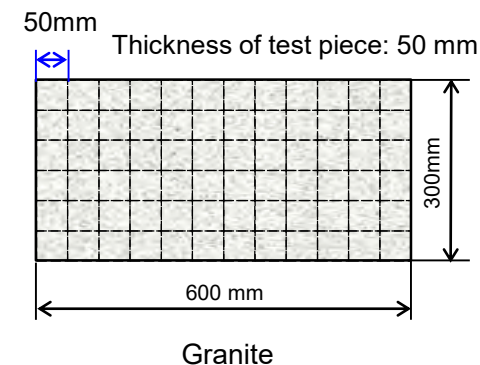
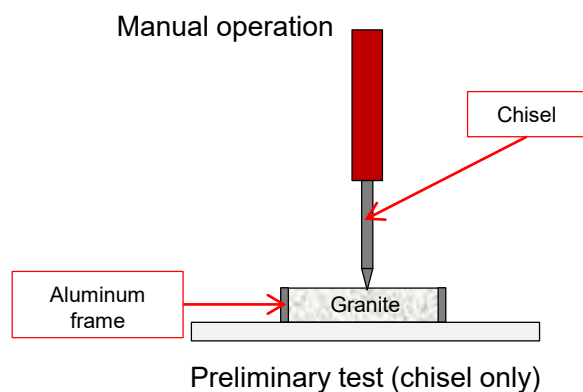

6. Implementation details of this project

6.2. Implementation details

1) Development of Technology for Prevention of Fuel Debris Spreading

(2) Development of Fuel Debris Cutting / Dust Collection System

b. Processing element tests with fuel debris simulant by effective processing methods

(i) Processing element test with chisels

a) Results of the preliminary test (chisel only)

No.	Test results	Crushing jig specifications
1	Processing the test piece in order from one side to the other makes positioning easier and can reduce the time required.	The test piece is processed from one end in a 50 mm pitch.
2	The chisel can crush the granite in five seconds per spot	The time required for processing is five seconds per spot.
3	A load of approx. 30 kg is required to suppress the reaction force produced when processing with a chisel	Taking into consideration the handling and the allowable weight of the device used in the tasks carried out in the pedestal, two chisels are used so that the weight of the crushing jig is 100 kg or lighter. ((one chisel 8.3 kg + reaction force suppressor 30 kg)*2 + device frame = approx. 100 kg)

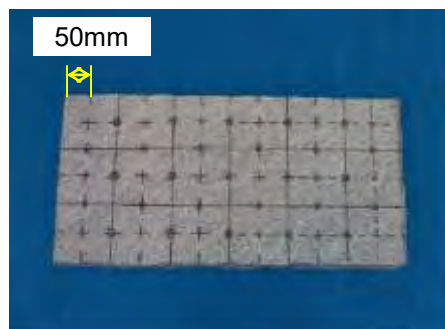

Granite before it is crushed

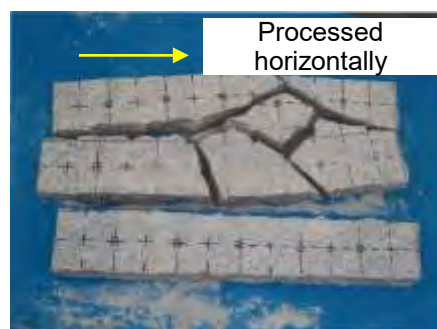

Granite while being crushed



Granite after crushed
(cubes of 50 mm or smaller)

6. Implementation details of this project

6.2. Implementation details

1) Development of Technology for Prevention of Fuel Debris Spreading

(2) Development of Fuel Debris Cutting / Dust Collection System

b. Processing element tests with fuel debris simulants by effective processing methods

(i) Processing element test with chisels

b) Conditions of the preliminary test (crushing jig) (test on underwater granite processing)

A processing test is conducted on granite in water under the test conditions shown on the right table. These conditions were determined based on the results of the sampling test. A chisel will use the weight of the jig to process the granite. The processing time will be measured during the test. However, this includes time required to lift and lower the crushing jig with a chain block, position the chisel, and lift and lower the chisel with a hydraulic cylinder.

No.	Items	Specifications
1	Test piece	Granite (300 × 600 × 50 mm)
2	Water level	300 mm above the top surface of the granite
3	Processing procedure	Processed in 50 mm pitch from one side (entire granite is processed) Check the mark on the top part of the device and begin processing without looking at the test piece
4	Processing time	Five seconds per spot
5	Crushing depth	30 [mm] from the top surface of the granite
6	Measurement items	Processing time, weight, and speed, as well as particle size distribution

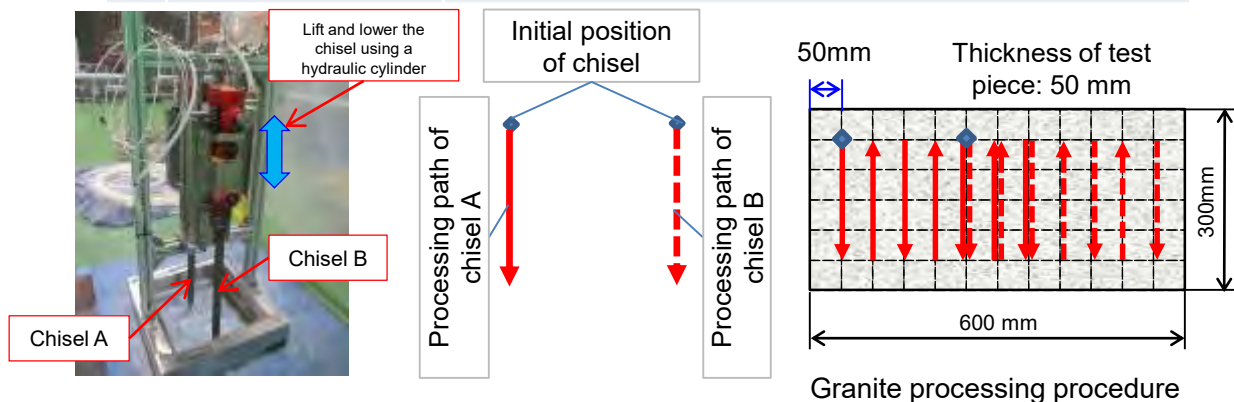
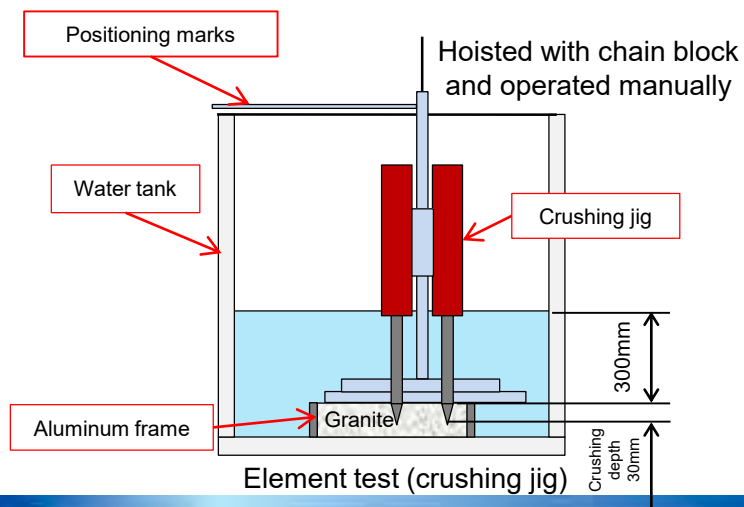

6. Implementation details of this project

6.2. Implementation details

1) Development of Technology for Prevention of Fuel Debris Spreading

(2) Development of Fuel Debris Cutting / Dust Collection System

b. Processing element tests with fuel debris simulant by effective processing methods

(i) Processing element test with chisels

b) Results of the preliminary test (crushing jig) (test on underwater granite processing)

- The water became cloudy right after processing began, but workers were able to proceed by following the marks indicating the positions placed on the top part of the device.
- It took 17 minutes 35 seconds to process a 22.3 kg granite, which means that the processing speed was 76.2 kg/h.
- It was confirmed that the particle size distribution of the granite after it was crushed were all the sizes that can be collected in a unit can (φ200 mm or smaller).

--> The granite was processed to a size that can be collected in a unit can. The conclusion was reached that processing went as planned, decisions have been made to conduct processing tests on MCCI debris simulants with the same processing conditions as this.

Measurement results of particle size distribution

Classification [mm]	Weight [g]	Ratio [%]
up to 0.1	50.45	0.23
0.1 to 1	316.17	1.42
1 to 5	480.11	2.15
5 to 10	406.1	1.82
10 to 50 cubes	2769.77	12.40
50 to 70 cubes	2541.82	11.38
70 to 100 cubes	7598.87	34.03
100 cubes to φ200	8167.67	36.58
Processed weight [kg]	22.3	
Processing time [min]	17.6	
Processing speed [kg/h]	76.2	

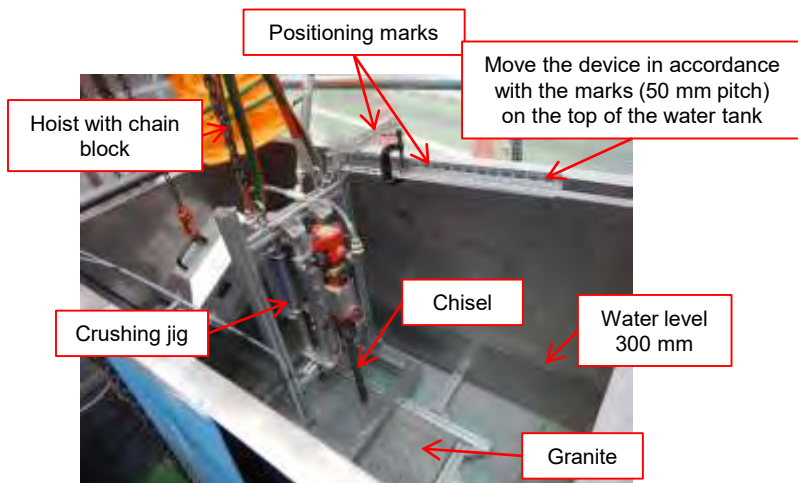

6. Implementation details of this project

6.2. Implementation details

1) Development of Technology for Prevention of Fuel Debris Spreading

(2) Development of Fuel Debris Cutting / Dust Collection System

b. Processing element tests with fuel debris simulant by effective processing methods

(i) Processing element test with chisels

c) Conditions of element tests (processing test on MCCI debris simulants out the water)

A processing test on MCCI debris simulants were conducted out the water before conducting it under water.

The processing time will be measured during the test. However, this includes time required to lift and lower the crushing jig with a chain block, position the chisel, and lift and lower the chisel with a hydraulic cylinder.

No.	Items	Specifications
1	Test piece	MCCI simulant ($\phi 560 \times 300$ mm)*
2	Water level	In air
3	Processing procedure	Processed in 50 mm pitch from one side (processed area: 300 x 350 mm) Check the mark on the top part of the device and begin processing without looking at the test piece
4	Processing time	Five seconds per spot
5	Crushing depth	30 [mm] from the top surface of the MCCI stimulant
6	Measurement items	Processing time, weight, and speed, as well as particle size distribution

*Refer to slides No. 103 to 104 regarding manufacturing of MCCI stimulant.

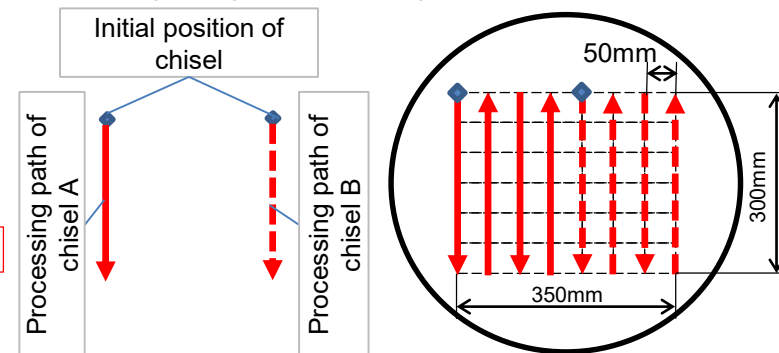
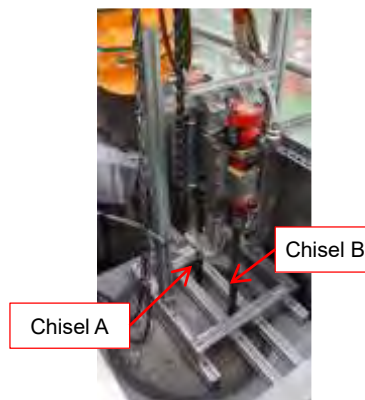
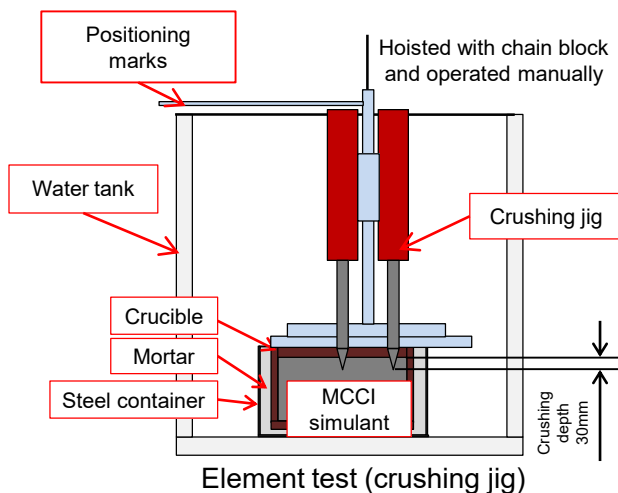

MCCI simulant processing procedure

6. Implementation details of this project

6.2. Implementation details

1) Development of Technology for Prevention of Fuel Debris Spreading

(2) Development of Fuel Debris Cutting / Dust Collection System

b. Processing element tests with fuel debris simulant by effective processing methods

(i) Processing element test with chisels

c) Results of element tests (processing test on MCCI debris simulants in the air)

- It was confirmed that MCCI debris simulants can be processed with a chisel.
- It took 10 minutes 49 seconds to process a 6.53 kg simulant (total weight of the pieces), which means that the processing speed was 36.2 kg/h.
- The particle size distribution of the pieces after the simulant was crushed were all 100 mm cubes or smaller.
- For every spot, it took approx. 20 seconds to position the chisel and 5 seconds to process the simulant.

Measurement results of particle size distribution

Classification [mm]	Weight [g]	Ratio [%]
up to 0.1	37.71	0.58
0.1 to 1	137.2	2.10
1 to 5	512.28	7.84
5 to 10	735.79	11.26
10 to 50	3814.19	58.38
50 to 70	938.92	14.37
70 to 100	357.52	5.47
100 or larger	0	0.00
Processed weight [kg]	6.53	
Processing time [min]	10.8	
Processing speed [kg/h]	36.2	



MCCI simulant before processing



MCCI simulant after processing

6. Implementation details of this project

6.2. Implementation details

1) Development of Technology for Prevention of Fuel Debris Spreading

(2) Development of Fuel Debris Cutting / Dust Collection System

b. Processing element tests with fuel debris simulant by effective processing methods

(i) Processing element test with chisels

c) Results of element tests (processing test on MCCI debris simulants in the air)

- Broken pieces were collected from the processed simulant and in most areas, the simulant was processed to a depth of approx. 30 mm.
- After crushing the simulant, the broken pieces were observed; some were porous (brown pieces) while others were not (grey pieces).
- Area where the top surface of the simulant was humped was not crushed. The chisel may not have been able to crush it as the hump created a slope and the surface was not perpendicular to the chisel.



The brown spots are believed to be porous bottom which was exposed by crushing the porous parts of the simulant

Area where the top surface was humped

MCCI simulant after broken pieces were removed



Porous piece



Few-porous piece

6. Implementation details of this project

6.2. Implementation details

1) Development of Technology for Prevention of Fuel Debris Spreading

(2) Development of Fuel Debris Cutting / Dust Collection System

b. Processing element tests with fuel debris simulant by effective processing methods

(i) Processing element test with chisels

c) Conditions of element tests (processing test on MCCI debris simulants under water)

MCCI simulant processing test was conducted under water.

The processing time will be measured during the test. However, this includes time required to lift and lower the crushing jig with a chain block, position the chisel, and lift and lower the chisel with a hydraulic cylinder.

No.	Item	Specifications
1	Test piece	MCCI simulant (φ560 × 300 mm)
2	Water level	300 mm above the top surface of the MCCI stimulant
3	Processing procedure	Processed in 50 mm pitch from one side (processed area: 300 × 350 mm) Check the mark on the top part of the device and begin processing without looking at the test piece
4	Processing time	Five seconds per spot
5	Crushing depth	30 [mm] from the top surface of the MCCI stimulant
6	Measurement items	Processing time, weight, and speed, as well as particle size distribution

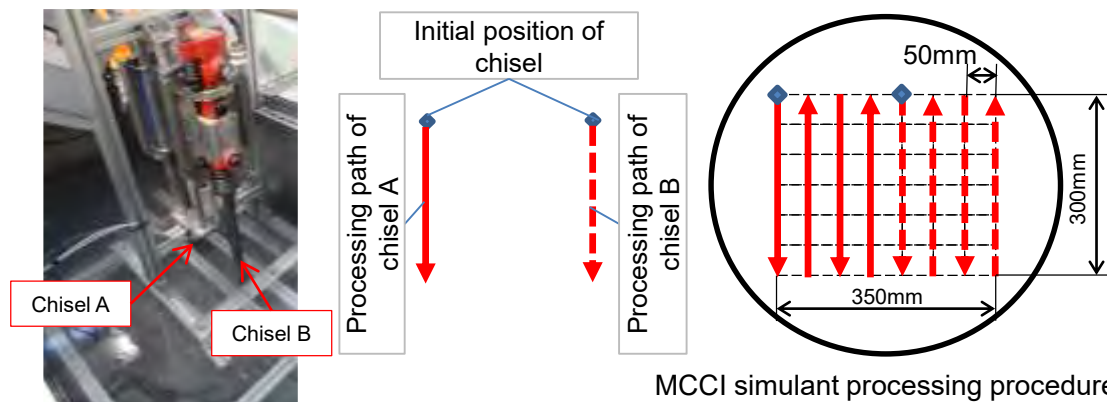
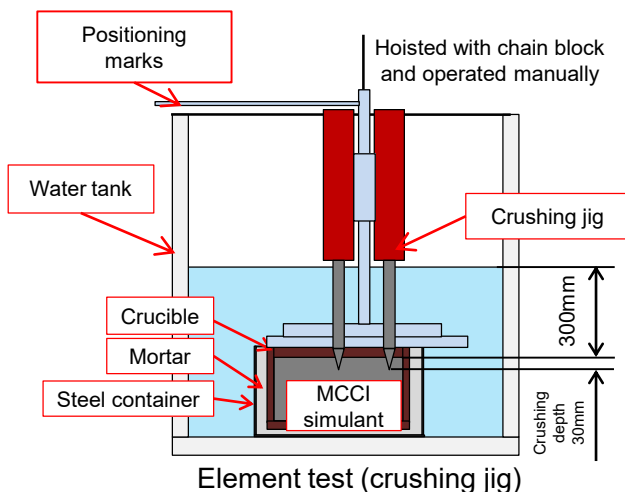

6. Implementation details of this project

6.2. Implementation details

1) Development of Technology for Prevention of Fuel Debris Spreading

(2) Development of Fuel Debris Cutting / Dust Collection System

b. Processing element tests with fuel debris simulants by effective processing methods

(i) Processing element test with chisels

c) Results of element tests (processing test on MCCI debris simulants under water)

- The water became cloudy right after processing began, but workers were able to proceed by following the marks indicating the positions placed on the top part of the device.
- Broken pieces were collected from the processed simulant and it was confirmed that some areas were not crushed.
- It took 11 minutes 5 seconds to process a 6.78 kg simulant (total weight of the pieces), which means that the processing speed was 36.7 kg/h.
- The particle size distribution of the pieces after the simulant was crushed were all 70 mm cubes or smaller.
- During the process, there were several times when the chisel got stuck in the MCCI simulant and would not come out by lifting the blade. It had to be removed by pulling it up by hand.
- Although some parts were not crushed, a similar amount of the test piece was processed compared with the test conducted out of the water, which likely means that the processed layer had a large specific gravity.

Measurement results of particle size distribution

Classification [mm]	Weight [g]	Ratio [%]
up to 0.1	15.26	0.22
0.1 to 1	96.13	1.42
1 to 5	477.39	7.03
5 to 10	835.44	12.30
10 to 50	4116.43	60.62
50 to 70	1250.37	18.41
70 to 100	0	0.00
100 or larger	0	0.00
Processed weight [kg]	6.79	
Processing time [min]	11.1	
Processing speed [kg/h]	36.7	



MCCI simulant before processing



MCCI simulant after processing

6. Implementation details of this project

6.2. Implementation details

1) Development of Technology for Prevention of Fuel Debris Spreading

(2) Development of Fuel Debris Cutting / Dust Collection System

b. Processing element tests with fuel debris simulant by effective processing methods

(i) Processing element test with chisels

c) Results of element tests (processing test on MCCI debris simulants under water)

- Broken pieces were collected from the processed simulant and it was confirmed that some areas were not crushed.
- Parts that were not crushed were processed once again out the water with a chisel. This created small pieces.
- Parts of the MCCI simulant where the surfaces remained and were not crushed had cracks and holes. This suggests that the chisel was able to process the simulant but because cracks did not develop the simulant was not crushed into pieces that could be collected.

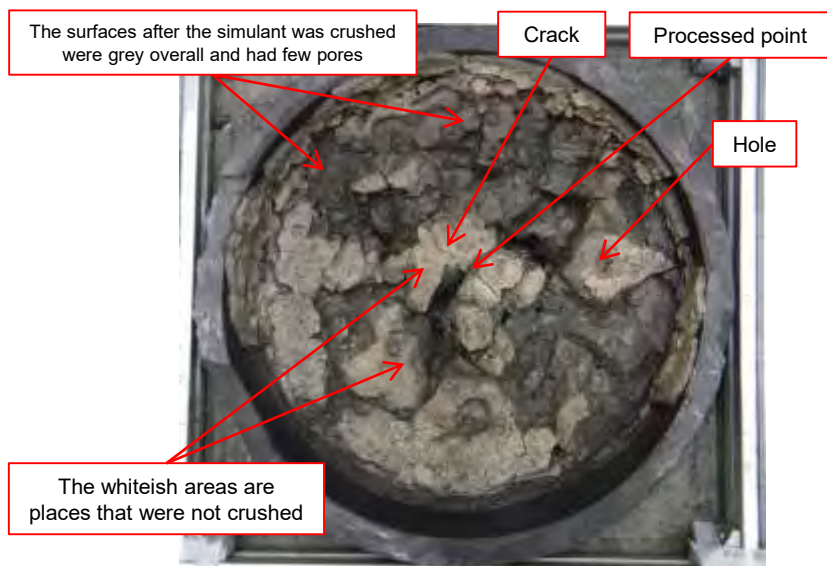

MCCI simulant after broken pieces were removed



Broken pieces collected after first processing



Broken pieces collected after additional processing

6. Implementation details of this project

6.2. Implementation details

1) Development of Technology for Prevention of Fuel Debris Spreading

(2) Development of Fuel Debris Cutting / Dust Collection System

b. Processing element tests with fuel debris simulant by effective processing methods

(i) Processing element test with chisels

c) Test conditions of combination test

The procedure, from the installation of the crushing jig on the bottom of the pedestal (inside), to processing and collection of fuel debris was verified.

Crushing jig which processes fuel debris and a tool for collecting crushed MCCI debris simulants are separate tools and shall be replaced manually. Operation time of other methods which uses remote control device will be confirmed.

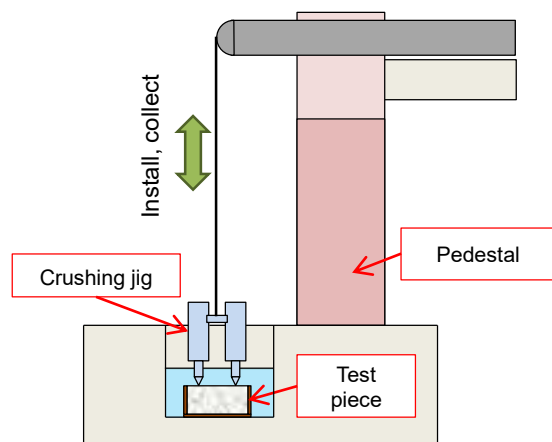

Schematic illustration of combination test

No.	Items	Specifications
1	Test piece	MCCI simulant ($\phi 560 \times 300$ mm)
2	Water level	300 mm above the top surface of the MCCI simulant
3	Processing procedure	Processed from one end in 50 mm pitch (target); positioning adjusted by remote control device
4	Processing time	Five seconds per spot
5	Crushing depth	30 [mm] from the top surface of the MCCI simulant (restriction due to device structure)
6	Measurement items	Crushing jig installation time MCCI debris simulant processing time MCCI debris simulant pieces collection time (collection speed: XX kg/h)

6. Implementation details of this project

6.2. Implementation details

1) Development of Technology for Prevention of Fuel Debris Spreading

(2) Development of Fuel Debris Cutting / Dust Collection System

b. Processing element tests with fuel debris simulant by effective processing methods

(i) Processing element test with chisels

d) Test results of combination test

The test results are summarized in the table below.

No.	Measurement items	Test results
1	Time required to install crushing device inside the pedestal	Installation time per device: 150 min.
2	MCCI debris simulant processing time	Positioning and processing per spot: 5 min. (three spots in the test)
3	Time required to uninstall the crushing device and take it out of the pedestal	Uninstallation time per device: 40 min.
4	Time required to install a clamshell bucket inside the pedestal	Installation time per clamshell bucket: 65 min. (unit can is attached to the clamshell bucket manually)
5	Collection of broken pieces using a clamshell bucket	Positioning and collection per spot: 4 min. (one spot in the test) Sand-like pieces are collected.
6	Storage of collected pieces in a unit can	Storage time per spot: 15 min. (unit can is positioned manually)

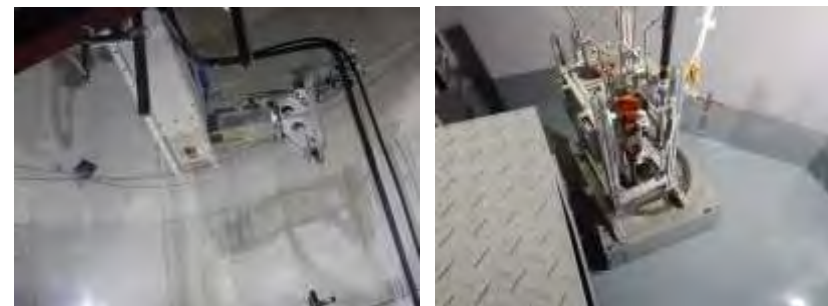

Operation of device in the combination test



MCCI simulant after processing

6. Implementation details of this project

6.2. Implementation details

1) Development of Technology for Prevention of Fuel Debris Spreading

(2) Development of Fuel Debris Cutting / Dust Collection System

b. Processing element tests with fuel debris simulant by effective processing methods

(i) Processing element test with chisels

Future issues and action policy

*Contents of the action policy will be worked on through future engineering activities.

No.	Issues	Action policy*
1	Some parts of the MCCI simulant were easier to crush than others, and there were areas where the simulant could not be processed.	Appropriate processing methods such as the pitch in which the chisel processes need to be studied.
2	A large portion of the processing time was used to position the crushing jig.	By reducing the time required to do this, the processing speed can likely be increased.
3	The processing time of the chisel method was measured, but the series of steps including the replacement of the tool by remote control couldn't be measured.	Assembly of the device by remote control and replacement of tip tool (chisel to fuel debris retrieval device) will be verified with tests.

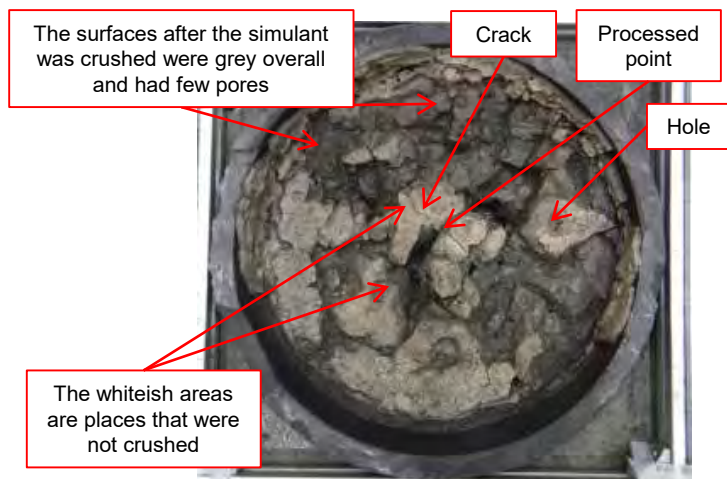

Processed MCCI debris simulant after processing and removal of broken pieces

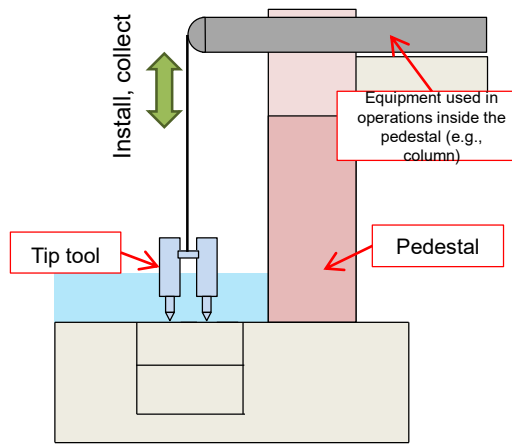

Schematic illustration of task performed inside the pedestal



Crushing jig (chisel)



Clamshell bucket

Example of tip tools

6. Implementation details of this project

6.2. Implementation details

1) Development of Technology for Prevention of Fuel Debris Spreading

(2) Development of Fuel Debris Cutting / Dust Collection System

b. Processing element tests with fuel debris simulant by effective processing methods

(ii) Processing element tests with ultrasonic core boring

- Development objectives:
 - To develop a processing method with less reaction force and less dust diffusion.
 - To realize a processing method that can be used for metals, ceramics, concrete, and composite materials.
- Final target of development

Item	Criteria and targets	Notes
	Element tests, prototype tests	
Processing speed	30 [kg/hr] or faster	300 [kg/day] is targeted
Weight	50[kg]	Manipulator capacity is taken into account
Boring diameter	Seeking to achieve 75 [mm] or larger	This test corresponds to the core boring test (66 [mm]) conducted in the previous fiscal year
Water volume	0.004 [m ³] is targeted	Collection ability is taken into account
Others	Collect and analyze chips and crumbs that are 0.1 [μm] or larger	Results are reflected in the chip and crumb collection system

6. Implementation details of this project

No.94

6.2. Implementation details

1) Development of Technology for Prevention of Fuel Debris Spreading

(2) Development of Fuel Debris Cutting / Dust Collection System

b. Processing element tests with fuel debris simulant by effective processing methods

(ii) Processing element tests with ultrasonic core boring

- Issues to be resolved: Verification of the processing method's applicability to fuel debris retrieval
 - Diversification of processed materials
 - The processed materials are metals (ductile material) with oxides (crustaceous material) present in random areas.
 - If oxides are deposited in metal, the material becomes extremely hard in some parts.
 - Bits and conditions of ultrasonic waves are generally changed according to the property of the target material. The applicability of this method to fuel debris in the 1st floor is unknown due to the variance in its properties and condition.
 - Enhancement of processing speed
 - The size of the bit used with existing technology is approx. $\phi 3$ mm. Processing speed may be enhanced by using core bits of larger size, etc.
 - Particle size distribution of secondary products in liquid waste produced during processing
- Expected outcome
 - Study of the throughput based on the processing conditions and performance (processing speed)
 - Study of applicable area including sampling and the scale of retrieval (small-amount / large – amount)
 - Dust diameter distribution

6. Implementation details of this project

No.95

6.2. Implementation details

1) Development of Technology for Prevention of Fuel Debris Spreading

(2) Development of Fuel Debris Cutting / Dust Collection System

b. Processing element tests with fuel debris simulant by effective processing methods

(ii) Processing element tests with ultrasonic core boring

Overview and procedures of development

- Desktop design

Design a larger core bit (existing bit: $\phi 3$ mm, final target $\phi 75$ mm) that is not available in the existing technology

Develop a $\phi 38$ mm (1.5 inch) head and evaluate the feasibility of a $\phi 75$ mm bit by conducting a performance test

Ultrasonic transducer (piezoelectric actuator)

Number of rows, placement, power supply

Design of amplifier (increase in amplitude, prevention of side-to-side runout)

Optimization by conducting vibration simulation using finite element method (evaluation of amplitude at processed point)

Rotary mechanism (high-speed motor)

Support mechanism (enhancement of rigidity, resonant frequency)

- Element test (using existing building machine)

Understand the processing ability of different bits

Evaluate processing characteristics (processing speed, reaction force, chips and crumbs, etc.)

Observe the applicability to fuel debris retrieval

6. Implementation details of this project

6.2. Implementation details

1) Development of Technology for Prevention of Fuel Debris Spreading

(2) Development of Fuel Debris Cutting / Dust Collection System

b. Processing element tests with fuel debris simulat by effective processing methods

(ii) Processing element tests with ultrasonic core boring

- Development of a processing head by desktop design

Design a larger processing head (existing bit: $\phi 3$ mm, final target $\phi 75$ mm) that is not available in the existing technology

Develop a $\phi 38$ mm (1.5 inch) head and evaluate the feasibility of a $\phi 75$ mm bit by conducting a performance test

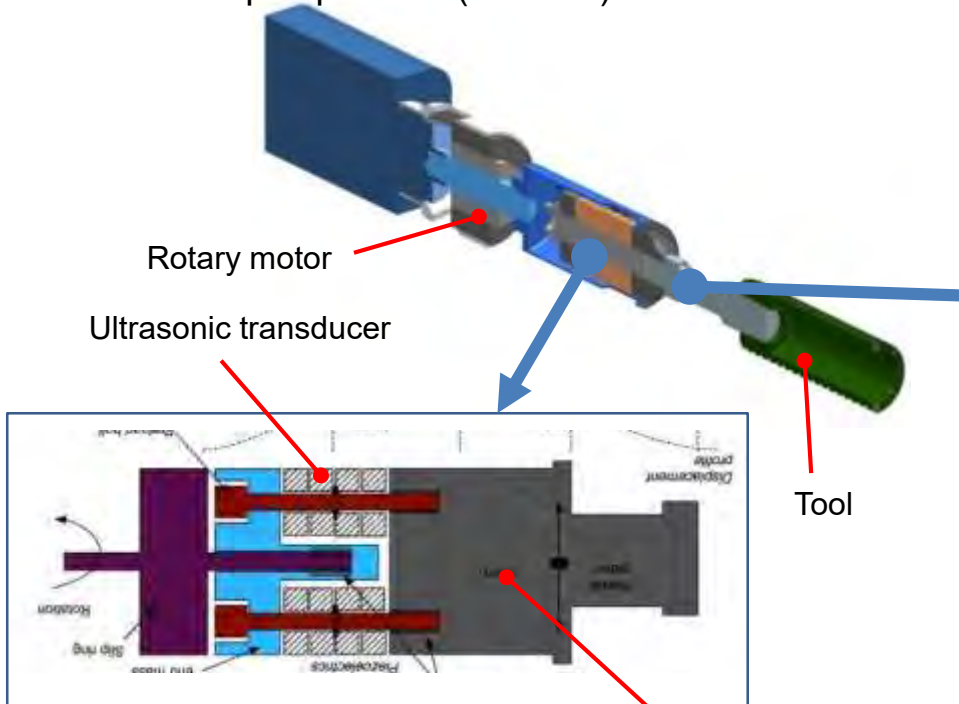

High-power transducer using the multilayer structure (multi piezoelectric elements) of an ultrasonic transducer was designed.

Vibration amplifier

Vibration amplifier: the tip of the tool (right corner in the diagram above) was analyzed and optimized so that the amplitude is maximized.

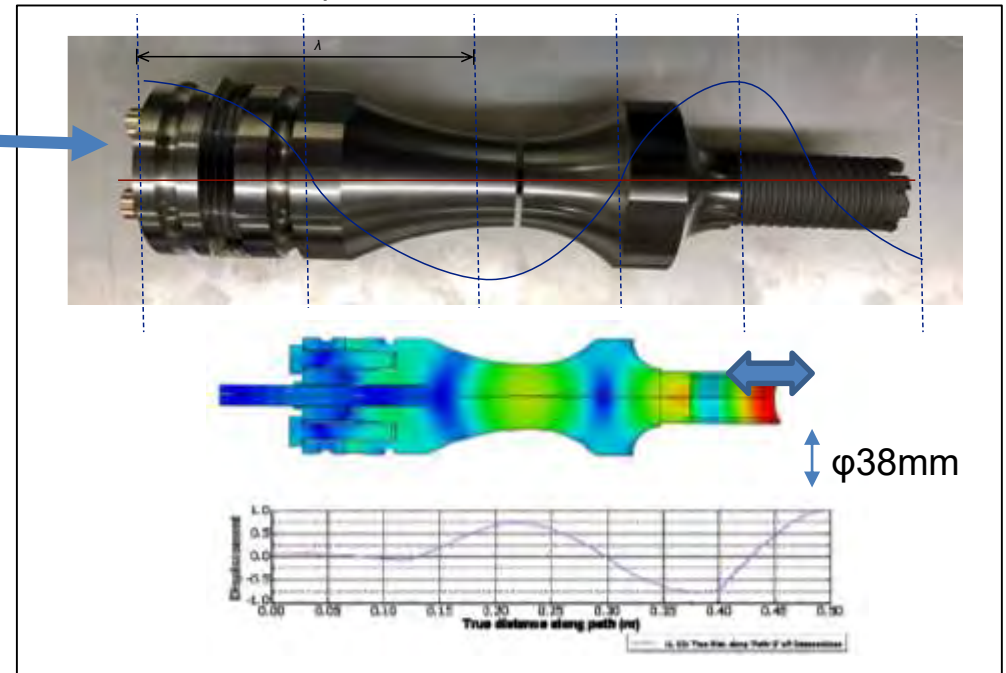

6. Implementation details of this project

No.97

6.2. Implementation details

1) Development of Technology for Prevention of Fuel Debris Spreading

(2) Development of Fuel Debris Cutting / Dust Collection System

b. Processing element tests with fuel debris simulant by effective processing methods

(ii) Processing element tests with ultrasonic core boring

- External appearance of the processing test equipment

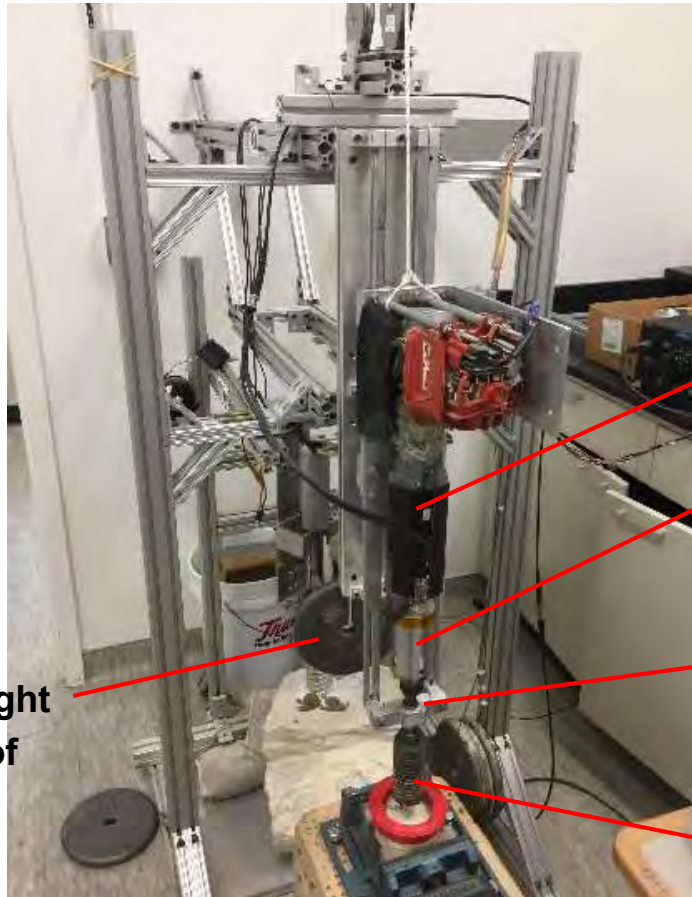

Counterweight
Addition of
preload

Rotary motor

Ultrasonic transducer

Creates a vertical ultrasonic vibration.

Vibration amplifier

Transmits and amplifies ultrasonic vibrations at the same time. No transition of vibration modes.

Tool

Blade edge that cuts the samples.

Material of test pieces

Materials	Hardness
Stainless steel (304)	1.5 to 3 GPa
Zirconia (ZrO_2)	12 to 14 GPa
Aluminum oxide (Al_2O_3)	15 to 17 GPa
Concrete	—
Stainless steel + ZrO_2 or Al_2O_3	—
Fuel debris simulant	—

6. Implementation details of this project

6.2. Implementation details

1) Development of Technology for Prevention of Fuel Debris Spreading

(2) Development of Fuel Debris Cutting / Dust Collection System

b. Processing element tests with fuel debris simulant by effective processing methods

(ii) Processing element tests with ultrasonic core boring

● Element test

- Diamond coating and electroforming tools were compared for evaluation.
- In the initial phase of the processing, the cutting speed of the diamond coating core was faster. However, as there was a significant loss of diamond abrasive grains and wear of the tool, it was not suitable for long-hour use. Study of bits needs to continue in the future.
- **The processing speed was calculated based on the driving speed of the electroforming bit. The speed was approx. 3.3 kg/h for aluminum oxides and 0.63 kg/h for stainless steel.**
- The reaction force was 1,200 N and the pressure per cross-sectional area is in the order of MPa. **Approx. 3,000 to 4,000 N of pressurization is required to bore with a $\phi 75$ mm bit (target size).** In this case, **the processing speed would be 12.7 kg/h.**



Ceramic (aluminum oxide) on left and metal (stainless steel) on right, both cut by diamond coating bits.

30 mm diamond coating core bit				
	Rotation	Rotation + ultrasonic wave	Rotation	Rotation + ultrasonic wave
	Aluminum oxide		Stainless steel	
Rotation speed (rpm)	2750	2750	2750	2750
Depth (mm)	25.4	25	0.95	1.5
Rate (mm/min)	32.1	89	0.95	1.85
Reaction force (N)	1200	1200	1200	1200
Condition of bit	Good	Good	Bad	Bad

1.5 inch diamond electroforming bit		
	Rotation	Rotation
	Aluminum oxide	Stainless steel
Rotation speed (rpm)	650	1150
Depth (mm)	33	1.5
Rate (mm/min)	6.0	1.15
Reaction force (N)	1200	1200
Condition of bit	Good	Good

6. Implementation details of this project

6.2. Implementation details

1) Development of Technology for Prevention of Fuel Debris Spreading

(2) Development of Fuel Debris Cutting / Dust Collection System

b. Processing element tests with fuel debris simulat by effective processing methods

(ii) Processing element tests with ultrasonic core boring

Ultrasonic units were selected based on differences of vertical vibration modes (amount of displacement) of amplifiers, element test using existing devices, etc.

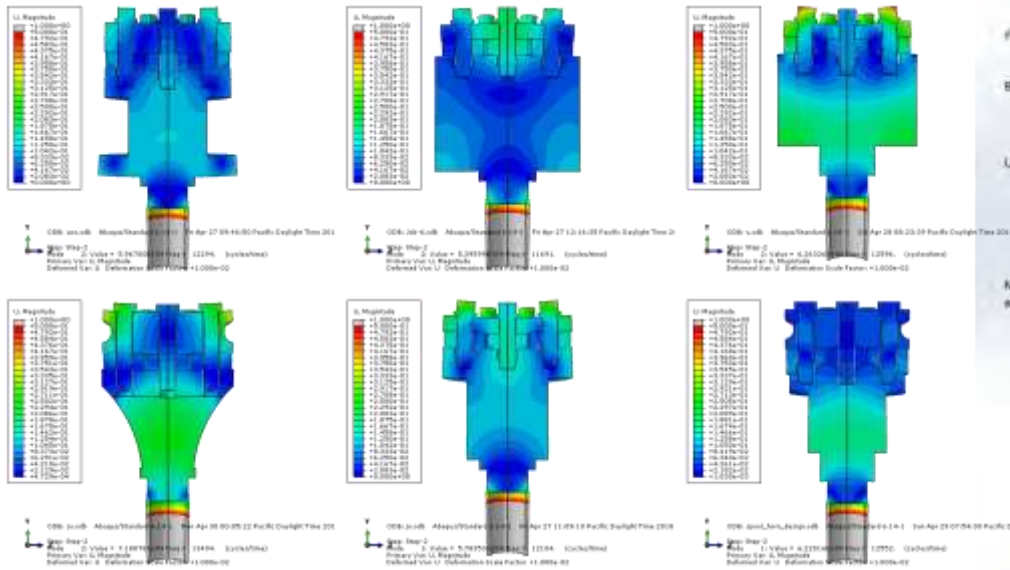

Difference in vertical vibration modes (amount of displacement) of amplifiers (example)

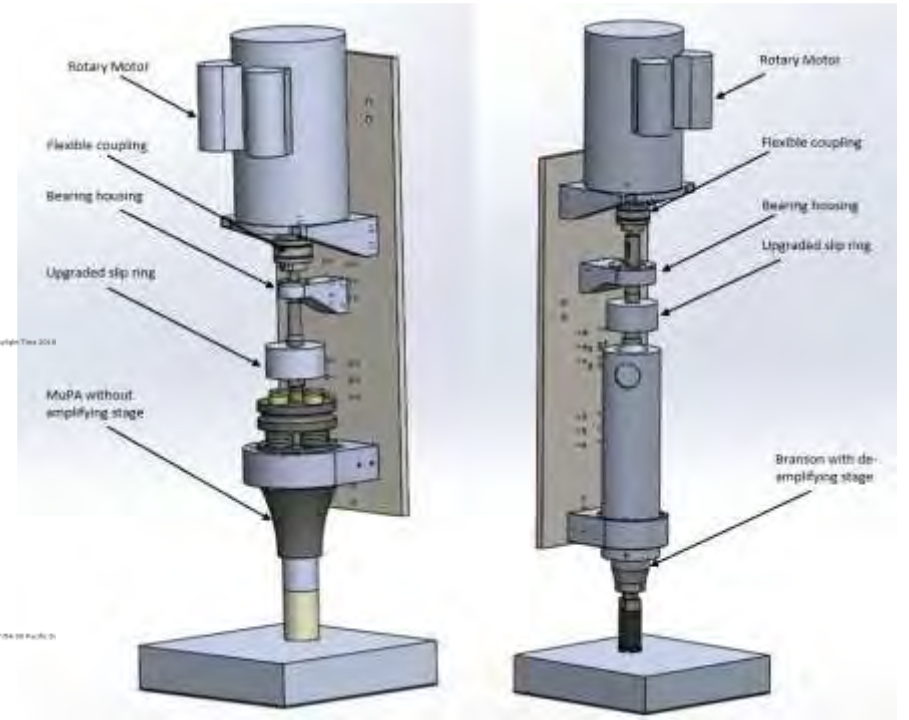

MuSPA unit

Branson unit

Design of processing devices with units were selected

6. Implementation details of this project

6.2. Implementation details

1) Development of Technology for Prevention of Fuel Debris Spreading

(2) Development of Fuel Debris Cutting / Dust Collection System

b. Processing element tests with fuel debris simulant by effective processing methods

(ii) Processing element tests with ultrasonic core boring

● Processing test on prepared MCCI debris simulants

Processing test was conducted by cutting out a sample from the center and bottom of the fuel debris simulant.

- Tool: diamond electroforming bit (φ4.5 mm)
- Rotation speed of tool: 800 rpm
- Ultrasonic vibration frequency: 50 kHz
- Tip amplitude: 5 μm
- Processing speed: 0.8 mm/min.

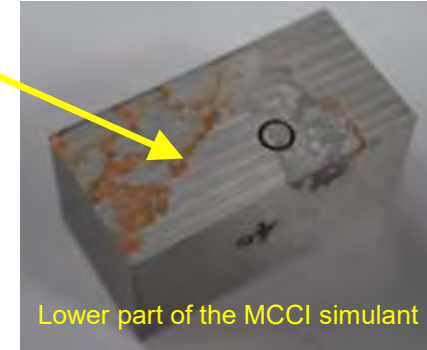
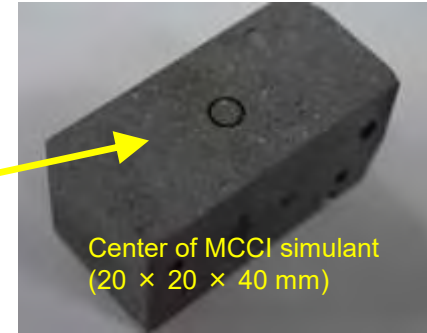

	Center	Bottom	For comparison (aluminum oxide, SUS composite material)
Condition of sample	Charcoal grey	Metallic shine Zero electrical resistance	
Reaction force	1.3MPa	3.3MPa	10.0MPa
Processing speed	0.8mm/min (removal speed: 6 g/h)	0.8mm/min (removal speed: 6 g/h)	0.4mm/min (removal speed: 3 g/h)

- The reaction force per cross-sectional area is in the order of MPa in both the center and bottom of the simulant. Compared with the processing test conducted on aluminum oxide with a φ38 mm bit (previous page) (φ38 mm), the diameter of the bit is about 1/10 the size but has almost the same order.
- The removal speed is always in the order of grams and is extremely small (as the cross-sectional area is small).
- A reaction force of 3,000 to 4,000N is required to bore materials with a larger cross-section using a φ 75mm (target size).

6. Implementation details of this project

No.101

6.2. Implementation details

1) Development of Technology for Prevention of Fuel Debris Spreading

(2) Development of Fuel Debris Cutting / Dust Collection System

b. Processing element tests with fuel debris simulant by effective processing methods

(ii) Processing element tests with ultrasonic core boring

● Outcomes of this project

- Of the four commercially available structures, Branson and MuSPA were selected.
- A conceptual study of a vibration unit that supports $\phi 75$ mm large-diameter core bit (final target size) was conducted. An analysis of vibration mode using finite element simulation along with analysis using prototype machines was conducted on a $\phi 38$ mm (1.5 inch) bit.
- Processing tests using $\phi 30$ mm and $\phi 1.5$ inch core bits were conducted. Various materials which fuel debris are expected to consist of (metal, ceramic, MCCI debris simulants, etc.) were confirmed to be processable.
- The processing speed was approx. 3.3 kg/h for aluminum oxide and 0.63 kg/h for stainless steel. The reaction force per unit cross-sectional area all requires the order of MPa. Assuming that the large bit of the target size ($\phi 75$ mm) is used, the evaluated reaction force would be 3,000 to 4,000 N and processing speed would be 12.7 kg, meaning that the speed does not reach the target value.
- Changing the material of the core bit has both advantages and disadvantages in terms of processing speed and lifetime of the bit. Further study will likely be necessary in the future.

● Future issues and action plan

	Issues	Action policy
1	Processing speed is not satisfactory for fuel debris retrieval. Enhance the speed and identify applications suitable for ultrasonic processing (e.g., sampling).	The possibility for enhancing processing speed will be identified by parameter tests, etc. Tests will be conducted in the future in the development stage.
2	Conduct a conceptual study of the device for retrieval of fuel debris using core boring (implementation of ultrasonic core boring on the retrieval device).	Conceptual study of the applicability of the device (study of the processing head and integration with retrieval device) will be conducted in the future in the development stage.
3	Study the separation and collection method of the lower end of the cut material (base of cylinder).	Study of methods and element tests will be conducted in the development stage.

6. Implementation details of this project

6.2. Implementation details

1) Development of Technology for Prevention of Fuel Debris Spreading

(2) Development of Fuel Debris Cutting / Dust Collection System

b. Processing element tests with fuel debris simulat by effective processing methods

(ii) Processing element tests with ultrasonic core boring

Concept of collection of fuel debris inside RPV by top access

Operation floor work cell
Boundary established between the cell and PCV. Cell has shielding function for short tasks carried outside the cell.

Transfer container
The container has a common design as containers for transferring samples and for taking samples from inside the PCV.

Guide pipe
PCV boundary is extended.

Device for accessing inside RPV
Device accesses vertically from the operation floor to the shroud head.

Device spread out inside RPV
Device spreads out horizontally and ascends/descends in the RPV

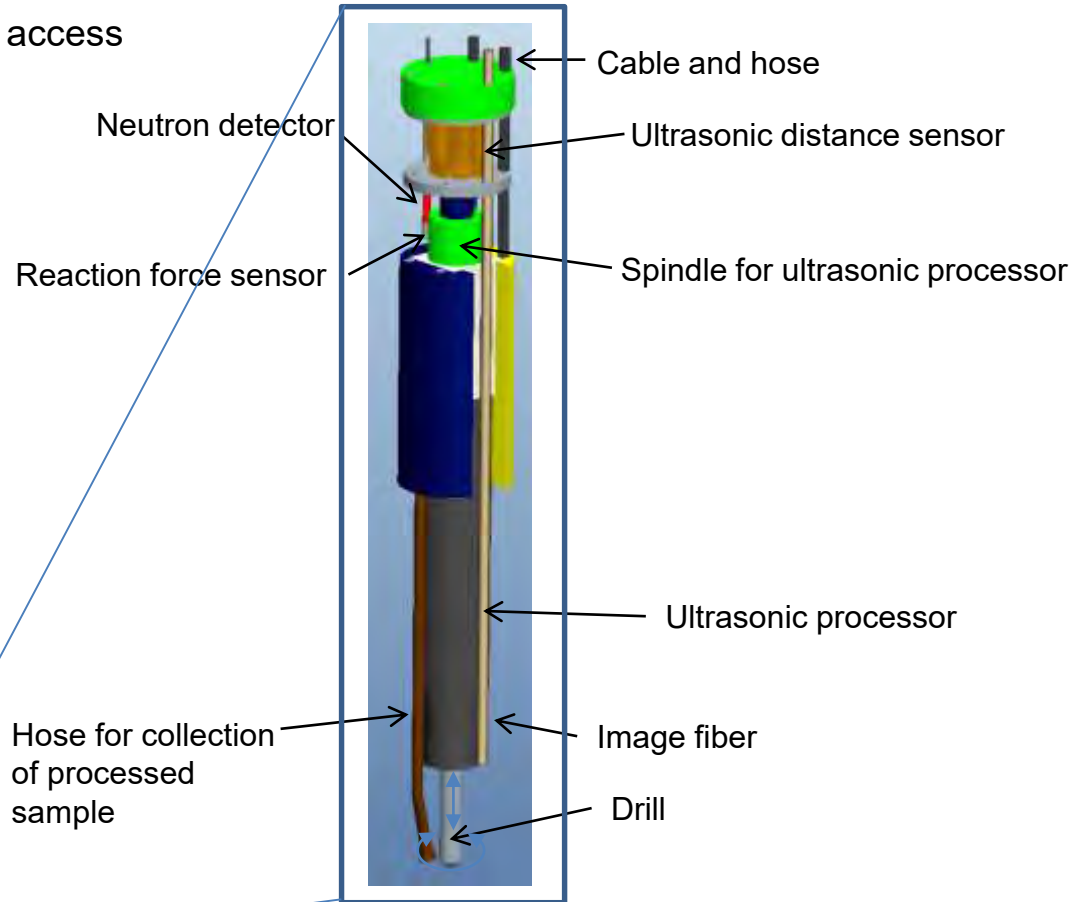
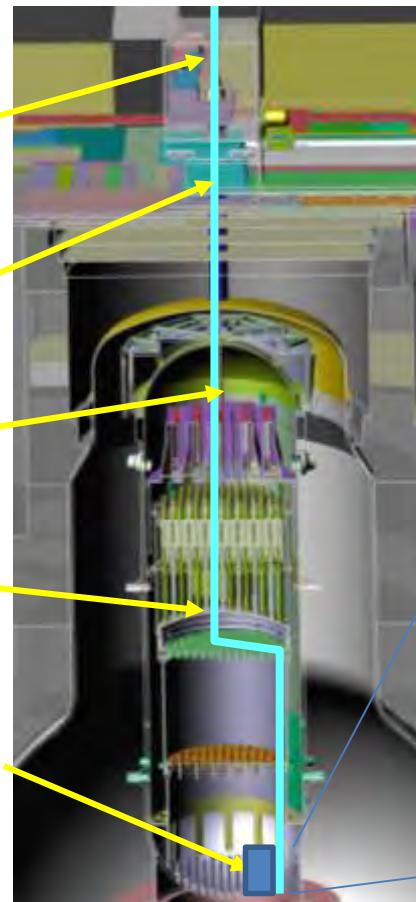

Concept of sample collection device (for collecting powder generated during processing and cylindrical fuel debris)

6. Implementation details of this project

6.2. Implementation details

1) Development of Technology for Prevention of Fuel Debris Spreading

(2) Development of Fuel Debris Cutting / Dust Collection System

c. Production of fuel debris and contaminated structure simulants for processing tests

a) MCCI simulant

Regarding the MCCI debris simulants which are planned to be used in the processing element test, the type, amount, and mixture ratio of the materials were studied, with reference to the large MCCI test conducted in FY2016 by the Fuel Debris Analysis and Characterization Project team. A meeting was held with the said team to confirm that there are no issues in the idea.

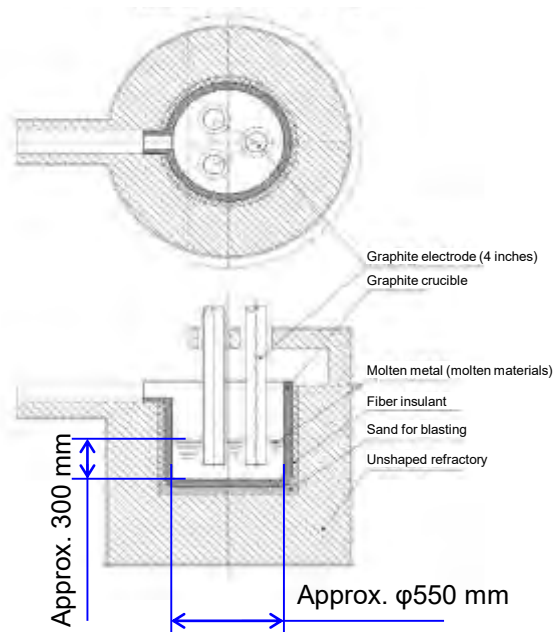

Melting test reactor
(schematic illustration)

Table: Amount of materials used to create MCCI debris simulants (per simulant)

Simulants	Material name	Density	Mixing ratio	Amount injected [kg]
Concrete	Cement	3.5	12:88	16.8
	Aggregate (SiO_2)	2.65		90.3
Ceramic fuel debris	CeO_2 (UO_2 simulant)	7.2	65:35	75.2
	ZrO ₂	5.65		31.3
Metal fuel debris	Zr	6.52	51:49	23.1
	SUS	7.6		25.6

6. Implementation details of this project

6.2. Implementation details

1) Development of Technology for Prevention of Fuel Debris Spreading

(2) Development of Fuel Debris Cutting / Dust Collection System

c. Production of fuel debris and contaminated structure simulants for processing tests

a) MCCI simulant

The manufacturing of MCCI debris simulants and the manufactured items are shown below.



After raw materials have been placed



Molten pool before formation



Molten pool when final samples are put inside



After stopping power and letting it cool down naturally



Day after melting procedure



Before conducting a processing test with chisel

6. Implementation details of this project

6.2. Implementation details

1) Development of Technology for Prevention of Fuel Debris Spreading

(2) Development of Fuel Debris Cutting / Dust Collection System

c. Production of fuel debris and contaminated structure simulants for processing tests

Material evaluation of manufactured MCCI simulants



Top: porous oxide layer

Center: dense oxide layer

- Ce, Zr, Si, Ca, Al, O are mainly detected
Matches with constituent elements of raw materials (CeO_2 , ZrO_2 , cement, crushed stone)
- $\text{Ce}_{4.66}(\text{SiO}_4)_3\text{O}$, ZrO_2
- Compressive strength: large variance, the mean of three points are 241.9 to 283.5 [MPa]
- Density: 3.96 to 4.05×10^3 [kg/m^3]

Center: shrinkage cavities

Bottom: metal layer

- Fe, Cr, Ni, Mo, C are mainly detected
Matches with constituent elements of raw material (stainless steel)
- $\gamma\text{-Fe}$, $\alpha\text{-Fe}$
- Vickers hardness: HV 514, HV 474
- Density: 7.27 , 7.47×10^3 [kg/m^3]

6. Implementation details of this project

6.2. Implementation details

1) Development of Technology for Prevention of Fuel Debris Spreading

(2) Development of Fuel Debris Cutting / Dust Collection System

d. Study and analysis of dust collection systems used for chips and dust generated during processing work

- Local collection systems applicable to chisel processing was studied.

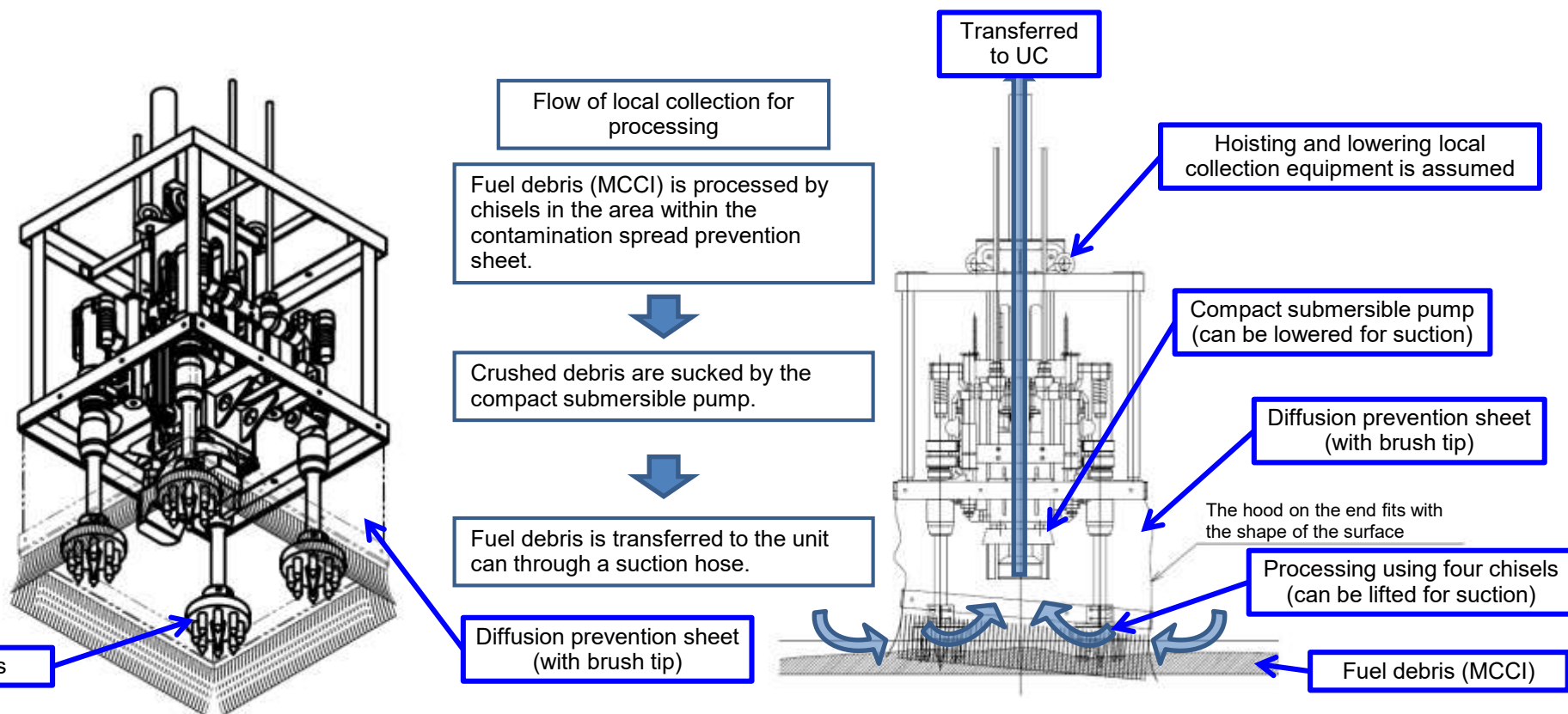

Schematic illustration of local collect equipment for chisel processing

Schematic illustration of local collection task during chisel processing

6. Implementation details of this project

6.2. Implementation details

1) Development of Technology for Prevention of Fuel Debris Spreading

(2) Development of Fuel Debris Cutting / Dust Collection System

d. Study and analysis of dust collection systems used for chips and dust generated during processing work

The system removes the produced dust in the end, but it is aimed to collect and remove dust near the processing area as much as possible.

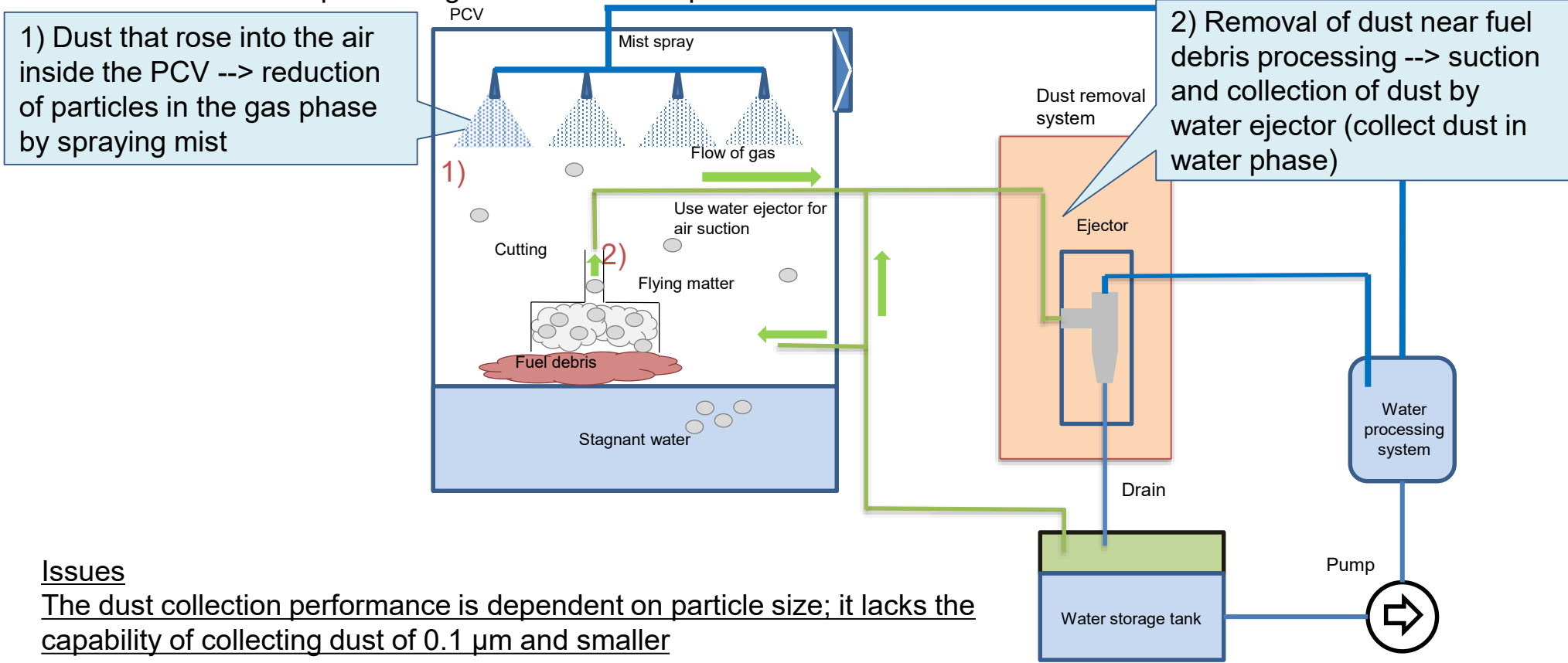

Issues

The dust collection performance is dependent on particle size; it lacks the capability of collecting dust of 0.1 μm and smaller

--> conduct study of removal performance of 0.1 μm and smaller dusts

6. Implementation details of this project

6.2. Implementation details

1) Development of Technology for Prevention of Fuel Debris Spreading

(2) Development of Fuel Debris Cutting / Dust Collection System

d. Study and analysis of dust collection systems used for chips and dust generated during processing work

Collection by mist

Study of efficiency of collecting floating particle by water mist

Parameter: mist concentration (100 ml/min., 200 ml/min.)

Test method: measure the concentration of dust particles in the atmosphere inside the container (at inlet), spray a mist of water for a certain amount of time, and then measure the concentration again (at outlet)

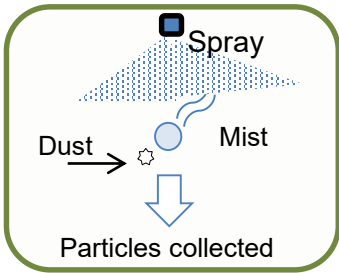

Conceptual image of dust collection

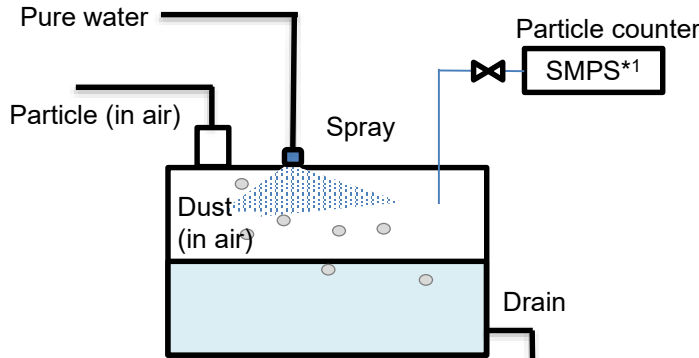

Container: 200 L (φ: 0.6 m, h: 0.9 m)

Diagram of test on removal of dust by spraying

*1: SMPS model 3081 (measurement range: 0.016 to 0.6 μm)

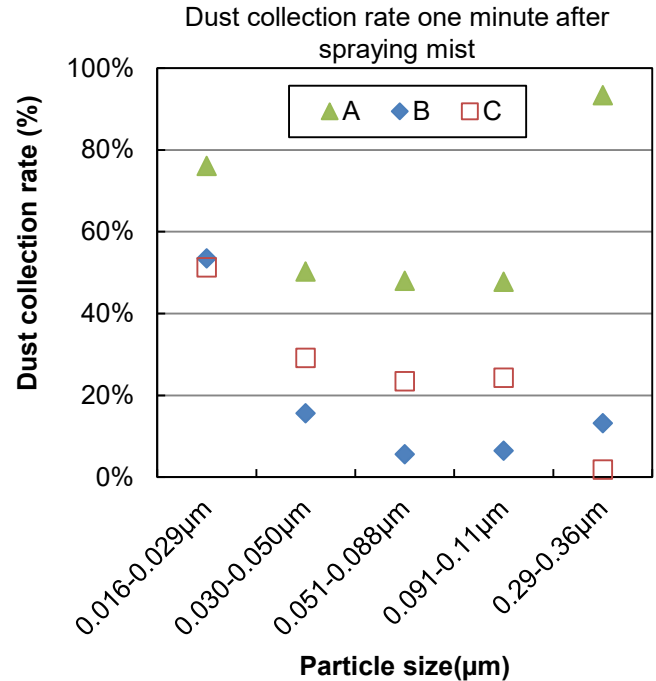

Collection rate [%] = (dust particle concentration inside the container - dust particle concentration inside the container after mist is sprayed) / dust particle concentration inside the container * 100

[Results]

- High concentration of small mist particles is preferred.
- Particles of 0.1 μm and smaller can likely be collected by mist.

[Challenges]

Developing component design and method of installation inside actual PCV

Mist nozzle specifications (detailed legend)

Legend (nozzle)	A	B	C
Nozzle type	Full-cone type	Flat type	
Particle size*2 [μm]	20	100	100
Flow rate [ml/min.]	50	100	200

*2: particle size when nozzle height is 300 mm

6. Implementation details of this project

6.2. Implementation details

1) Development of Technology for Prevention of Fuel Debris Spreading

(2) Development of Fuel Debris Cutting / Dust Collection System

d. Study and analysis of dust collection systems used for chips and dust generated during processing work

Collection by ejector

Study of efficiency of collecting floating particle by an ejector (effect of drawing in low-pressure fluid with high-pressure fluid)

Parameter: ratio of amounts of water and suction gas

Test method: measure the concentration of dust particles (before collection) after replacing the contents of the container with N₂, let water flow through an ejector and draw in air, then measure the concentration inside the container again (after collection)

Collection rate [%] = (atmospheric concentration of particles - particle concentration inside the container after using the ejector) / atmospheric concentration of particles * 100

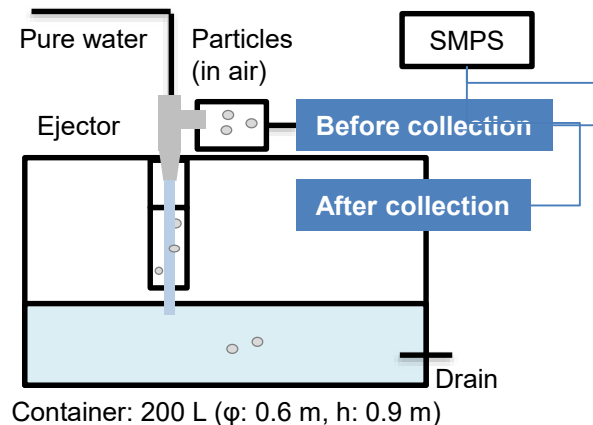
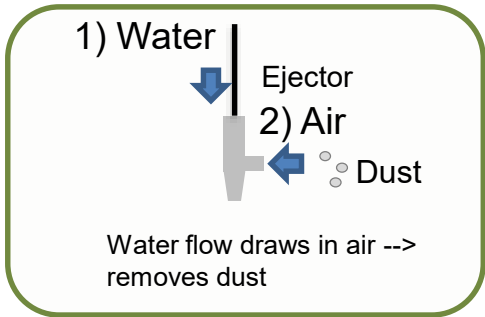
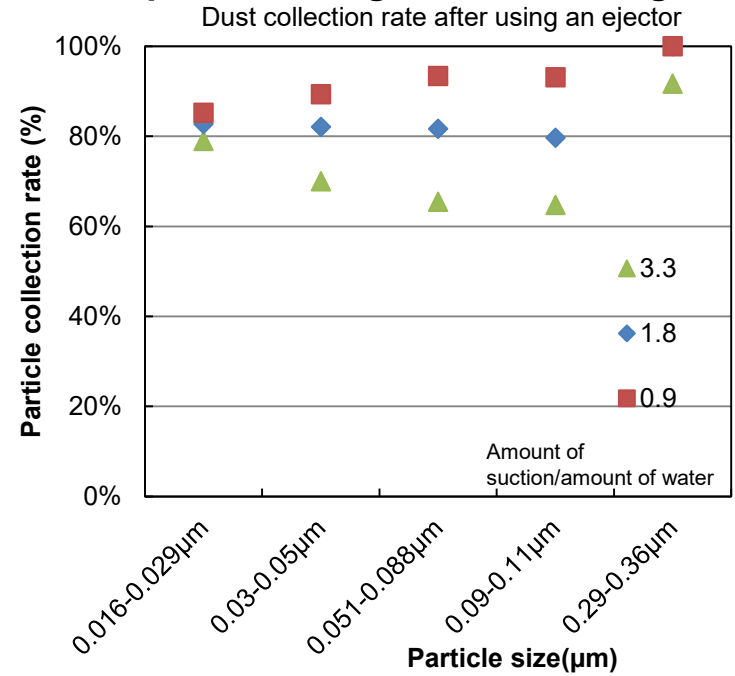

Diagram of test on collection of dust by an ejector

[Results]
- The amount of air drawn in relative to the amount of water is preferred to be small.
- Particles of 0.1 µm and smaller can likely be collected by an ejector.
[Challenges]
- Conducting study of equipment that is combined with processing and assessing the performance (impact on the gas purification system)

6. Implementation details of this project

6.2. Implementation details

1) Development of Technology for Prevention of Fuel Debris Spreading

(1) Development of Fuel Debris Collection System

(2) Development of Fuel Debris Cutting / Dust Collection System

(3) Development of Prevention Method of Fuel Debris Spreading

2) Development of Element Technology for Retrieval Device Installation

(1) Development of Element Technology for Work Cells

(2) Development of Interference Object Removal during Fuel Debris Retrieval

3) Development of Remote Maintenance Technology for Fuel Debris Retrieval Device

6. Implementation details of this project

6.2. Implementation details

1) Development of Technology for Prevention of Fuel Debris Spreading

(3) Development of Prevention Method of Fuel Debris Spreading

a. Preventive measures against the spread of contamination to the suppression chamber (S/C)

- Purpose of development
 - Verification of feasibility of a method for preventing fuel debris diffusion that can be arranged close to the debris processing point.
 - Identification of issues concerning fuel debris diffusion prevention methods.
- Issues to be solved
 - Fuel debris fragments produced by processing fuel debris in and outside the pedestal may spread by flowing out together with contaminated water into the S/C through the jet deflector.
 - The duration of the fuel debris retrieval project may be prolonged if fuel debris diffuses into the S/C and other areas as this will expand the areas where fuel debris needs to be collected from.
 - If fuel debris already exists in the S/C and other areas now, there is a risk of another criticality due to diffusion of additional fuel debris.
 - The spaces inside and outside the pedestal are narrow. The feasibility of operation by remote control needs to be confirmed.
- Approaches to development
 - Phase 1: conceptual study of contamination spread prevention methods
 - Phase 2: selection of contamination spread prevention methods
 - Phase 3: development of plan for element tests
 - Phase 4: production of prototype units for testing and implementation of element tests

6. Implementation details of this project

6.2. Implementation details

1) Development of Technology for Prevention of Fuel Debris Spreading

(3) Development of Prevention Method of Fuel Debris Spreading

a. Preventive measures against the spread of contamination to the suppression chamber

- Expected outcome
 - Feasibility of a contamination spread prevention method by jet deflector.
 - Confirmation of basic ability of implementing methods for preventing the spread of contamination regarding underwater fuel debris.
 - Results of identified issues regarding methods for preventing the spread of contamination and formulation of a development plan.

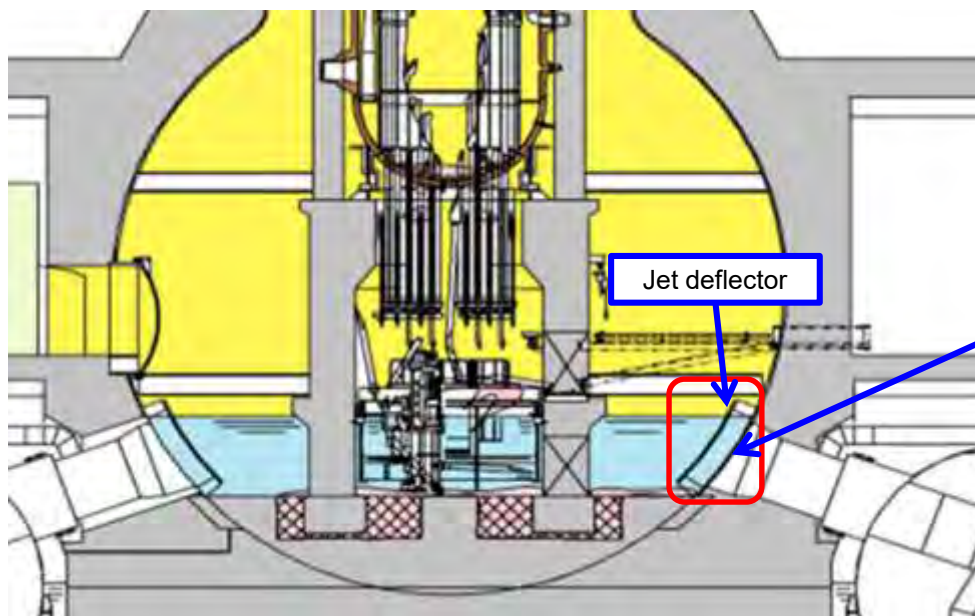

Location at which contamination spread prevention method is applied*

*Detailed study on locations at which contamination spread prevention method is applied, task procedure, period in which task is performed, etc. will be conducted during preliminary engineering.

6. Implementation details of this project

6.2. Implementation details

1) Development of Technology for Prevention of Fuel Debris Spreading

(3) Development of Prevention Method of Fuel Debris Spreading

a. Preventive measures against the spread of contamination to the suppression chamber

The overview of the development and the procedures is provided. A preliminary test will be conducted on the dike construction method in which dikes are made by pouring mortar. This method is believed to be highly realizable based on the desk study results.

No.	Items studied regarding preventive measures against the spread of contamination to the suppression chamber	Details of study and objective of tests (Confirmation items)	Conceptual study	Preliminary tests	Notes
1	Comparison between ideas of preventive measures against the spread of contamination to the jet deflector	Identify implementable ideas of preventive measures against the spread of contamination to the jet deflector and compare their feasibility.	○	—	
2	Identification of specific water stoppage methods	Conduct comparative study of specific water stoppage methods for highly feasible preventive measures against the spread of contamination to the jet deflector based on the results of comparative evaluation.	○	—	Identification of methods for constructing dikes by pouring mortar
3	Study of installation area of dikes for preventing the spread of contamination	Study the installation area of dikes for preventing the spread of contamination.	○	—	
4	Study of method for constructing dikes	Study the methods for constructing dikes for preventing the spread of contamination and identify the required functions of preventive measures against the spread of contamination.	○	—	
5	Verification of feasibility of dikes for preventing the spread of contamination	Conduct a preliminary test to confirm the feasibility of the highly realizable dike construction method in which dikes are made by pouring mortar.			
		Check installation of mold		○	
		Pour mortar		○	

6. Implementation details of this project

6.2. Implementation details

1) Development of Technology for Prevention of Fuel Debris Spreading

(3) Development of Prevention Method of Fuel Debris Spreading

a. Preventive measures against the spread of contamination to the suppression chamber

Method No. 3 of the preventive measures against the spread of contamination was selected. It was the most feasible method based on conceptual study.

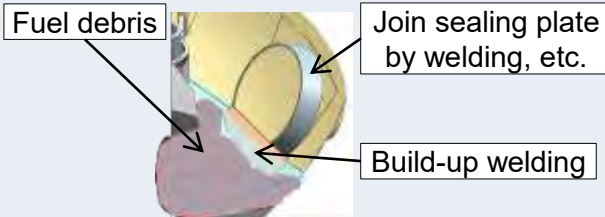
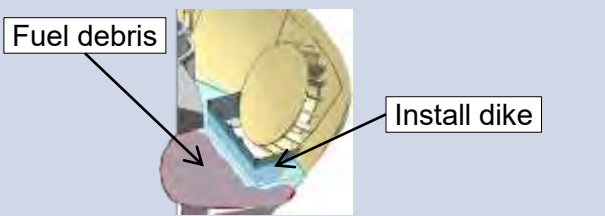
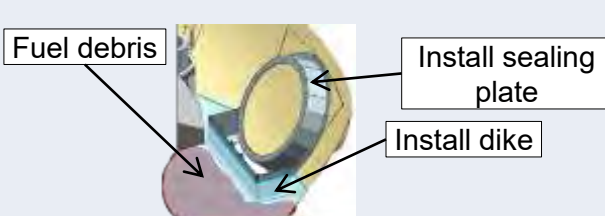
No.	Method overview	Effect of contamination spread prevention		Difficulty level of method (expectation)	Notes
		In air	Under water		
1		High	High	High	Remote welding in narrow spaces is likely to be difficult
2		Low	High	Medium	Spread of contamination in the air is likely to occur in combination with the negative pressure control system
3		Medium	High	Medium	Spread of contamination in the air is likely to occur in combination with the negative pressure control system

6. Implementation details of this project

6.2. Implementation details

1) Development of Technology for Prevention of Fuel Debris Spreading

(3) Development of Prevention Method of Fuel Debris Spreading

a. Preventive measures against the spread of contamination to the suppression chamber

Conceptual study was performed on a method for constructing dikes.

Although a method in which dikes and water stoppage materials are used together is believed to have high water stoppage ability, it likely has issues regarding construction by remote control as several elements are combined to make dikes.

To identify issues that may arise when constructing by remote control, conceptual studies and preliminary element tests were conducted on the method that combines dikes and water stoppage materials.

No.	Water stoppage method	Workability	Water stoppage ability	Assessment	Assessment
1	Dikes only (plate, sandbag, etc.)	High	Medium	○	Water stoppage is challenging if installation area has uneven ground
2	Water stoppage materials only	Low	High	△	It is difficult to remain the water stoppage material within the specified area
3	Dikes and water stoppage materials	Medium	High	○	There are issues in workability but dikes that stop water can be built in the specified area

No.	Water stoppage method	Workability	Water stoppage ability	Radiation resistance	Assessment	Assessment
1	Cement-based material	Medium	Medium	High	○	It is hard to build with but has great radiation resistance
2	Non-cement-based material (organic material)	Medium	High	Low	△	Many have low radiation resistance and requires frequent maintenance

[Legend] ○: highly feasible, △: feasible, ×: negligibly feasible

6. Implementation details of this project

6.2. Implementation details

1) Development of Technology for Prevention of Fuel Debris Spreading

(3) Development of Prevention Method of Fuel Debris Spreading

a. Preventive measures against the spread of contamination to the suppression chamber

Among the different methods that combine dikes and water stoppage materials (mortar), a preliminary element test was conducted on the method that builds dikes by pouring mortar in a mold, which is likely the most feasible.

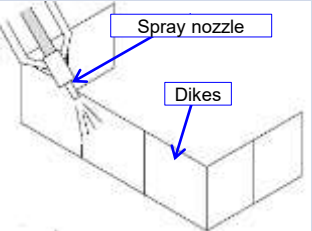
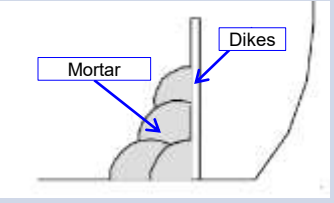
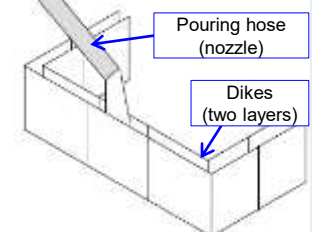
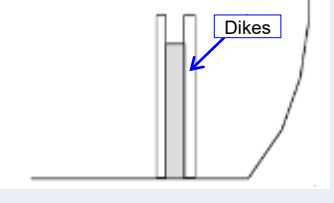
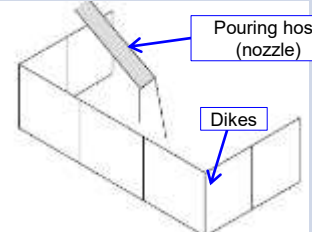
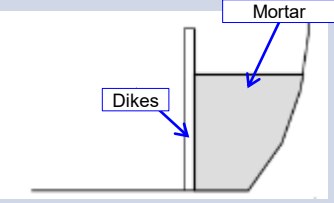
No.	Conceptual image	Cross-sectional image	Materials used	Assessment
1	 <p>Spray nozzle Dikes</p>	 <p>Mortar Dikes</p>	Sprayed mortar (cannot be used under water)	Not suitable for remote construction as nozzle needs to be moved to areas that require spraying
2	 <p>Pouring hose (nozzle) Dikes (two layers)</p>	 <p>Dikes</p>	Fluid mortar (can be used under water*) *Materials differ between those intended for underwater use and above-water use	Suitable for remote construction as it only requires mortar to be poured into the mold --> Confirm feasibility by preliminary test.
3	 <p>Pouring hose (nozzle) Dikes</p>	 <p>Mortar Dikes</p>	Fluid mortar (can be used under water*) *Materials differ between those intended for underwater use and above-water use	Suitable for remote construction but requires larger amount of mortar

6. Implementation details of this project

6.2. Implementation details

1) Development of Technology for Prevention of Fuel Debris Spreading

(3) Development of Prevention Method of Fuel Debris Spreading

a. Preventive measures against the spread of contamination to the suppression chamber

Specific design of the contamination spread prevention dikes was studied based on the investigation on the internal condition of Unit 2 PCV so that the spread of the contamination is confined within a minimum area, while the installation area of the dikes are minimized.

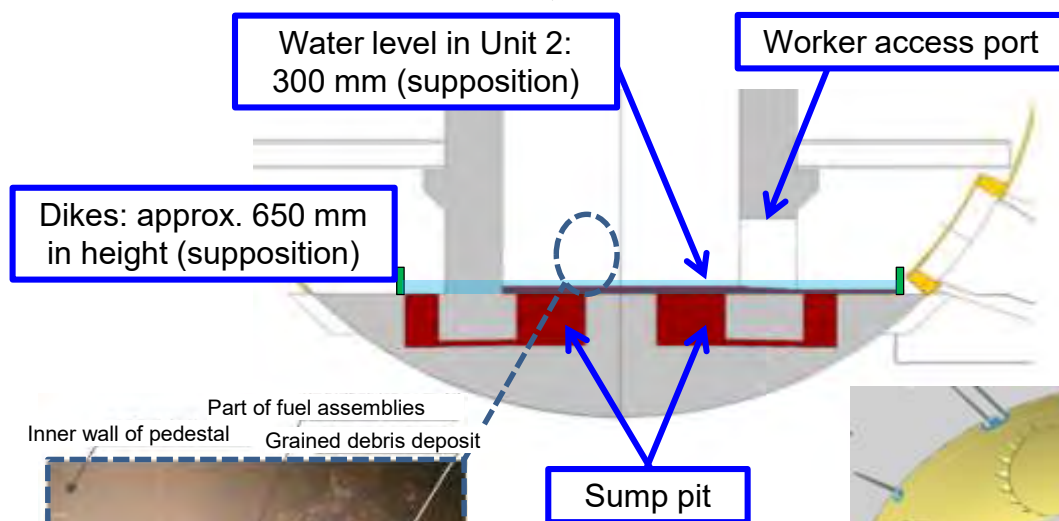

The worker access port and the sump pit are considered passages through which fuel debris in the pedestal spread outside the pedestal. Measures for contamination spread prevention were studied based on the assumption that most of the fuel debris is inside the pedestal.



Results of investigation inside PCV of Unit 2
Photo of the pedestal bottom

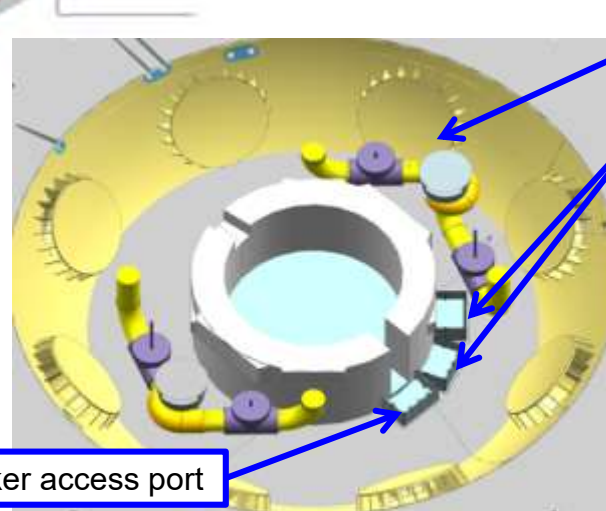

Areas to be protected by dikes can be narrowed down if all jet deflectors are completely closed. Equipment necessary for constructing dikes was studied.

6. Implementation details of this project

6.2. Implementation details

1) Development of Technology for Prevention of Fuel Debris Spreading

(3) Development of Prevention Method of Fuel Debris Spreading

a. Preventive measures against the spread of contamination to the suppression chamber

Similarly to Unit 2, a method that would minimize the construction work for preventing the spread of contamination was studied for Unit 1.

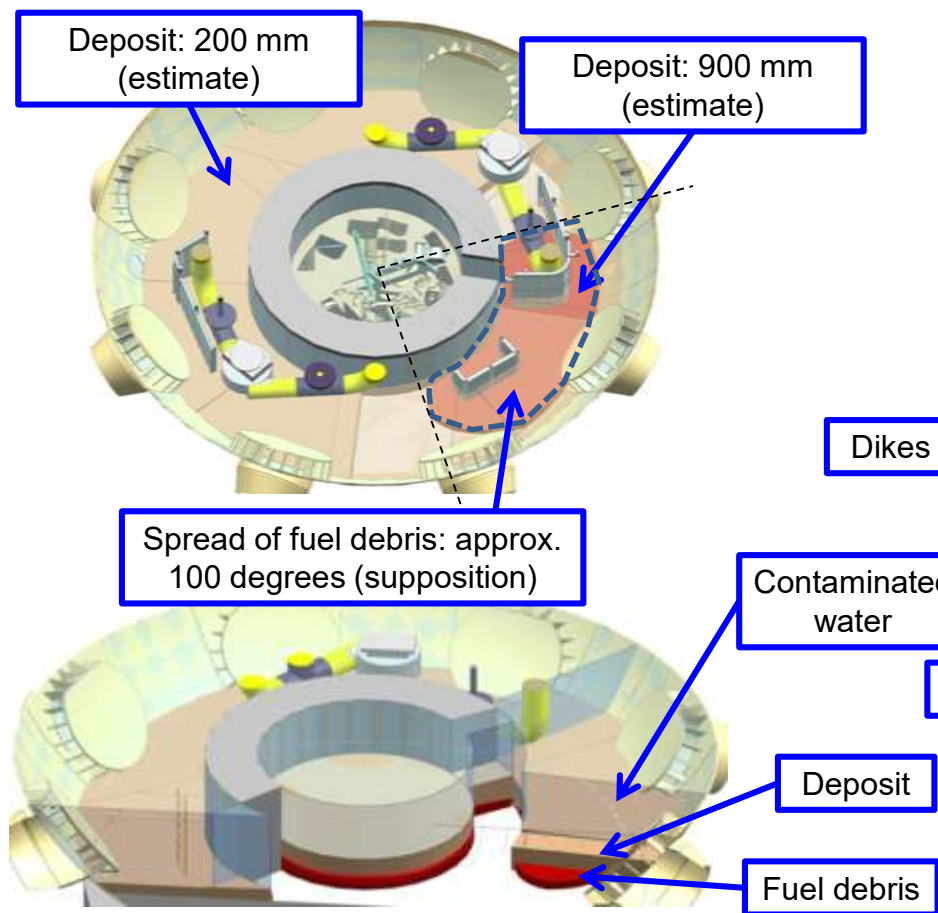

Although the total span of the dikes to be constructed will be shorter compared to the case where dikes are constructed around all jet deflectors, the water level needs to be lowered after removing the deposit. The equipment needed to install dikes was studied.

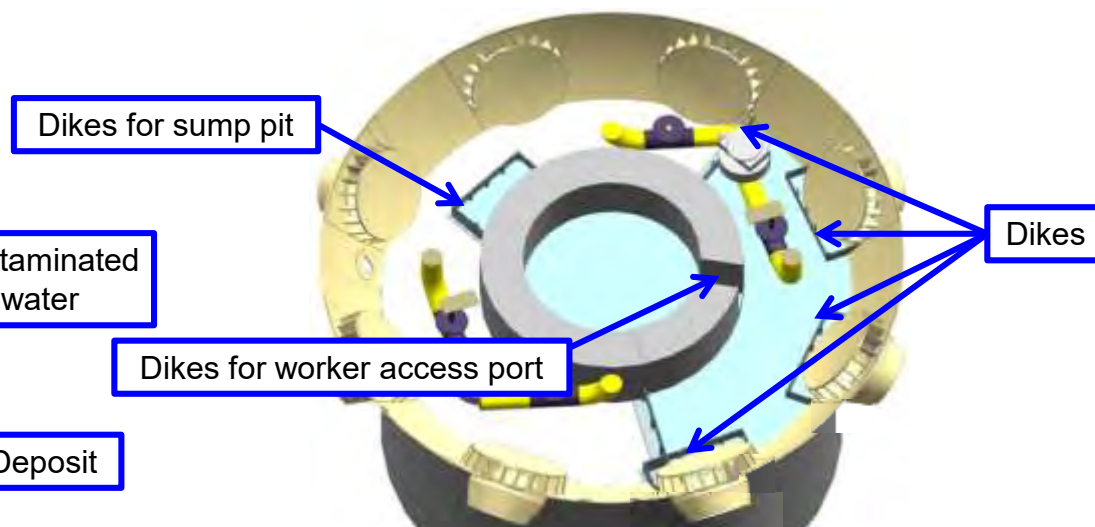

Schematic diagram of the minimized contamination spread prevention measures for Unit 1

Schematic diagram of the current spread of fuel debris in Unit 1

6. Implementation details of this project

6.2. Implementation details

1) Development of Technology for Prevention of Fuel Debris Spreading

(3) Development of Prevention Method of Fuel Debris Spreading

a. Preventive measures against the spread of contamination to the suppression chamber

A method in which dikes are constructed by installing a mold around the jet deflector and filling it with mortar was studied.

Attempts are made to achieve commonality and enhanced efficiency of tools so that the arm used to install dikes can also be used to remove fuel debris and interfering objects outside the pedestal.

[Overview of method for constructing dikes to prevent the spread of contamination]

- Mix the mortar with a mixer installed outside the PCV and transport the mortar with a pump.
- Install a mold around the jet deflector and pour in the mortar.
(Areas in which mortar is poured are above the water.)

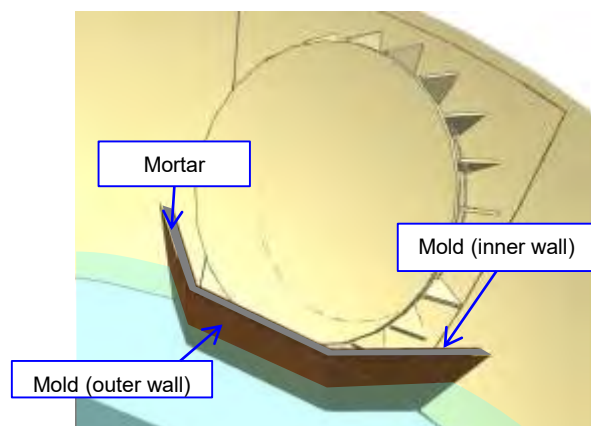

Conceptual image of dikes for preventing the spread of contamination

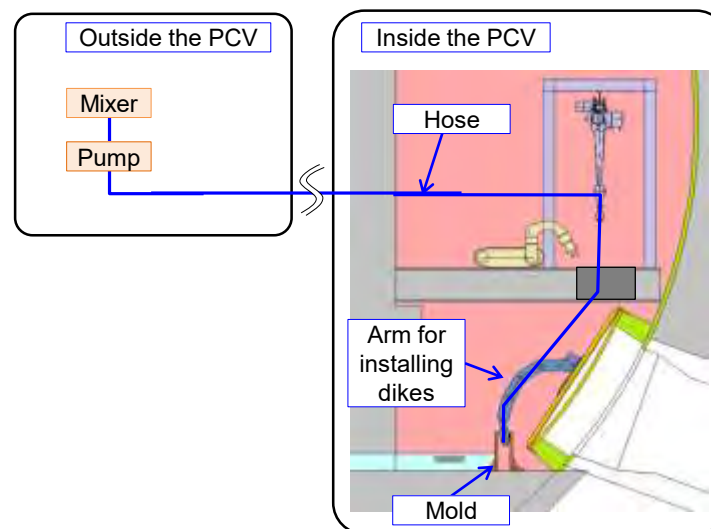

Schematic illustration of mortar pouring procedure for constructing dikes

6. Implementation details of this project

6.2. Implementation details

1) Development of Technology for Prevention of Fuel Debris Spreading

(3) Development of Prevention Method of Fuel Debris Spreading

a. Preventive measures against the spread of contamination to the suppression chamber

Work steps of measures against the spread of contamination were studied to identify necessary functions for operation and potential issues.

Test area

Work step	Prepare hole opening for grating	Create hole for grating	Prepare for equipment installation	Install arm base
Illustration of operation	<p>Hole opening equipment</p> <p>1F of D/W</p> <p>Jet deflector</p>	<p>Create hole for grating</p>	<p>Installation equipment</p>	<p>Installation equipment</p> <p>Arm base</p> <p>Installation</p>
Work step	Install arm for installing dikes	Prepare for installation of mold	Install mold	Prepare drainage inside mold
Illustration of operation	<p>Installation equipment</p> <p>Arm for installing dikes</p> <p>Installation</p>	<p>Heavy machinery for hoisting</p> <p>Work assistance equipment</p>	<p>Mold</p>	<p>Pump</p> <p>Hose</p>

6. Implementation details of this project

6.2. Implementation details

1) Development of Technology for Prevention of Fuel Debris Spreading

(3) Development of Prevention Method of Fuel Debris Spreading

Test area

a. Preventive measures against the spread of contamination to the suppression chamber

Work steps of measures against the spread of contamination were studied to identify necessary functions for operation and potential issues.

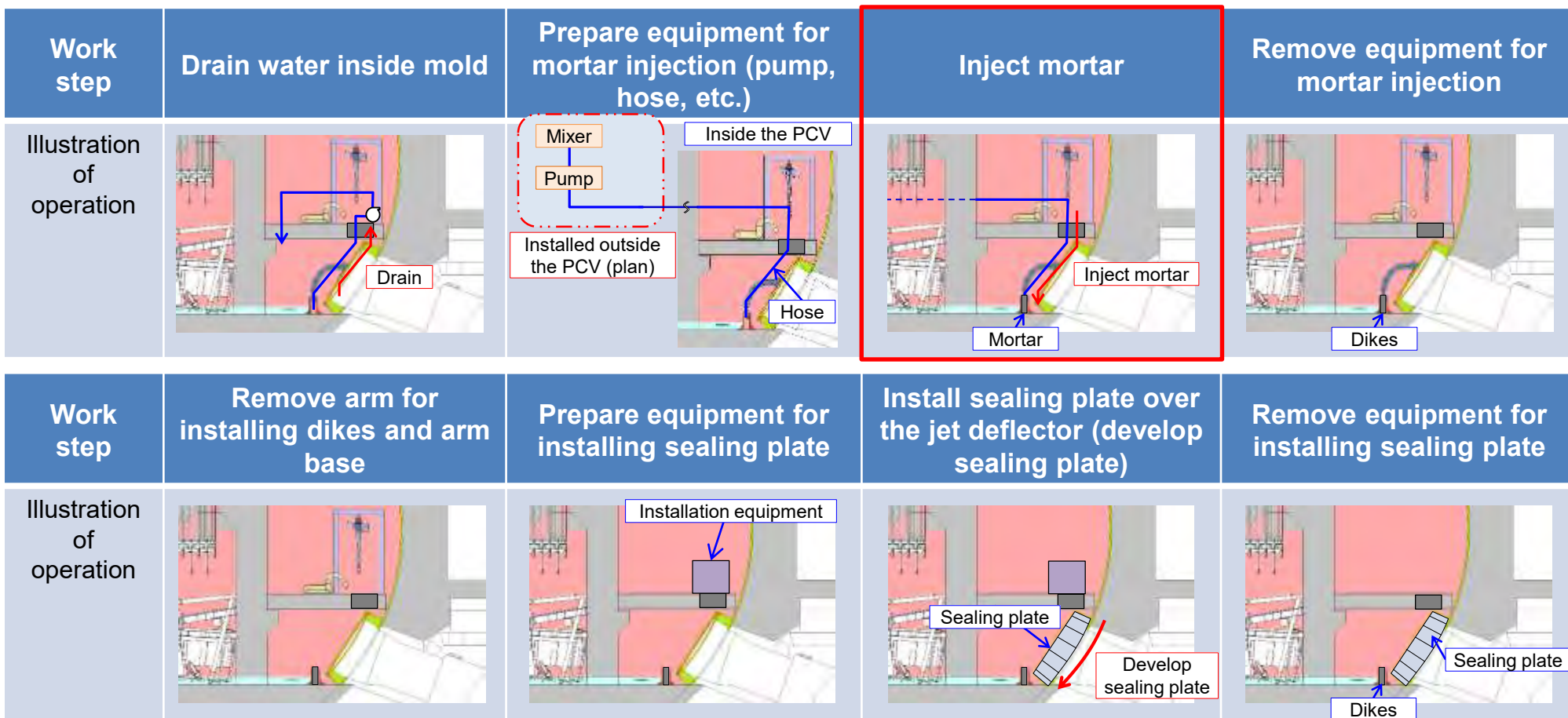

6. Implementation details of this project

6.2. Implementation details

1) Development of Technology for Prevention of Fuel Debris Spreading

(3) Development of Prevention Method of Fuel Debris Spreading

a. Preventive measures against the spread of contamination to the suppression chamber

The required functions for preventive measure against the spread of contamination was identified based on the study results of the steps of the said measure.

- Required functions of the preventive measure against the spread of contamination
 - Installation of grating opening on the 1st floor of the PCV is possible as it is required for installing the arm for installing dikes to the jet deflector.
 - Installation of arm base on the jet deflector from the grating opening on the 1st floor of the PCV is possible.
 - Installation of arm for installing dikes on the arm base on the jet deflector from the grating opening on the 1st floor of the PCV is possible.
 - Carry-in of equipment necessary for the installation of dikes from the grating opening on the 1st floor of the PCV is possible.
 - Installation of dikes around the jet deflector using the arm for installing dikes fixed on the jet deflector is possible. Installation of dikes around the personnel access port and sump pit is possible.
 - Installation of jet deflector sealing plates to prevent the spread of contamination in the air is possible (similar to dikes).
 - Monitoring of remote operation of the tasks above is possible.

6. Implementation details of this project

6.2. Implementation details

1) Development of Technology for Prevention of Fuel Debris Spreading

(3) Development of Prevention Method of Fuel Debris Spreading

a. Preventive measures against the spread of contamination to the suppression chamber

The following two tests were conducted as preliminary element tests and the feasibility of the preventive measure against the spread of contamination was verified.

(1) Verification test regarding installation of mold

Test to check whether the mold can be installed with remote control equipment.

[Confirmation items]

- Whether the mold can be installed using the arm for installing dikes.

(2) Mortar pouring test

Test to check whether dikes can be constructed by pouring mortar in the mold.

[Confirmation items]

- Whether dikes can be constructed by pouring mortar inside the mold.
(Whether there would be a problem if there is a gap between the installation surface inside the PCV and mold.)
- Whether the mold be filled with mortar by grabbing the hose with an arm for installing dikes.

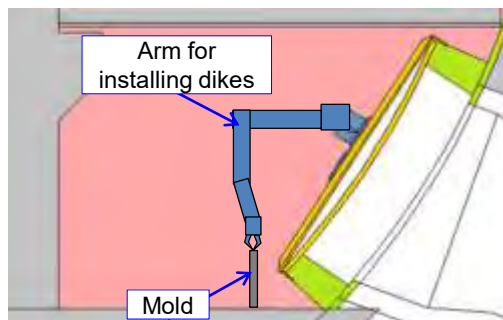

Schematic illustration of installation of mold by arm for installing dikes

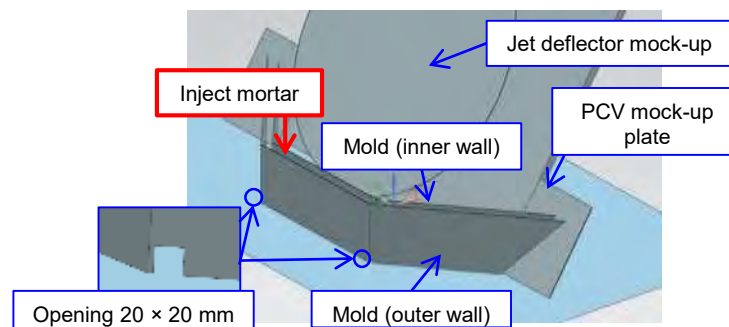

Overview of mortar injection test setup

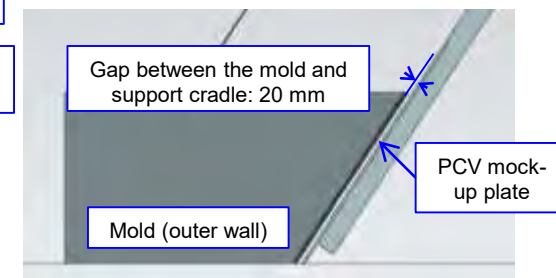

Overview of mortar injection test setup (side)

6. Implementation details of this project

6.2. Implementation details

1) Development of Technology for Prevention of Fuel Debris Spreading

(3) Development of Prevention Method of Fuel Debris Spreading

a. Preventive measures against the spread of contamination to the suppression chamber

The results of the mold installation verification test confirmed that the mold can be installed around the jet deflector using an arm for installing dikes.

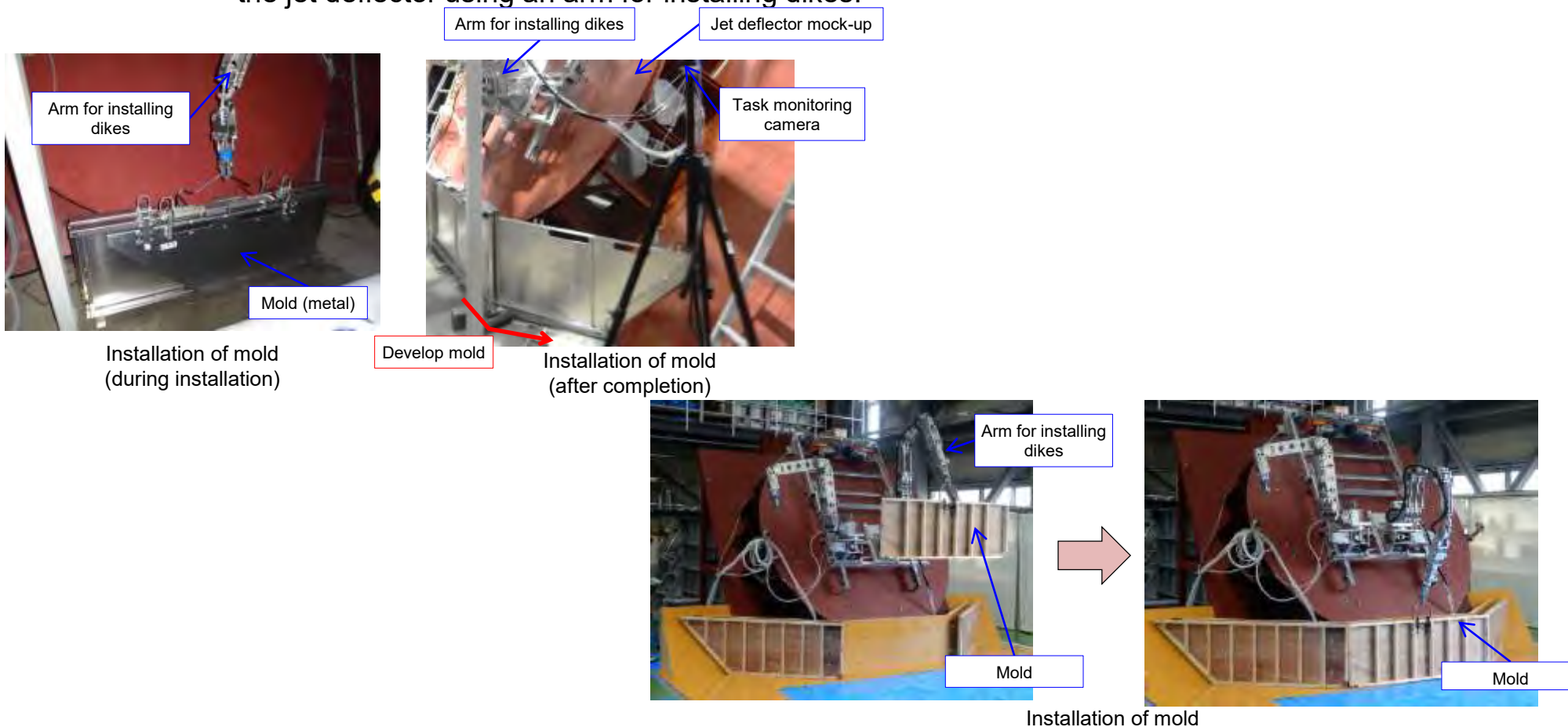

6. Implementation details of this project

6.2. Implementation details

1) Development of Technology for Prevention of Fuel Debris Spreading

(3) Development of Prevention Method of Fuel Debris Spreading

a. Preventive measures against the spread of contamination to the suppression chamber

A mortar pouring test was conducted and it confirmed that dikes can be constructed by injecting mortar in the mold.

- It was confirmed that dikes can be constructed by injecting mortar inside the mold.
- It was confirmed that mortar can fill up a gap of about 20 mm between the mold and the installation surface inside the PCV.
- The arm for installing dikes can hold the hose and fill the mold with mortar if it is within its range of motion. (Mold in areas outside the arm's range of motion was manually filled with mortar.)

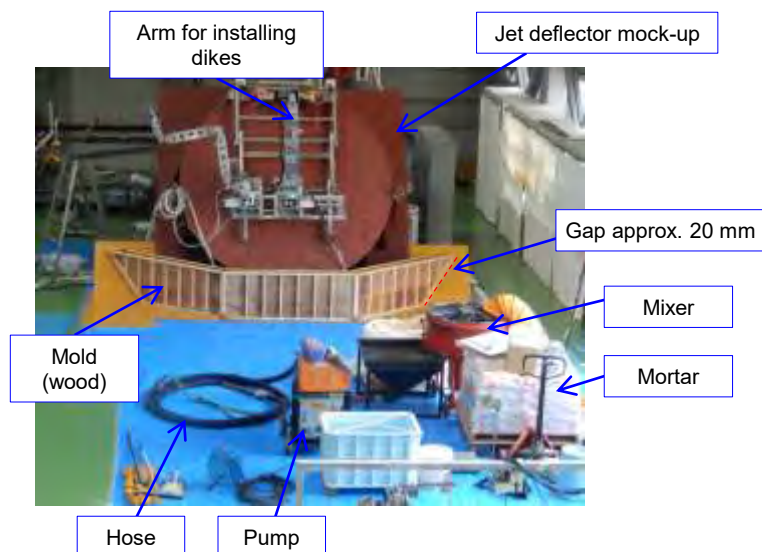

Overall view of the test area

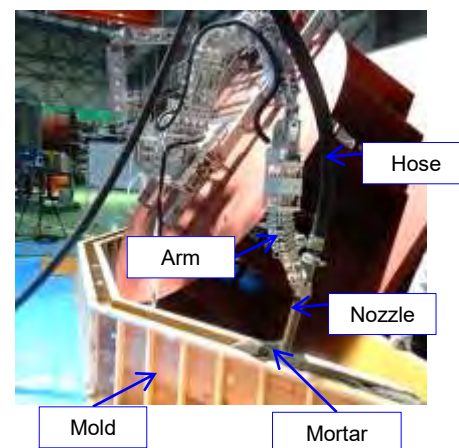

Mortar injection

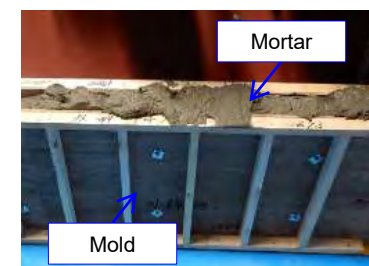

Top view of mold after pouring is complete

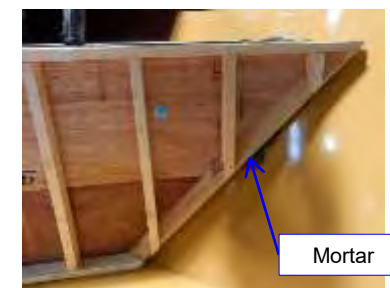

Gap after pouring is complete

6. Implementation details of this project

6.2. Implementation details

1) Development of Technology for Prevention of Fuel Debris Spreading

(3) Development of Prevention Method of Fuel Debris Spreading

a. Preventive measures against the spread of contamination to the suppression chamber

After the mortar was injected into the mold, the mold was removed and the mortar was confirmed.

- The mortar was mostly well injected and maintained the shape of the dike.
- Two through holes were found on the right as seen from the front.
- In this test, air was mixed into the mortar while the mortar flowed through the hose. By taking measures in the future, the quality of the construction is expected to improve. In addition, study of combination with the mold is also necessary.



Dike after mold was removed (outside)

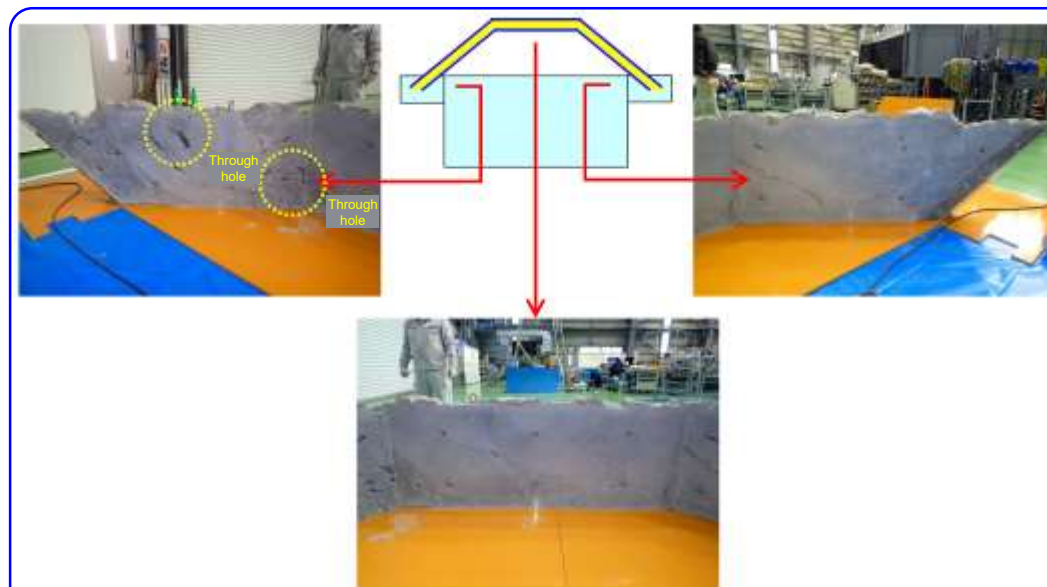

Dike after mold was removed (inside)

6. Implementation details of this project

6.2. Implementation details

1) Development of Technology for Prevention of Fuel Debris Spreading

(3) Development of Prevention Method of Fuel Debris Spreading

a. Preventive measures against the spread of contamination to the suppression chamber

Future issues and action policy

No.	Issues	Action policy*
1	It was difficult to arrange the hose that pours mortar in a specified position above the mold. (In the current set-up, the hose needs to be lowered straight down and the opening of the grating has to be larger.)	Other easier methods of creating dikes will be studied, including whether it is possible to use dikes alone (e.g., sandbags) to build dikes, and element tests will be conducted. (*) (Verification tests on the ability to install dikes by remote control equipment, verification tests on the ability of dikes to stop water, etc.)
2	After the dikes are installed, pumps and piping are likely needed to drain the water on the outside of the dikes.	Together with the tests above, verification tests on the ability of installation regarding pumps and piping for draining water on the outside of the dikes will be conducted.
3	There is a risk of leakage after dikes are installed.	In order to ensure long-term integrity, remote control repair methods will be studied.

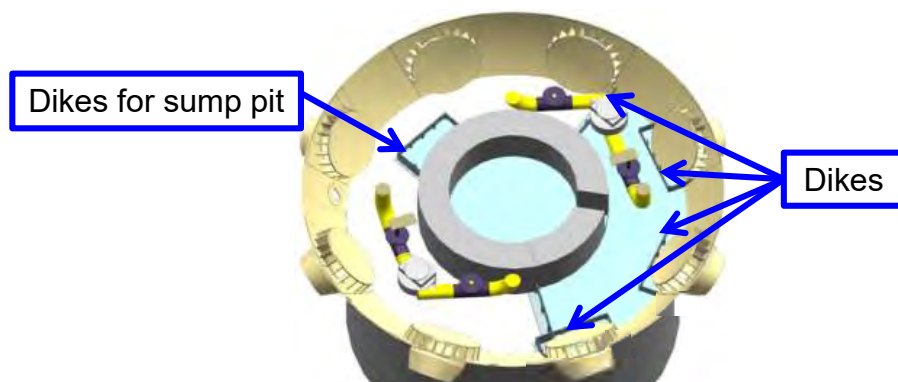

Actions with an asterisk () will be set out in the following fiscal year onward. Others will be worked on through future engineering activities.

6. Implementation details of this project

6.2. Implementation details

1) Development of Technology for Prevention of Fuel Debris Spreading

(1) Development of Fuel Debris Collection System

(2) Development of Fuel Debris Cutting / Dust Collection System

(3) Development of Prevention Method of Fuel Debris Spreading

2) Development of Element Technology for Retrieval Device Installation

(1) Development of Element Technology for Work Cells

(2) Development of Interference Object Removal during Fuel Debris Retrieval

3) Development of Remote Maintenance Technology for Fuel Debris Retrieval Device

6. Implementation details of this project

6.2. Implementation details

2) Development of Element Technology for Retrieval Device Installation

Develop the following remote technologies for each task assumed during fuel debris retrieval because the site has a high radiation level and many of the tasks must be conducted by remote control.

(1) Development of Element Technology for Work Cells

Remote operation is required to install work cells that enclose fuel debris retrieval equipment. In the side access method, for example, the sealing efficiency and strength of work cells and the access passage to the PCV (X-6 penetration, etc.), which runs through a narrow and highly radioactive area in the reactor building, must be ensured. As with the top access methods, the same requirements apply to work cells and the access passage, which is installed in a high radiation area on the operation floor right above the reactor well. Among other things, the following shall be included in the main development themes and element tests will be performed on an as needed basis. Through these activities, issues will be identified and reviewed.

a. Establishment of work cell installation methods for top access and side access, reduction of the load on the reactor building, and improvement of work cell manageability

- Design conditions applicable to cell and method review were optimized.
- Conceptual study concerning the soundness of the reactor building after installing the facilities and equipment necessary for the side access method (seismic resistance, impact of additional openings constructed in the building, load on the floor, etc.) and the feasibility of installation work (cell installation procedures, etc.) was conducted.

b. Work cell sealing method (such as welding, inflate sealing, or water sealing)

- Feasibility of the welding-based sealing method was confirmed by element tests performed until FY2016.
- Element tests on the inflation seal sealing method were conducted.

c. Assurance of work cell sealing efficiency and dust dispersion prevention performance

- Regarding work cell sealing efficiency and dust dispersion prevention performances, confinement performance to contain specified radioactive materials within the cell, working with the negative pressure control system on the system side, will be studied.

6. Implementation details of this project

6.2. Implementation details

2) Development of Element Technology for Retrieval Device Installation

(1) Development of Element Technology for Work Cells

- Purpose of development
 - Improve work cell feasibility, including cell installation methods and reactor building strength check, by identifying requirements for work cells and clarifying concept of cells.

- Issues to be solved
 - Clarification of concept of cells
 - ✓ Clarification of source term and maintenance areas
 - ✓ Study of a way to share a work cell with multiple types of robots
 - ✓ Clarification of maintenance items and methods regarding equipment in the cell
 - ✓ Enhancement and cost reduction of shielding door, double door system, and airlock system
 - ✓ Enhancement of fuel debris collection speed (throughput) by clarifying in-cell processes
 - ✓ Reduction of the shielding structures' weight

 - Clarification of the cell installation method
 - ✓ Detailed study of methods for opening a through hole in the PCV concrete
 - ✓ Study of dust dispersion prevention methods (especially a method applicable to gaps between the PVC wall and concrete structure)
 - ✓ Clarification of methods for installing heavy weight objects under a high-dose radiation environment

6. Implementation details of this project

6.2. Implementation details

2) Development of Element Technology for Retrieval Device Installation

(1) Development of Element Technology for Work Cells

- Approaches to development
 - Clarification of work cell requirements
 - Clarification of concept of cells
 - ✓ Assignment of required functions to different cell types
 - ✓ Assumption of fuel debris properties and amount of those handled
 - ✓ Calculation of the thickness of cell shielding structures
 - ✓ Study of cell structures
 - ✓ Study of cell-associated components (shielding door, airtight door, handling equipment, etc.)
 - Clarification of the cell installation method
 - ✓ Study of methods for opening a through hole in the PCV concrete
 - ✓ Study of methods for sealing connection between PCV and cell
 - ✓ Study of methods of carrying-in into cell
 - Verification of building strength
 - ✓ Assessment of the impact of openings in buildings on building strength
 - ✓ Assessment of the impact of cell installation on building strength

- Expected outcome
 - Feasibility of a series of processes from carrying in equipment in the PCV to the removal of fuel debris and interfering objects
 - Enhancement of fuel debris collection speed (throughput) by clarifying in-cell processes

6. Implementation details of this project

6.2. Implementation details

2) Development of Element Technology for Retrieval Device Installation

(1) Development of Element Technology for Work Cells

Clarification of cell-related issues based on safety requirements

Basic safety requirements	Safety requirements (example)	Issues concerning cells		Solution methods
Confinement of radioactive materials by establishing a boundary	Prevention of leakage that exceeds the allowable level specified in the safety standards for radioactive materials in gas	Confinement of radioactive materials by establishing a static boundary	Assurance of sealing efficiency of cell (door systems, through holes, etc.)	Conduct conceptual study based on existing technologies
			Sealing of connection between PCV and cell	Examine sealing efficiency in element tests since there is no record of similar applications
		Confinement of radioactive materials by establishing a dynamic boundary	Adoption of a door system	Conduct conceptual study based on existing technologies (double door, airlock, etc.)
Protection against external exposure	Installation of shields for preventing direct radiation exposure in excessive amounts	Shielding of cell against external radiation		Clarify the source term and fuel debris flow line and conduct a conceptual study
Development of a design for dose reduction of workers	Development of appropriate design for installation of shields as well as configurations for classification of contamination and dose, in addition to designs for a system for remote maintenance and traffic line setting to reduce exposure	Shielding of worker access areas against cells		Clarify areas where workers are allowed to enter and conduct a conceptual study
		Carrying-in and installation in cells, layout, and traffic lines		Clarify in-cell processes and conduct a conceptual study
		Maintenance of cells and in-cell equipment		Clarify equipment subject to maintenance, method of maintenance, and location of implementation, and conduct a conceptual study Plan element tests as necessary
Management of operation for dose reduction of workers	Development of operation methods, maintenance plans, and an operation management system for dose reduction of workers	Function allocation among cells, layout, and traffic lines		Clarify in-cell processes and conduct a conceptual study
		Maintenance of cells and in-cell equipment		Clarify equipment subject to maintenance, method of maintenance, and location of implementation, and conduct a conceptual study Plan element tests as necessary

6. Implementation details of this project

6.2. Implementation details

2) Development of Element Technology for Retrieval Device Installation

(1) Development of Element Technology for Work Cells

a. Establishment of work cell installation methods for top access and side access, reduction of the load on the reactor building, and improvement of work cell manageability

- Design conditions applicable to cell and method review

Inputs that could be reflected on the design conditions concerning cell and method study were organized, and hypothetical conditions for items for which input is not obtained was set. Note that the conditions may be updated when a new input is available.

Item	No.	Detailed item	Design conditions, etc.	Notes
Item No. 1 Radiation-related items	1	Source strength of fuel debris	The source strength after a cooldown period of 10 years that is described in JAEA-Data/Code 2012-018 is used.	
	2	Radiation dose in the PCV	1. Inside the pedestal (same among Units 1 to 3) 100 to 1,000 Sv/h 2. Outside the pedestal (same among Units 1 to 3) 10 to 100 Sv/h	The fall of reactor internals and results of site survey are taken into account
	3	Radiation dose in the reactor building	Current radiation dose in each area shall be used.	
	4	Radiation dose on the outer surface of a cell shielding structure	1. Restricted areas for worker in a normal condition: 1 mSv/h or less 2. Worker accessible areas: 0.1 mSv/h or less 3. Radiation dose is determined through coordination with the System Project team.	

6. Implementation details of this project

6.2. Implementation details

2) Development of Element Technology for Retrieval Device Installation

(1) Development of Element Technology for Work Cells

a. Establishment of work cell installation methods for top access and side access, reduction of the load on the reactor building, and improvement of work cell manageability

- Design conditions applicable to cell and method review

Item	No.	Detailed item	Design conditions, etc.	Notes
Item No. 2 Reactor building and seismic resistance	1	Load capacity of floors above ground	1. Unit 1: 1.22 ton/m ² in front of X-6 penetration, 4.88 ton/m ² in front of manhole 2. Units 2 and 3: 4.9 ton/m ² in front of X-6 penetration, 1.22 ton/m ² in other areas	
	2	Seismic acceleration	1. Seismic acceleration is estimated to be 900 Gal. 2. Seismic acceleration is determined through coordination with the Anti-seismic Project team.	
	3	Cell height	1. The height of cells installed in the reactor building shall be equal to or less than the height of the ceiling on the 1st floor of the reactor building. 2. The height of the cells vary between processing methods and required functions.	
Item No. 3 Dimensions of openings for access constructed on the wall of PCV and inside the pedestal	1	Equipment hatch size	1. Unit1: ϕ 3.0 m 2. Units 2 and 3: H2.5 m	
	2	X-6 penetration opening size	1. Whether it is usable as an access port and whether the opening needs to be enlarged depends on the construction method. 2. Conditions of the opening after completing sampling work and conditions for taking over will be coordinated with the Sampling Project team.	
	3	Pedestal opening size	1. Unit1, CRD opening: H1,970 mm × W790 mm Worker access port: H1,724 mm × W755 mm 2. Units 2 and 3, CRD opening: H1,900 mm × W750 mm Worker access port: H1,900 mm × W750 mm	
	4	Pedestal strength	1. It is assumed that the pedestal retains the original strength. 2. Integrity of the pedestal will be verified by internal investigation and other means.	
	5	Water levels in the PCV	1. The water level in the PCV can be controlled. 2. The water level in the PCV shall be equal to or lower than the floor on the 1st floor of the reactor building. (For a side access method)	

6. Implementation details of this project

6.2. Implementation details

2) Development of Element Technology for Retrieval Device Installation

(1) Development of Element Technology for Work Cells

a. Establishment of work cell installation methods for top access and side access, reduction of the load on the reactor building, and improvement of work cell manageability

- Design conditions applicable to cell and method review

Item	No.	Detailed item	Design conditions, etc.	Notes
Item No. 4 Fuel debris collection method	1	Definition of fuel debris	<ol style="list-style-type: none"> 1. Fuel debris that exists in the area under the upper grid plate (excluding CRD rail) is regarded as fuel debris. 2. As with the fuel debris outside the pedestal, material that leaks from the pedestal through the worker access gate is regarded as fuel debris. 	Defined by this project
	2	Lump-like fuel debris	<ol style="list-style-type: none"> 1. Fuel debris with a diameter that exceeds 10 mm is defined as lump-like fuel debris. 2. Any lump-like fuel debris that is larger than the unit can will be collected after it is processed into pieces of smaller size that fit. 3. Those that are smaller than the unit can and don't require processing will be collected as is. 	
	3	Particulate fuel debris	<ol style="list-style-type: none"> 1. Fuel debris with a diameter of 0.1 mm to 10 mm is defined as particulate fuel debris. 2. It will be collected by suction or equivalent means. 	
	4	Powdery fuel debris	<ol style="list-style-type: none"> 1. Fuel debris with a diameter less than 0.1 mm is defined as powdery fuel debris. 2. It will be collected by suction or equivalent means. 3. If fuel debris is collected in the water treatment system of the plant, concrete method will be arranged separately down the road. 	
	5	Criticality of fuel debris	Methods for controlling re-criticality will be coordinated with the Criticality Project Team.	
	6	Fuel debris collection area	<ol style="list-style-type: none"> 1. Inside the pedestal, fuel debris in all areas to a depth not less than the drain sump pit will be collected. 2. Outside the pedestal, fuel debris in all areas to a depth not less than the drain sump pit will be collected. 3. Specific collection work areas will be determined based on the investigation and sampling results. 	
	7	Method for processing lump-like fuel debris	See sections concerning fuel debris cutting and dust collection systems in this report.	
	8	Unit can	<ol style="list-style-type: none"> 1. Unit cans shall be $\phi 400$ mm \times H400 mm or smaller. 2. Unit can with a diameter of 200 mm is the default size. The Method Study Team will select sizes from those that are suggested by the Canister Project Team. 	

6. Implementation details of this project

6.2. Implementation details

2) Development of Element Technology for Retrieval Device Installation

(1) Development of Element Technology for Work Cells

a. Establishment of work cell installation methods for top access and side access, reduction of the load on the reactor building, and improvement of work cell manageability

- Design conditions applicable to cell and method review

Item	No.	Detailed item	Design conditions, etc.	Notes
Item No. 4 Fuel debris collection method	9	Storage canister	<ol style="list-style-type: none"> 1. Storage canisters shall be $\phi 400$ mm \times H2,000 mm or smaller. 2. Unit can with a diameter of 200 mm is the default size. The Method Study Team will select sizes from those that are suggested by the Canister Project Team. 	
	10	Cask	Transfer cask specifications will be determined through discussions with the Canister Project Team.	
	11	Dehydration and drying of fuel debris	<ol style="list-style-type: none"> 1. The unit can shall be designed so that it can dewater the fuel debris inside. 2. If the control of the fuel debris fluid is judged effective for hydrogen generation according to the Canister Project Team's reevaluation, dehydration and drying methods will be studied further as necessary. 3. The debris fluid shall be discussed with the Canister Project Team and the Criticality Project team regarding $\phi 400$ mm storage canisters, which may pose a risk of re-criticality due to its shape. 	
	12	Measures against hydrogen generation from fuel debris	<ol style="list-style-type: none"> 1. Waiting for evaluation by the Canister Project Team. 2. The control of fuel debris fluid and/or the vent of containers shall be studied 3. when measures against hydrogen generation during fuel debris 4. transportation is necessary. 	
	13	Material accountancy items for unit can	Material accountancy related to safeguards is studied by the initiative of JAEA separately from the subsidized project.	
	14	Material accountancy items for storage canister	<ol style="list-style-type: none"> 1. Material accountancy related to safeguards is studied by the initiative of JAEA separately from the subsidized project. 2. The gross mass of containers will be measured by a typical weighing method. 	
	15	Pre-carry-out inspection and material accountancy items for cask	Material accountancy related to safeguards is studied by the initiative of JAEA separately from the subsidized project.	

6. Implementation details of this project

6.2. Implementation details

2) Development of Element Technology for Retrieval Device Installation

(1) Development of Element Technology for Work Cells

a. Establishment of work cell installation methods for top access and side access, reduction of the load on the reactor building, and improvement of work cell manageability

- Design conditions applicable to cell and method review

Item	No.	Detailed item	Design conditions, etc.	Notes
Item No. 5 Collection of interfering objects and wastes	1	Definition of interfering object	Any object that needs to be removed for fuel debris retrieval is defined as an interfering object.	
	2	Radiation dose of interfering objects	Radiation dose shall be 1,000 mSv/h or less.	
	3	Ways to distinguish between fuel debris and waste	Definitions of fuel debris and waste are being discussed by another project team.	
	4	Order of interfering object dismantlement	Objects to be removed and range of dismantlement vary with the processing method.	
	5	Waste collection can	1. The can shall be able to dewater wastes inside it. 2. The dimensions of the can shall be smaller than the PCV openings.	
	6	Waste removal container	Details will be studied in the Waste Project.	
	7	Interfering object processing and cutting method	Different processing methods need to be studied since types of obstacles to be processed and the area of removal work vary depending on the method.	
	8	Criteria to approve the carrying out of wastes	1. Waste removal containers shall be inspected for radiation dose, among other things, before leaving the facility. 2. The criteria will be studied in the Waste Project.	

6. Implementation details of this project

6.2. Implementation details

2) Development of Element Technology for Retrieval Device Installation

(1) Development of Element Technology for Work Cells

a. Establishment of work cell installation methods for top access and side access, reduction of the load on the reactor building, and improvement of work cell manageability

- Design conditions applicable to cell and method review

Item	No.	Detailed item	Design conditions, etc.	Notes
Item No. 6 Operation and maintenance of access device	1	Carrying in/out of access device	<ol style="list-style-type: none"> Maintain the boundary during carrying in/out tasks. The access equipment varies with the processing method. 	
	2	Utility supply to access device	<ol style="list-style-type: none"> Utilities required depend on methods. The drive source (such as oil hydraulic, water hydraulic, and electric) of access device varies depending on the method. 	
	3	Maintenance of access device	<ol style="list-style-type: none"> Simple maintenance tasks such as replacing cameras will be performed in the reactor building remotely. Maintenance items vary with the processing method. 	
	4	Camera replacement	The radiation resistance of cameras shall be 100 kGy.	
	5	Access equipment replacement frequency	The target radiation resistance of access device is 1 MGy.	
	6	Emergency retrieval of access device	<ol style="list-style-type: none"> An access device shall be designed and installed so that it can be removed in case of failure. The emergency collection method varies with the processing method. 	
	7	Replacement of tip tools	The method for replacing tip tools varies with the processing method.	

6. Implementation details of this project

6.2. Implementation details

2) Development of Element Technology for Retrieval Device Installation

(1) Development of Element Technology for Work Cells

a. Establishment of work cell installation methods for top access and side access, reduction of the load on the reactor building, and improvement of work cell manageability

- Design conditions applicable to cell and method review

Item	No.	Detailed item	Design conditions, etc.	Notes
Item No. 7 Cell operation and maintenance	1	Fuel debris retrieval amount	The target amount is beyond 300 kg/day.	
	2	Classification of cells by contamination level	Cells are classified into three areas by contamination level: high-level, mid-level, and low-level contaminated areas.	
	3	Negative pressure control in a cell	<ol style="list-style-type: none"> The pressure of the secondary boundary shall be maintained at around -64 PaG. (Pressure difference to the atmosphere) A differential pressure of about 100 PaG per contamination classification difference shall be maintained at the primary boundary between two adjacent cells. 	
	4	Cell ventilation	<ol style="list-style-type: none"> Cells shall be ventilated to cope with hydrogen generation. The use of nitrogen needs to be discussed with the team responsible for the system of the plant. 	
	5	Cell operation and maintenance	<ol style="list-style-type: none"> The operation and maintenance of a cell are implemented in principle by remote control. Tasks undertaken by workers shall be considered only in case of emergency where the remote system does not work. 	
	6	Cell location	<ol style="list-style-type: none"> An extension building shall be constructed outside the reactor building. Layouts inside and outside the reactor building vary with the processing method. 	
	7	Method for monitoring conditions in a cell	Temperature, pressure, radiation dose, neutron dose, hydrogen concentration, oxygen concentration, visual observation by cameras, etc. in a cell shall be monitored.	
	8	Fuel debris and waste transfer	<ol style="list-style-type: none"> Contamination spread prevention measures shall be taken during transfer. The definitive means of transfer will be casks. 	
	9	Cell installation method	The cell installation method varies with the processing method.	
	10	Connection of cells and PCV	<ol style="list-style-type: none"> Connection shall take into account contamination spread prevention and confinement. The methods and means of connecting vary with the processing method. 	
	11	Method for decontaminating the inside of a cell	<ol style="list-style-type: none"> Specific decontamination methods shall be studied. The methods and means of decontamination vary with the processing method. 	

6. Implementation details of this project

6.2. Implementation details

2) Development of Element Technology for Retrieval Device Installation

(1) Development of Element Technology for Work Cells

a. Establishment of work cell installation methods for top access and side access, reduction of the load on the reactor building, and improvement of work cell manageability

- Study concerning reduction of load to the reactor building

- Measures to satisfy the load capacity of floors were studied to reduce the load on the reactor building.

PLAN-A			PLAN-B			PLAN-C		
<p>Layout example (Unit 2)</p>			<p>Layout example (Unit 1)</p>			<p>Layout example (Unit 2)</p>		
Weight of cell in reactor building	Load on floor	Capacity of load on floor	Weight of cell in reactor building	Load on floor	Capacity of load on floor	Weight of cell in reactor building	Load on floor	Capacity of load on floor
Weight reduction partly under consideration	4.9 ton/m ² or less	4.9 ton/m ²	800 ton	0 ton/m ²	4.88 ton/m ²	Weight reduction partly under consideration	7 ton/m ² or less	4.9 ton/m ²
<ul style="list-style-type: none"> This plan is based on the idea of laying out all the cells straight and constructing a relatively large opening on the outer wall of the reactor building. The cells are carried in and installed via conveyor rails from outside the reactor building. The reinforcement of the opening needs to be considered to maintain the integrity of the reactor building (since the reactor building carries a relatively large load) A reduction in the load on the floor in which a load was released outside using a suspension-bridge type structure was partly studied. The weight of the cells is supported by BSW and the anchorage outside the reactor building. 			<ul style="list-style-type: none"> A method for connecting the extension building built outside the reactor building and the PCV with an access tunnel was studied. Study was conducted on the assumption that the access tunnel weight will be supported by the BSW and the reactor building wall at both ends, and no additional load is exerted on first floor of the reactor building. 			<ul style="list-style-type: none"> Cells, transfer carriages, etc. are laid out on the 1st floor of the reactor building. Equipment requiring maintenance and fuel debris are transferred by the transfer carriage to the external extension building. The equipment cell and the transfer carriage are laid out on the main beam so that additional margin to the load capacity of the floor can be obtained. Some of the methods for reducing the load on the floor by distributing the load with steel floor plates were studied. 		

6. Implementation details of this project

6.2. Implementation details

2) Development of Element Technology for Retrieval Device Installation

(1) Development of Element Technology for Work Cells

a. Establishment of work cell installation methods for top access and side access, reduction of the load on the reactor building, and improvement of work cell manageability

- Study concerning reduction of load to the reactor building

- The action policy was set to meet the floor load restriction and issues were identified.

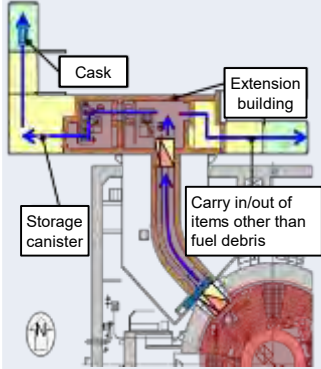
No.	Cell installation case	Preparatory work for reactor building internal structures				Action policy of cell installation	Issues	Notes
		Wall	Wall reinforcement	Column	PCV			
1	PLAN-B: method of opening through the wall of the reactor building and leaving columns as they are 	Remove	—	—	Use existing openings	1. The load exerted on the 1st floor of the reactor building needs to be minimized to secure a margin for installation of the system equipment on said floor. 2. For the dose reduction of workers, an access tunnel connects the extension building and PCV by a cantilever structure. 3. No additional load shall be exerted on the 1st floor of the reactor building during installation work. 4. After installing the access tunnel, it needs to be supported by the BSW and the reactor building wall at both ends so that no additional load is exerted on the 1st floor of the reactor building.	1. The feasibility of the construction of the access tunnel in narrow areas on the construction route. 2. Feasibility of achieving accurate mating of the access tunnel front end to the PCV opening. 3. Feasibility of heavy weight object handling. 4. Feasibility of the sealing method of the connection between the access tunnel and the PCV.	
2	PLAN-A: method of opening through the wall of the reactor building and reinforcing borehole	Remove	Yes	—	Build new opening	Partly being studied in detail.		
3	PLAN-C: method without opening through the wall of the reactor building	—	—	—	Build new opening			

6. Implementation details of this project

6.2. Implementation details

2) Development of Element Technology for Retrieval Device Installation

(1) Development of Element Technology for Work Cells

a. Establishment of work cell installation methods for top access and side access, reduction of the load on the reactor building, and improvement of work cell manageability

- Study concerning reduction of load to the reactor building

- The specific structure of the cell (access tunnel) was designed by incorporating measures against issues. In addition, element tests were conducted in the Upgrading of Approach and Systems for Retrieval of Fuel Debris and Internal Structures project to assess the feasibility of the conceptual study results.

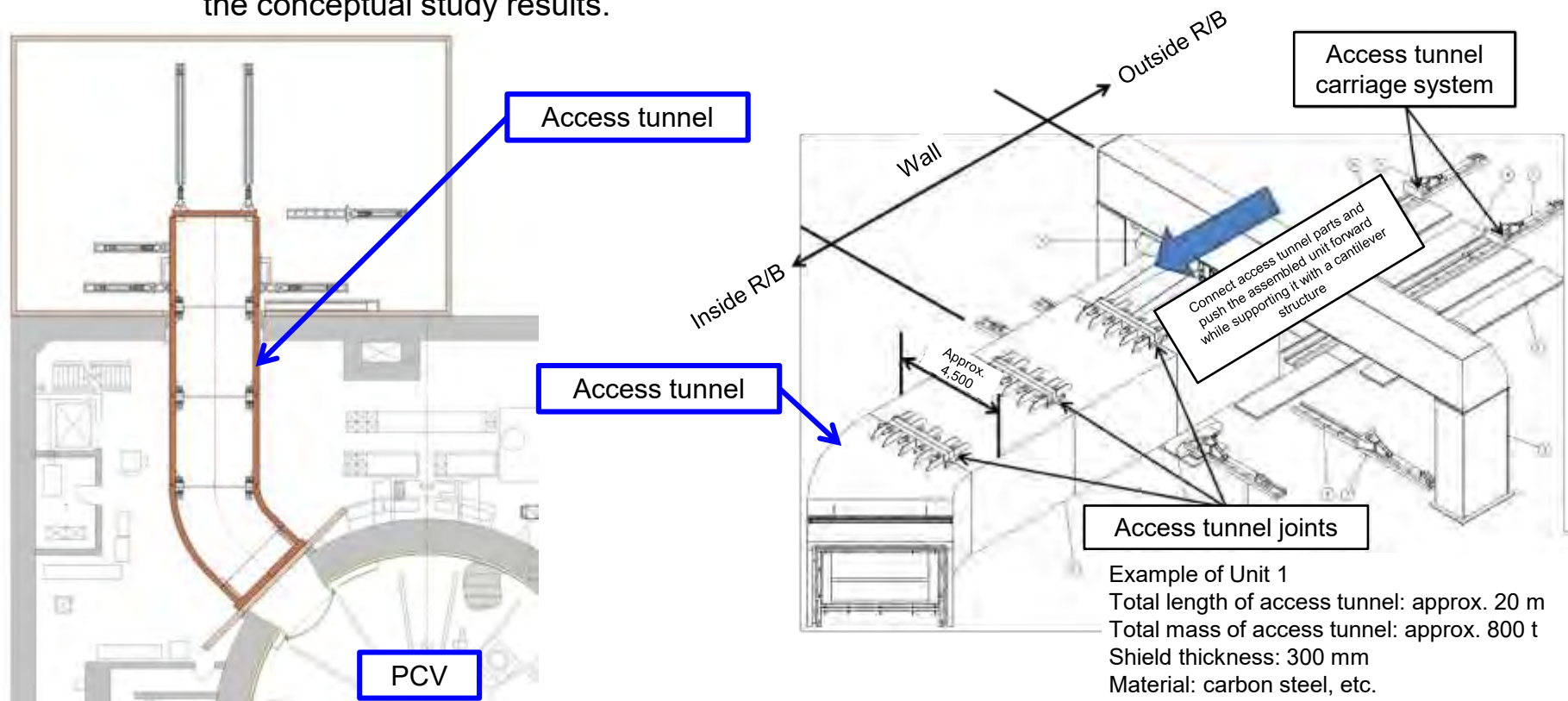

6. Implementation details of this project

6.2. Implementation details

2) Development of Element Technology for Retrieval Device Installation

(1) Development of Element Technology for Work Cells

a. Establishment of work cell installation methods for top access and side access, reduction of the load on the reactor building, and improvement of work cell manageability

- Preparatory studies for reactor building structure

The studies of the buildings will be conducted in cooperation with the plant owner and those involved in construction.

- The general evaluation on the impact of installed facilities and equipment on the seismic resistance of the reactor building is under consideration, assuming both the side access and the top access methods are used in combination.
- Impact of openings constructed on the reactor building wall and the PVC wall, on the seismic resistance of the reactor building was assessed.
- Installation and fixing methods of the fuel debris retrieval cell was studied with consideration of floor load capacity.
- Installation procedure of the fuel debris retrieval cell was studied with consideration of the integrity of the reactor building.

6. Implementation details of this project

6.2. Implementation details

2) Development of Element Technology for Retrieval Device Installation

(1) Development of Element Technology for Work Cells

b. Study of methods for sealing method between PCV and cell

● Main design specifications of cell adapter

Welding method	One side TIG fillet weld
Beveling	None (considering accessibility by torch)
Main materials	SM490B (welding part), SUS316, etc.
Function	Assurance of sealing efficiency for maintaining negative pressure
Inspection	[Before welding] gap check, [after welding] appearance check, pressure resistance test, leak test
Others	- Seismic displacement is absorbed by bellows (displacement of 20 mm in both horizontal and vertical directions is assumed) - Planning to adopt a double-bellows (thin plate) system for redundancy

● Issues regarding sealing by welding

➤ The feasibility of sealing by welding was verified by the welding test conducted (using a partial model) in FY2016.

1) Remaining and predicted issues

Collect useful data on welding (review of welding conditions, techniques, and equipment, methods of welded joint repair, handling of mill scales that are generated in TIG welding on rare occasions, temporary fitting method, etc.)

Select and verify the adequacy of a method for removing paint and rust off the PCV surface

Develop a method for aligning beveled edges that will be welded together (remote-controlled beveling and alignment of the beveled edges based on surface measurement)

Study the feasibility of producing a metallic double bellows (thin plate) (assure redundancy; if there is an alternative mechanism, it will be studied as well)

Verify the integrity of the material used for the PCV (remote verification of Unit 1, including estimation by measuring hardness and examination of materials removed from the PCV opening)

2) Collect useful data concerning welding work (to be implemented in addition when it becomes necessary in the course of discussions with regulatory authorities)

3) Verify selected welding methods using test samples that simulate actual structures (full-scale models) (including the verification of construction procedures, temporary fitting methods, and the degree of deformation [that cannot be known in tests with samples])

4) Welder training

[Supplemental remarks] 2) and (3) are done to also enhance remote control welding techniques and narrow down welders and (4) to train welders which have been narrowed down.

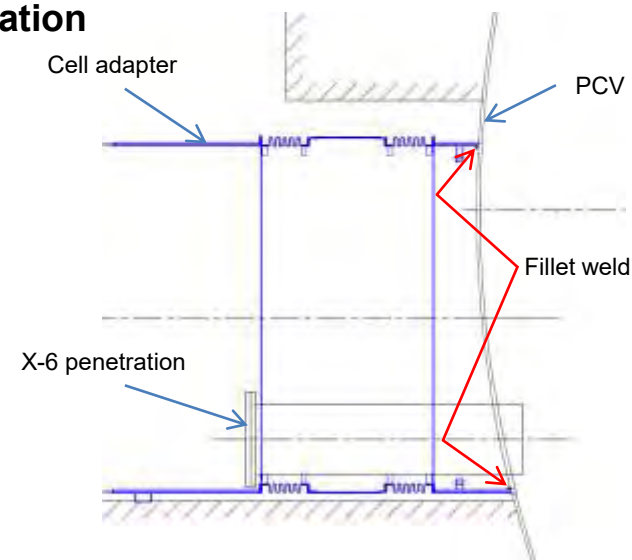

6. Implementation details of this project

6.2. Implementation details

2) Development of Element Technology for Retrieval Device Installation

(1) Development of Element Technology for Work Cells

b. Work cell sealing method (such as welding, inflate sealing, or water sealing)

● Comparison of sealing methods

[A]: Advantage, [B]: Issue (issues identified in the tests), [C]: Disadvantage or issue

Comparative item		Inflate seal (EPDM)	Weld
Features	Sealing efficiency	[A] The material fits flexibly with the undulation of sealing surfaces that may be encountered in the actual work site and provides good seal performance [C] The seal material needs to be replaced regularly by remote operation	[A] PCV and cell are permanently sealed [C] Remote control welding is difficult.
Workability	Difficulty of work (including remote control work)	[A] The material is highly applicable to irregular sealing surfaces [B] Sealing by remote control was tested on actual size workpiece samples as remote operation is difficult	[A] Since remote control welding is difficult, remote control welding was tested on sample parts (bevel gap, 3D curved surface) and the feasibility of the method was verified. [C] It is necessary to establish a method in which the welding tool follows surface undulation by reflecting the measurements of the PCV surface to the edge preparation operation as well as a method for aligning beveled edges by remote operation. [C] It is necessary to establish a method of repairing welded joints as well as a method to take care of mill scales that form in TIG welding on rare occasions. [C] Verification of the welding method using a full-scale model is necessary, including verification of a temporary fitting method and the impact assessment of deformation by welding.
	Verification and inspection	[B] Verified by testing.	[A] Appearance and leaks were inspected.
Maintainability	Maintenance and replacement	[B] Seal needs to be replaced periodically. Maintenance of sealed surface, assurance of alternative boundary, and seal replacement task were tested as remote operation is difficult.	[A] Normally, only monitoring is required.
Response to emergencies and accidents	Deterioration of seal	[A] Seal needs to be replaced periodically as it deteriorates by radiation. [A] Relative displacement caused by earthquakes, etc. can be absorbed by its flexibility and the inertial force is negligible.	[A] Relative displacement and inertial force caused by earthquakes, etc. can be absorbed by the bellows. [A] The deterioration of seal performance will likely not occur because a corrosion margin is incorporated in carbon steel in advance.
	Detection of abnormality	[A] The deterioration of seal material can be detected by monitoring the inner pressure of the seal material [C] Sealing performance is monitored indirectly by monitoring the pressure of the boundary	[C] Sealing performance is monitored indirectly by monitoring the pressure of the boundary
	Restoration	[B] Seal is restored the same way as it is replaced Restoration was tested on an actual equipment	[C] Restoration is possible by spraying seal material but requires avoidance of interference by fuel debris retrieval device
Waste	Generation of waste material	[C] Waste materials are produced when seals are replaced.	[A] No waste is normally produced.
Record of actual use	Nuclear facilities, etc.	[A] It is commonly used as a component of the boundary of cells constructed in reprocessing facilities [C] There are no records of large seals replaced by remote control, only small seals	[A] Boundaries commonly use welding [C] Alignment of beveled edges, temporary fitting, and proper welding work by remote operation is difficult

6. Implementation details of this project

6.2. Implementation details

2) Development of Element Technology for Retrieval Device Installation

(1) Development of Element Technology for Work Cells

b. Work cell sealing method (such as welding, inflate sealing, or water sealing)

- Overview of development

Overall view of operation

BSW mock-up

Shielding door mock-up

Drywell manipulator

PCV mock-up

*Main tests are conducted in a blackout environment

Remote control desk

Manipulator operation desk

- ✓ The mock-up opening created in the BSW opening test is prepared for inflate seal installation. Preparations include removal of burrs and sealing of gap between the mold and concrete.
- ✓ Transport plates are installed and removed by remote control using the drywell manipulator.
- ✓ Seals are installed and replaced by remote control using the drywell manipulator. Work procedures and arm positioning data are established through tests and the seal is confirmed using camera images to see whether it is properly installed.
- ✓ The sealing efficiency (airtightness) was confirmed (while changing the state of the sealing surface).

6. Implementation details of this project

6.2. Implementation details

2) Development of Element Technology for Retrieval Device Installation

(1) Development of Element Technology for Work Cells

b. Work cell sealing method (such as welding, inflate sealing, or water sealing)

● Overview of development

Qualifying conditions of unit test: Applicability of inflate seal as a boundary is evaluated. If it is applicable, element tests on sealing efficiency of inflate seals shall be conducted. Qualifying conditions of combination test: Element tests concerning the remote control replacement of inflate seals are conducted and feasibility of remote control replacement is verified.

Legend:
 ◎: Intended result was obtained
 △ Some issues remain
 [B] Intended result was not obtained
 -: Not tested

Phase	Purposes of tests (Test items)	Unit test	Combination test	Notes
a) Preparation before installation of seal				
Surface treatment on installation surface	Data on methods for removing irregular solid objects from the gap between the BSW and PCV as well as removing burrs and warps of BSW mold by remote operation is obtained.	—	◎	Conducted manually
Caulking	Fill the gap between the BSW mold and concrete with caulking and obtain data for remote operation.	—	◎	Conducted manually
b) Installation of seal				
Installation and replacement of inflate seal	Inflate seals can be transported, installed, and replaced by remote operation using a drywell manipulator.	—	◎*	—
	Visually check that the inflate seal is inserted inside the gap between the BSW and PCV and is installed in the correct position of the BSW opening without twists, etc.	—	◎	—
	The seal can be confirmed after installation on whether it achieves the target performance.	—	◎	—
c) Sealing efficiency				
Sealing efficiency during normal operation	The seal functions on curved surfaces with weld reinforcement and bumps on mold and without guide grooves.	◎	◎	—
Sealing efficiency when pressure provided to the seal is lost	Seal maintains its sealing efficiency with its elasticity without internal pressure.	◎	◎	—

*It was confirmed that the inflate seal can be inserted by remote control in gaps between the BSW and PCV if the space is within the design scope. However, it was difficult to install the seal in gaps that are narrower than the design value (less than 44 mm).

6. Implementation details of this project

6.2. Implementation details

2) Development of Element Technology for Retrieval Device Installation

(1) Development of Element Technology for Work Cells

b. Work cell sealing method (such as welding, inflate sealing, or water sealing)

- Overview of development: know-how obtained from test 1) Preparation before installation of seal

Verification item	Data	Notes
Surface treatment on installation surface (e.g., brush)	Burrs were removed and the installation surface was cleaned with a flap wheel, both by manual operation. By grasping the work procedure pattern, feasibility of this task by remote control using a manipulator is in prospect.	
Caulking	Caulk was applied manually on uneven parts and joints of the BSW mold. By grasping the work procedure pattern, feasibility of this task by remote control using a manipulator is in prospect.	

6. Implementation details of this project

6.2. Implementation details

2) Development of Element Technology for Retrieval Device Installation

(1) Development of Element Technology for Work Cells

b. Work cell sealing method (such as welding, inflate sealing, or water sealing)

- Overview of development: know-how obtained from test 2) Installation of seal (1/2)

Verification item	Data	Notes
Common items	<ul style="list-style-type: none"> - It was confirmed that remote control operations concerned with transfer, installation, and replacement of the seal were enabled by drywell manipulator and bird's eye camera used in this project. - The optimum camera and lighting arrangement data was obtained by a series of remote control operations using the testing facility that simulates the actual environment. - As workers got familiar with the procedure day by day, the operation was conducted in a shorter period of time. Further reduction of operation time on the actual equipment is in prospect by enhancing the skills of the workers even more. 	
Transfer of transport plate	<ul style="list-style-type: none"> - It was confirmed that the transport plate can be transferred and installed by remote control using a drywell manipulator. - Estimated time on actual equipment: 3h 	Time required from the transport plate attached to the manipulator to it installed on the PCV wall
Installation of inflate seal	<ul style="list-style-type: none"> - It was confirmed that inflate seals can be installed in the specified position between the BSW and PCV by remote operation using a drywell manipulator. However, it was difficult to install the seal in gaps that were narrower than the design value. - Confirmation items and work procedure that enable the installation of inflate seals were established. The arm position data in each step was obtained. - Estimated time on actual equipment: 42h 	<p>In the test, approx. 1/3 of the area had a narrow gap where seals were difficult to install. The overall time was calculated based on the actual time taken to install the seal in the remaining 2/3.</p> <p>Time required from the replacement of the tip tool of the manipulator to the completion of inserting inflate seals in gaps between the BSW and PCV.</p>

6. Implementation details of this project

6.2. Implementation details

2) Development of Element Technology for Retrieval Device Installation

(1) Development of Element Technology for Work Cells

b. Work cell sealing method (such as welding, inflate sealing, or water sealing)

- Overview of development: know-how obtained from test 2) Installation of seal (2/2)

Verification item	Data	Notes
Removal of inflate seal	- It was confirmed that the inflate seal can be removed and transferred to the equipment cell by remote control. - Estimated time on actual equipment: 4h	Testing time: 4hours Time required to remove the inflate seal and transfer it to the equipment cell
Transfer of transport plate	- It was confirmed that the transport plate can be connected to the manipulator and transferred to the equipment cell by remote control. - Estimated time on actual equipment: 3.5h	Testing time: 3.5 hours Time required to connect the transport plate installed on the PCV with the manipulator and install it tentatively in the equipment cell
Installation position and twist	- It was confirmed that the proper installation of the inflate seal, without twists, can be confirmed visually by camera.	

3) Sealing efficiency

Verification item	Data	Notes
Sealing efficiency test 1) Installed by manipulator (normal situation)	Amount of leakage: 1.5 m ³ /h (qualifying standard: 40 m ³ /h) Amount of leakage satisfies the qualifying standard.	Space pressure: 300 Pa Inflate seal pressure: 0.08 MPa
Sealing efficiency test 2) Installed by manipulator (loss of pressure supply)	Amount of leakage: 6.3 m ³ /h (qualifying standard: 40 m ³ /h) Amount of leakage satisfies the qualifying standard even during loss of pressure supply.	Space pressure: 300 Pa Inflate seal pressure: 0 MPa
Sealing efficiency test 2) Installed manually (no caulking)	Amount of leakage: 3.6 m ³ /h (qualifying standard: 40 m ³ /h) Amount of leakage satisfies the qualifying standard even when there is no caulking on the mold of BSW.	Space pressure: 300 Pa Inflate seal pressure: 0.08 MPa

6. Implementation details of this project

6.2. Implementation details

2) Development of Element Technology for Retrieval Device Installation

(1) Development of Element Technology for Work Cells

b. Work cell sealing method (such as welding, inflate sealing, or water sealing)

● Purpose of development

- The objective is to establish methods and technology for enhancing the sealing efficiency (seal) between the PCV and cell. This is one of the methods of constructing boundaries for confinement of radioactive materials, which is the most important in the safety requirements.
- Methods and technology for installing and replacing seals by remote control shall be established.
 - ✓ The following items are included in the study of construction of confinement boundary.
 - Enhancement of sealing efficiency of existing primary boundary (PCV, etc.)
 - > studied by the Methods and Systems Project team
 - Design of sealing efficiency of newly constructed primary boundary (cells, etc.)
 - > Studied in this project
 - Control of negative pressure in the primary boundary --> studied by the Methods
 - ✓ The following are studied in advance as methods of sealing gap between the PCV and cell.
 - Sealing by welding (right diagram)

Although this method is likely to be highly reliable in the long run, execution of work is difficult and has restrictive conditions (gaps, etc.)

--> feasibility of remote control welding was proven by element tests conducted until the previous fiscal year
 - Sealing by seal material (organic seal material, etc.)

Compared with welding, this method has better workability and can be applied to a wider range of area but requires regular replacement.

(this method has been used in short-term tasks (no replacement) such as investigation inside PCV)

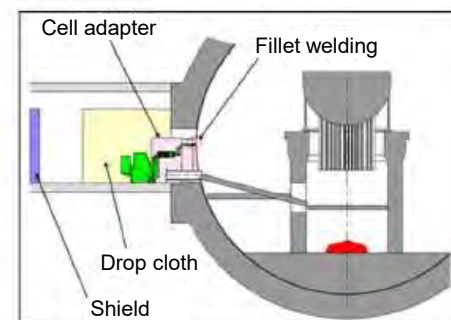

● Issues to be solved

- The applicability of sealing method using seal materials on gap between the fuel debris retrieval work cells and PCV requires inspection (including long-term operation).
- The feasibility and safety of installation and replacement of seal material by remote control need to be examined.

6. Implementation details of this project

6.2. Implementation details

2) Development of Element Technology for Retrieval Device Installation

(1) Development of Element Technology for Work Cells

b. Work cell sealing method (such as welding, inflate sealing, or water sealing)

[1] Sealing method and seal performance

(a) Method for achieving required functions

- Construction of a boundary formed by the PCV, cell, and connecting part (sealing part) between the PCV and cell
- Control of negative pressure inside a boundary to prevent leakage of radioactive material that exceeds a permissible amount
- The following means shall be considered as candidates for sealing methods:

➤ Sealing by welding

- This method is expected to be highly reliable in the long run.
- Execution of work is difficult and conditions (gaps, etc.) are restrictive.
=> The feasibility of remote construction of seals by welding was proved by element tests performed until last fiscal year.

➤ Sealing by seal material

- This method has better workability and can be applied to a wider range of area than weld sealing.
- There is an issue involving use over a long period of time since periodic replacement is required.

==> Its feasibility of replacement was verified in this technical development.

Both welding and seal material methods will be developed continuously in parallel since each method has its own issues and it's not possible to select one at this point in time.

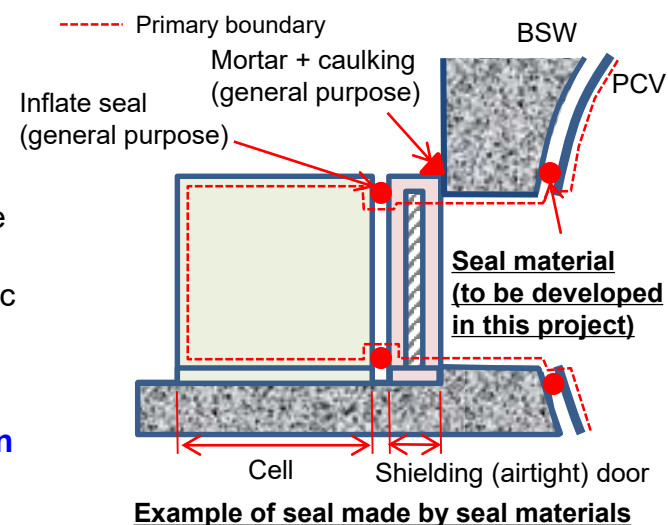
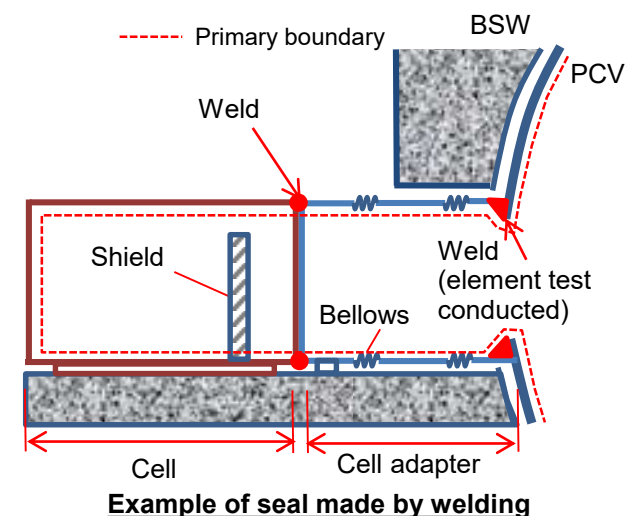

6. Implementation details of this project

6.2. Implementation details

2) Development of Element Technology for Retrieval Device Installation

(1) Development of Element Technology for Work Cells

b. Work cell sealing method (such as welding, inflate sealing, or water sealing)

[1] Sealing method and seal performance

(b) Selection and evaluation of materials used for the inflate seal

EPDM (ethylene propylene diene monomer, commonly known as ethylene propylene rubber) was chosen as the seal material. This material has been used in nuclear facilities and has high radiation resistance as well as an excellent balance of properties such as resistance to heat and hot water. Urethane rubber also has radiation resistance equivalent to that of EPDM. However, it compares unfavorably with EPDM regarding heat and hot water resistance. Data shows that EPDM has radiation resistance of approximately 10^6 [Gy], meaning that it can maintain for about a year and two months under exposure to 100 Sv/h.

	Ethylene-propylene rubber EPDM	Urethane rubber	Fluororubber	Silicone rubber
Sealing efficiency	○ Widely used as generic seal material. Superior in hot water resistance.	× Widely used as generic seal material. However, resistance to heat, water, and humidity is low.	○ Widely used as generic seal material. Superior in hot water resistance.	× Widely used as generic seal material. However, it is inferior in resistance to gas permeation.
Workability	○ Widely used and superior in workability.	○ Widely used and superior in workability.	○ Widely used and superior in workability.	○ Widely used and superior in workability.
Actual schedule	◎ Widely used under environment with radiation and has a proven track record.	× Use in nuclear facility is relatively rare.	○ Used under environment with radiation and has a proven track record.	◎ Widely used in nuclear facilities and has a proven track record.
Radiation resistance	◎ Superior in radiation resistance compared with other rubber materials.	◎ Superior in radiation resistance compared with other rubber materials.	△ Inferior to EPDM and urethane rubber.	△ Inferior to EPDM and urethane rubber.
Total evaluation	◎	×	△	×

◎ Excellent, ○ Good, △ Acceptable

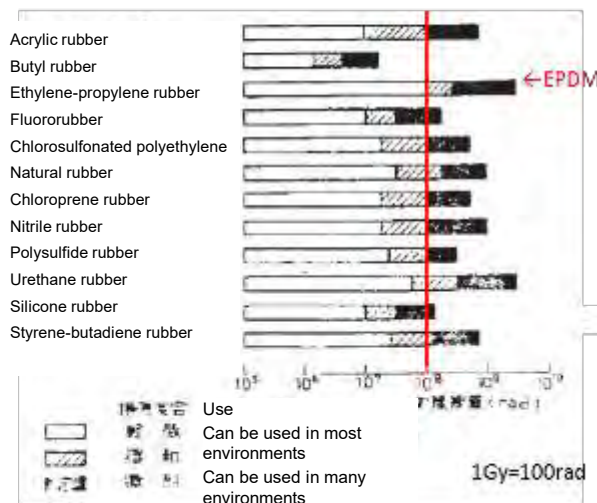

Cited from "Polymeric Materials for Atomic Power Industry" published by Japan Atomic Energy Research Institute

6. Implementation details of this project

6.2. Implementation details

2) Development of Element Technology for Retrieval Device Installation

(1) Development of Element Technology for Work Cells

b. Work cell sealing method (such as welding, inflate sealing, or water sealing)

[1] Sealing method and seal performance

(c) Selection of the cross-section shape of seal

Cross-sectional shapes of seals were narrowed down to rectangular and rhombic seals based on the evaluation summarized in the following table. Further study of the cross-sectional shape of seals will be conducted by putting weight on rhombic shape seals. Self-sustained recovery in an emergency and sealing efficiency was emphasized in determining the direction of study.

Evaluation item		Evaluation of cross-section shapes			
		Rectangular	Diamond	Mound-shaped	Lip type
Sealing efficiency	Gap between BSW and PCV (width of approx. 50 mm, 3D spherical surface)	○	○	○	△: Poor flexibility and ability to fit with a given shape
	Absorption of displacement caused by thermal expansion or earthquake	○	○	○	△: Poor flexibility and ability to fit with a given shape
	Crossing with uneven weld lines of the PCV	△: Leakage risk involved	△: Leakage risk involved	×: Leakage due to small contact face	×: Leakage due to small contact face
Handling ability	Handling with remote control equipment (carry in, installation, and replacement)	○	○: Insertion possible when inside has negative pressure	×: No foldability △: Resistance during insertion	△: Projection of lip
Measures against abnormality	Measures against abnormality (when tube air pressure leaks)	△: Difficulty in maintaining proper position △: Leakage due to insufficient pressure of contacting surface	○: Proper position can be maintained △: Leakage prevention expected as contacting surface has sufficient pressure	○: Proper position can be maintained △: Leakage prevention expected as contacting surface has sufficient pressure	○: Proper position can be maintained △: Leakage prevention expected as contacting surface has sufficient pressure
Total evaluation		△	○	×	×
					○: Good △: Poor ×: Low feasibility

6. Implementation details of this project

6.2. Implementation details

2) Development of Element Technology for Retrieval Device Installation

(1) Development of Element Technology for Work Cells

b. Work cell sealing method (such as welding, inflate sealing, or water sealing)

[2] Installation procedure of seal on actual equipment

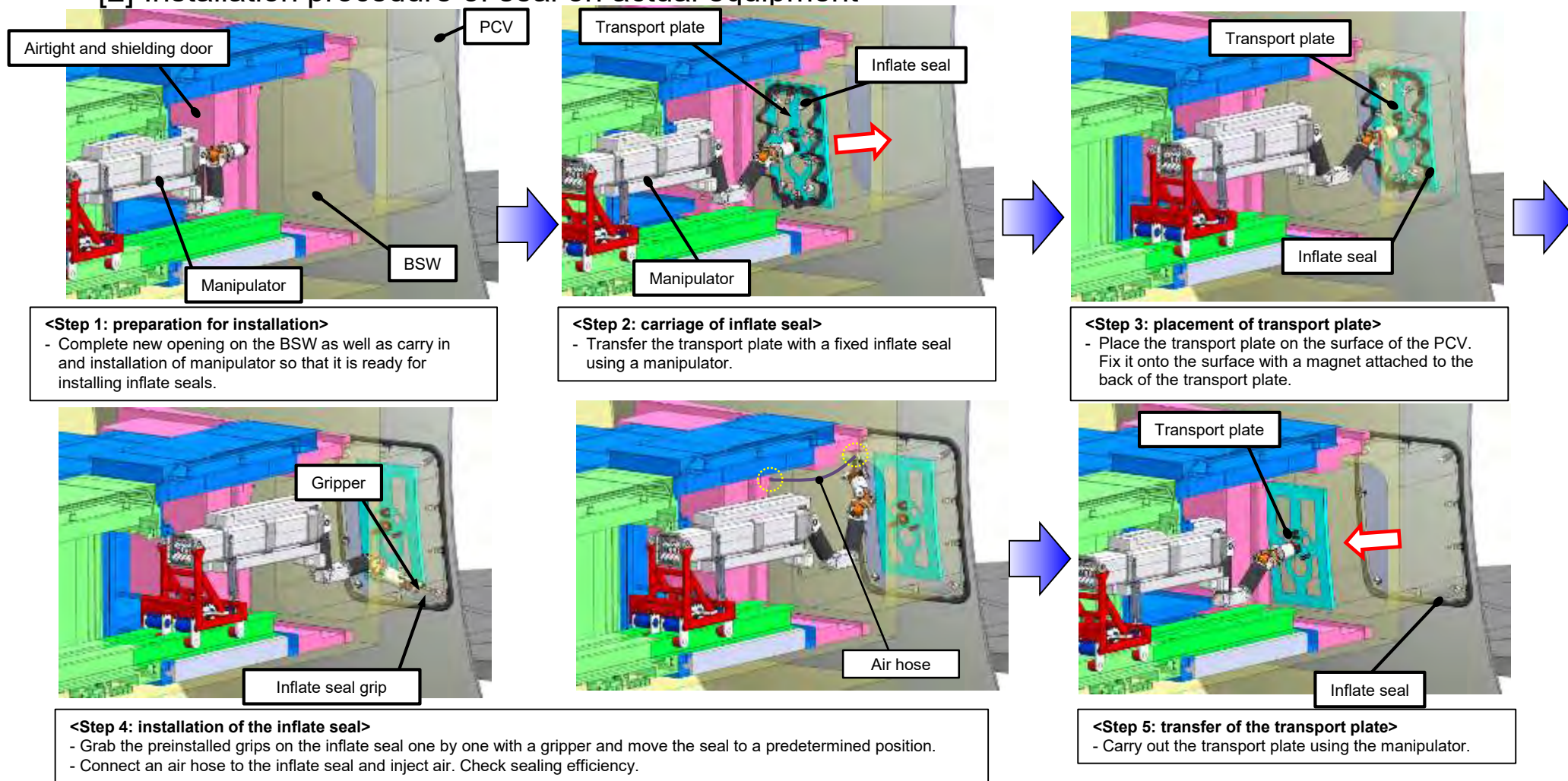

6. Implementation details of this project

6.2. Implementation details

2) Development of Element Technology for Retrieval Device Installation

(1) Development of Element Technology for Work Cells

b. Work cell sealing method (such as welding, inflate sealing, or water sealing)

[2] Installation procedure of seal on actual equipment

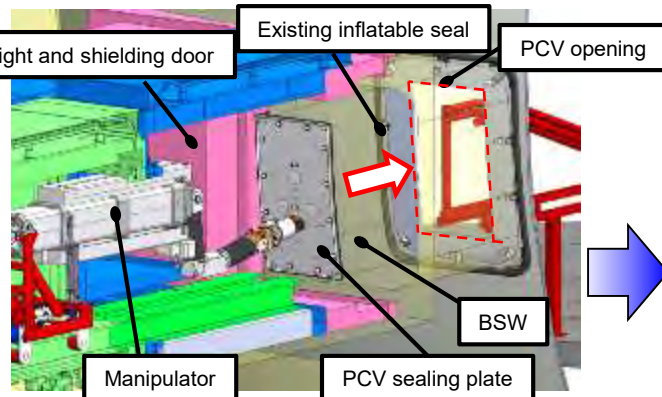

<Step 1: carry in of PCV sealing plate>
- Transfer a PCV sealing plate with a manipulator.

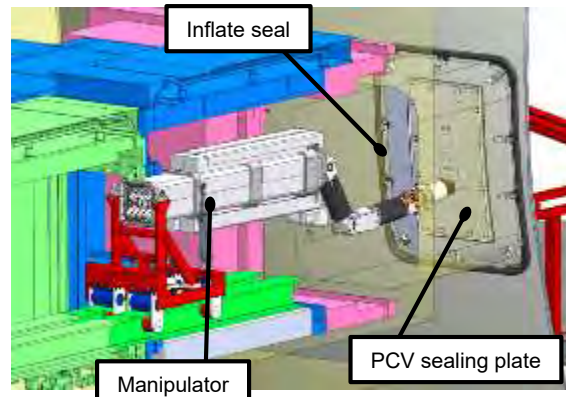

<Step 2: fixing of PCV sealing plate>
- Install the PCV sealing plate on the opening of the PCV.
- Start the cylinder of the sealing structure, fix the PCV and sealing structure, and seal the PCV opening.

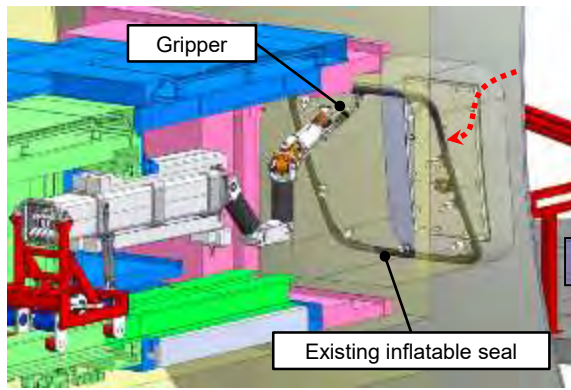
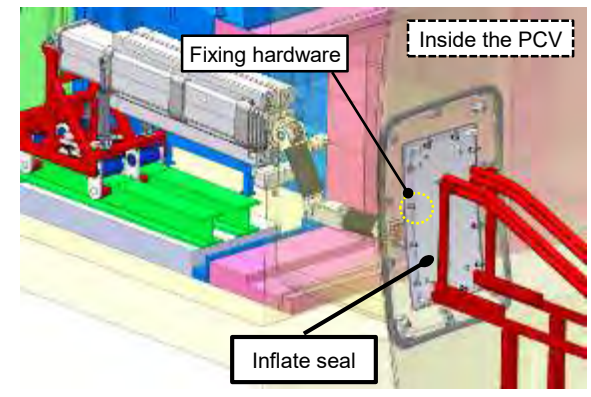

<Step 3-1: preparation for installation>
- Take off and remove the existing inflate seal from the specified position.

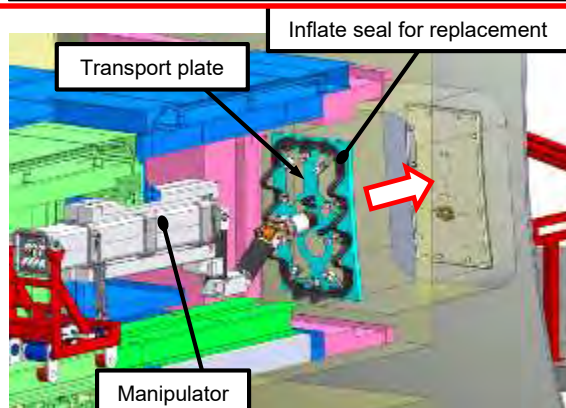

<Step 3-2: transfer of inflate seal>
- Transfer the transport plate with the fixed inflate seal using a manipulator.

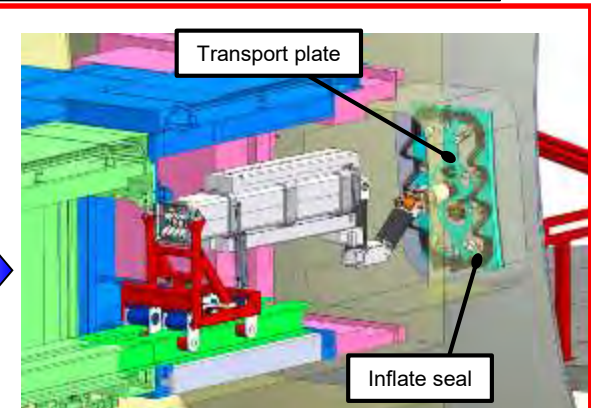

<Step 4: installation of transport plate>
- Fix the transport plate on to the PCV sealing plate with a magnet attached to the back.

6. Implementation details of this project

6.2. Implementation details

2) Development of Element Technology for Retrieval Device Installation

(1) Development of Element Technology for Work Cells

b. Work cell sealing method (such as welding, inflate sealing, or water sealing)

[2] Installation procedure of seal on actual equipment

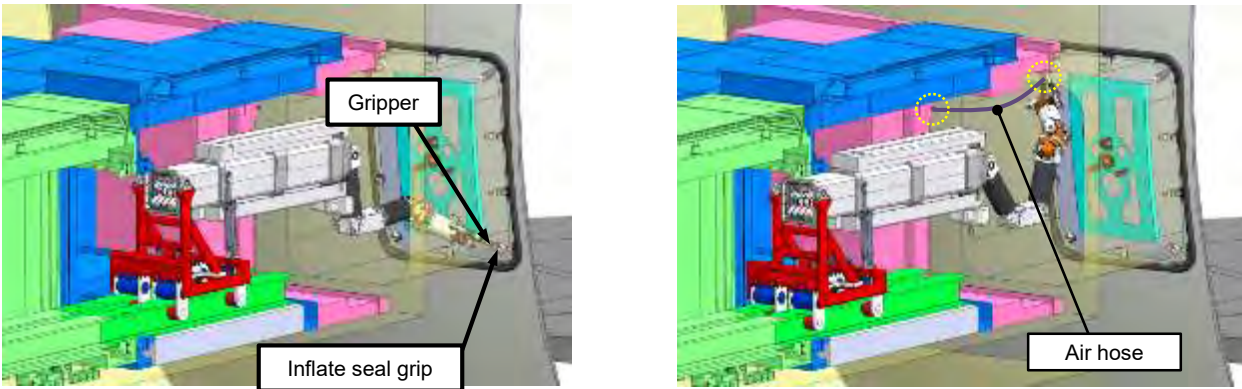

<Step 5: installation of inflate seal>
- Grab the preinstalled grips on the inflate seal one by one with a gripper and move the seal to a predetermined position.
- Connect an air hose to the inflate seal and inject air.

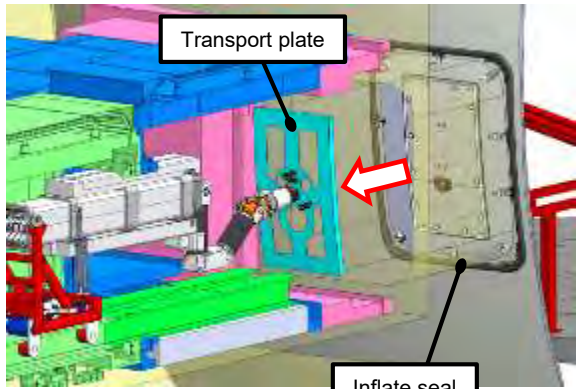

<Step 6: transfer of transport plate>
- Transfer the transport plate outside the PCV using the manipulator.

Same procedure as transfer and installation of inflate seal

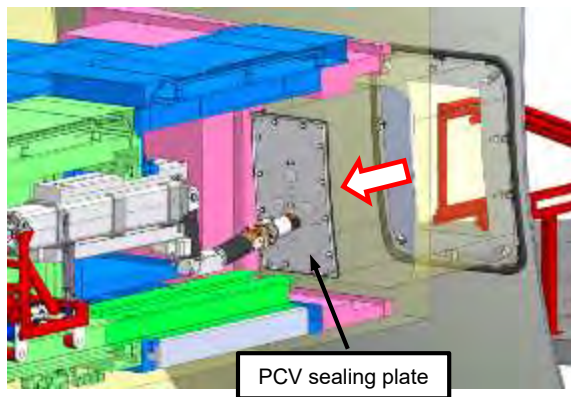

<Step 7: transfer of PCV sealing plate>
- Transfer the PCV sealing plate outside the PCV using the manipulator.

6. Implementation details of this project

6.2. Implementation details

2) Development of Element Technology for Retrieval Device Installation

(1) Development of Element Technology for Work Cells

b. Work cell sealing method (such as welding, inflate sealing, or water sealing)

[3] Identification of basic required specifications of seals

i) Basic requirements

- Confinement of radioactive materials by establishing a boundary
- Required conditions of seals (target value)
 - Amount of leakage shall be 40 m³/h or less* when the differential pressure is -100 Pa.
 - The seal must be sound when the designed differential pressure is 500 Pa.
 - Abnormality in seals shall be detectable.
 - The negative pressure (differential pressure during normal operation) in the primary boundary shall be maintained during maintenance.
- * The air flow rate of the gas control system shall be 3,000 m³/h, of which 1,000 m³/h are assumed to be used for recirculation, another 1,000 m³/h for ventilation inside the cell, and the remaining 1,000 m³/h for maintaining the negative pressure of the boundary. The amount of leakage was specified according to the surface area ratio of PCV and cell plus margin.
- Dose reduction of workers
 - Method to achieve required functions: plan a complete remote-control operation
 - Required conditions of seal: enable installation and replacement of seal by remote control

ii) Environmental conditions

- Dose rate: 5 to 10 mSv/h on 1F of reactor building, 10 to 100 Sv/h near the outer wall of PCV shell
- Temperature: -7 to 40° C
- Humidity: outside the boundary similar to outside air, 99% or less inside the boundary
- Design life: 50 years (However, wear-and-tear items shall be replaceable during maintenance.)
- Maximum gap width between the BSW and PCV is 50 mm (nominal value: 44 mm (+6 mm/-0 mm))
- BSW and PCV are spherical (SR = 10 m)
- The sum of relative displacement caused by heat expansion or earthquake is assumed to be ±5 mm
- Weld line that is 3 mm in height and 20 mm in width is expected on the outer surface of the PCV

6. Implementation details of this project

6.2. Implementation details

2) Development of Element Technology for Retrieval Device Installation

(1) Development of Element Technology for Work Cells

b. Work cell sealing method (such as welding, inflate sealing, or water sealing)

[4] Identification of confirmation items regarding seals

- ◆ Qualifying conditions of unit test: Applicability of inflate seal as a boundary is regarded by element tests on sealing efficiency.
- ◆ Qualifying conditions of combination test: Feasibility of remote control replacement is verified by inflate seal remote control replacement test.

Legend:

◎: Intended result was obtained

Phase	Purposes of tests (Test items)	Unit test	Combination test	Notes
1) Preparation before installation of seal				
Surface treatment on installation surface	Data on methods for removing irregular solid objects from the gap between the BSW and PCV as well as removing burrs and warps of BSW mold by remote operation is obtained.	—	◎	Conducted manually
Caulking	Fill the gap between the BSW mold and concrete with caulking and obtain data for remote operation.	—	◎	Conducted manually
2) Installation of seal				
Installation and replacement of inflate seal	Inflate seals can be transported, installed, and replaced by remote operation using a drywell manipulator.	—	◎	Gap width [mm] Nominal value: 50 to 44 Test range: 54 to 39 Insertable range Manual: 54 to 39 Remote control: 54 to 44
	Visually check that the inflate seal is inserted inside the gap between the BSW and PCV and is installed in the correct position of the BSW opening without twists, etc.	—	◎	
	The seal can be confirmed after installation on whether it achieves the target performance.	—	◎	
3) Sealing efficiency				
Sealing efficiency during normal operation	The seal functions on curved surfaces with weld reinforcement and bumps on mold and without guide grooves.	◎	◎	Leakage standard < 40 m ³
Sealing efficiency when pressure provided to the seal is lost	Seal maintains its sealing efficiency with its elasticity without internal pressure.	◎	◎	Leakage standard < 40 m ³

6. Implementation details of this project

6.2. Implementation details

2) Development of Element Technology for Retrieval Device Installation

(1) Development of Element Technology for Work Cells

b. Work cell sealing method (such as welding, inflate sealing, or water sealing)

[5] Conditions of test (verification test for sealing efficiency)

Test conditions

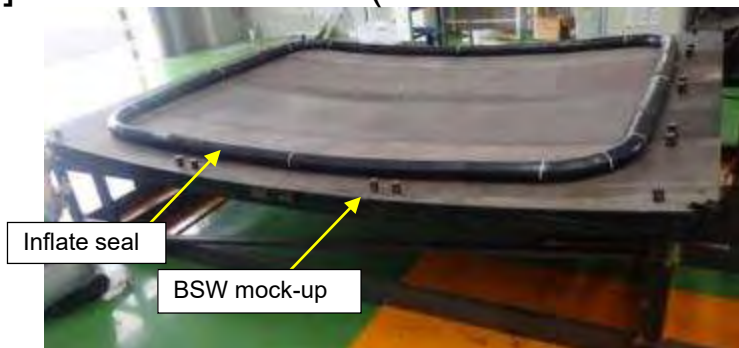

	Specification value	Variable	Abuse test
Pressure inside the PCV	-100 Pa (g)	Up to 300 Pa (g) (positive pressure)	up to 500 Pa (g)
Pressure inside seal	0.08MPa	0 to 0.1 MPa	0 MPa (loss of internal pressure)
Gap between the PCV and RSW	44mm	44 to 50 mm (nominal)	55mm
Plate joints	—	Weld reinforcement : 3 mm Joint level difference: 2 mm	—

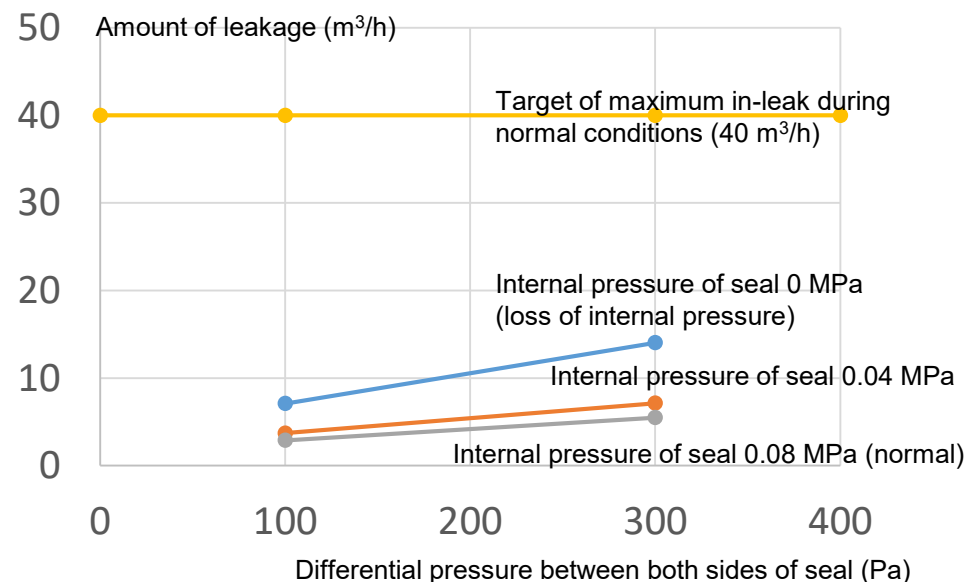
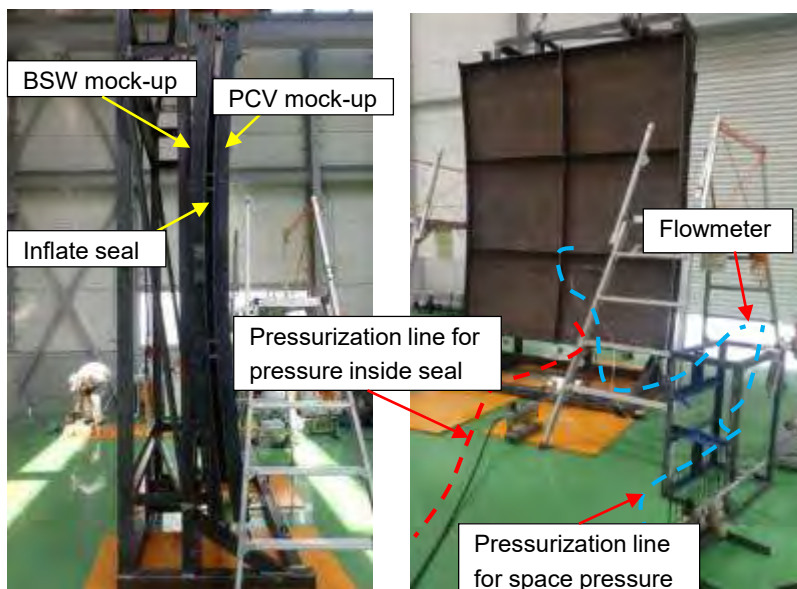

Amount of leakage versus differential pressure between both sides of seal (no grease)

6. Implementation details of this project

6.2. Implementation details

2) Development of Element Technology for Retrieval Device Installation

(1) Development of Element Technology for Work Cells

b. Work cell sealing method (such as welding, inflate sealing, or water sealing)

[5] Conditions of test (change in shape of seal during installation)

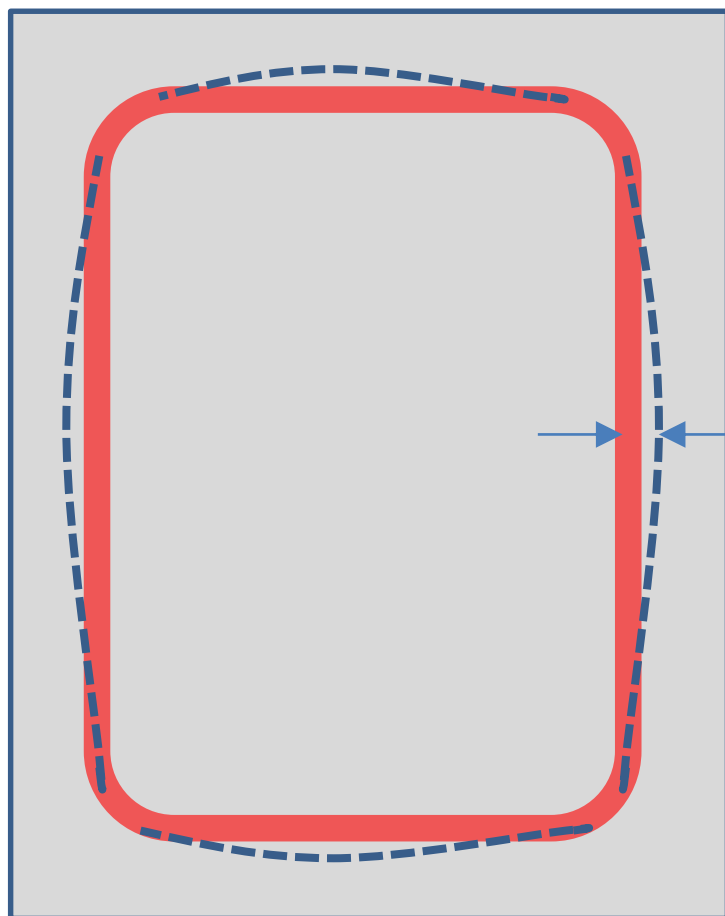

When fixing the seal, its shape before internal pressure is applied (red solid line) and after internal pressure (0.08 MPa) is applied (blue dotted line) differs. The seal expands into a barrel-like shape.

It expands a maximum of 7 mm.

After it expands, its shape will not change as it is in contact with the PCV wall and BSW.

Tests are conducted on an expanded seal.

Maximum expansion: 7 mm

6. Implementation details of this project

6.2. Implementation details

2) Development of Element Technology for Retrieval Device Installation

(1) Development of Element Technology for Work Cells

b. Work cell sealing method (such as welding, inflate sealing, or water sealing)

[5] Conditions of test (observation of discontinuous seals [welded area, joints])

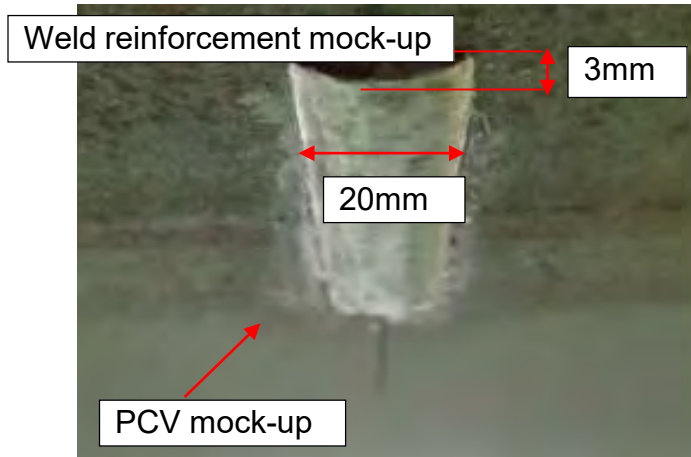

(a) Weld reinforcement mock-up

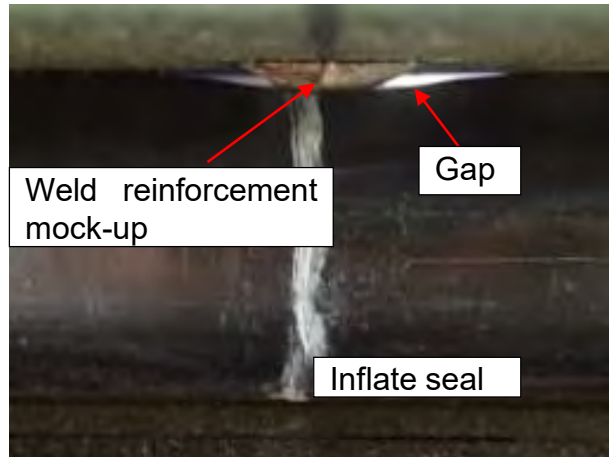

(b) Internal pressure of seal 0 MPa



(c) Internal pressure of seal 0.08 MPa



(d) Center level difference of joint of BSW mold (2 mm)



(e) Seal on joint of BSW mold



(f) Leaking foam

6. Implementation details of this project

6.2. Implementation details

2) Development of Element Technology for Retrieval Device Installation

(1) Development of Element Technology for Work Cells

b. Work cell sealing method (such as welding, inflate sealing, or water sealing)

[5] Conditions of test (effect of silicone grease on discontinuous seals)

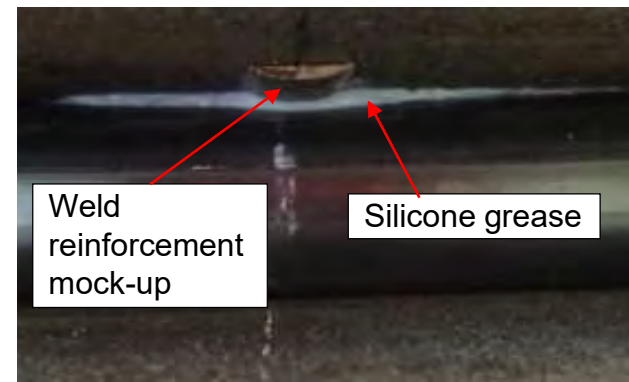
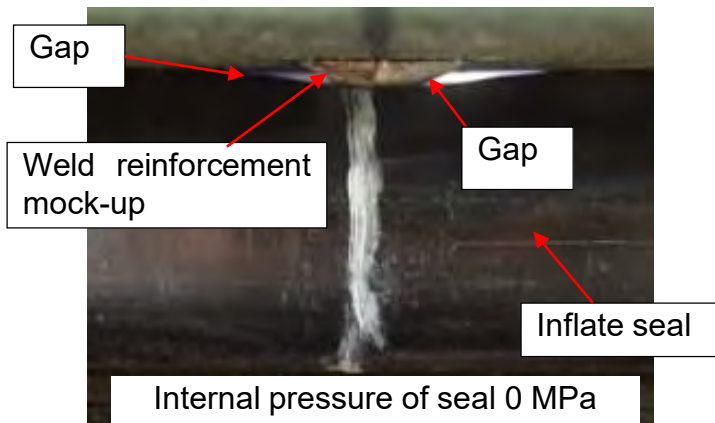

After application of grease

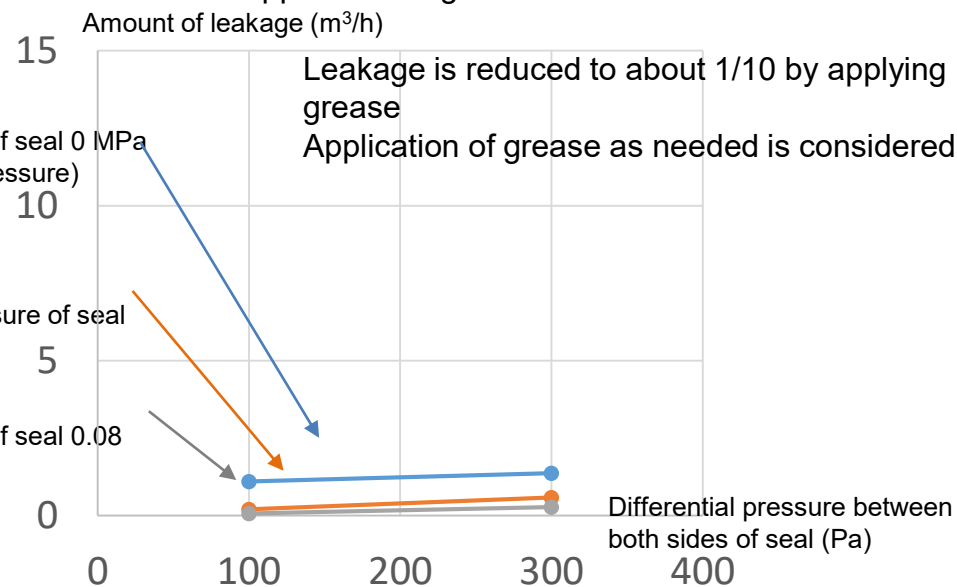
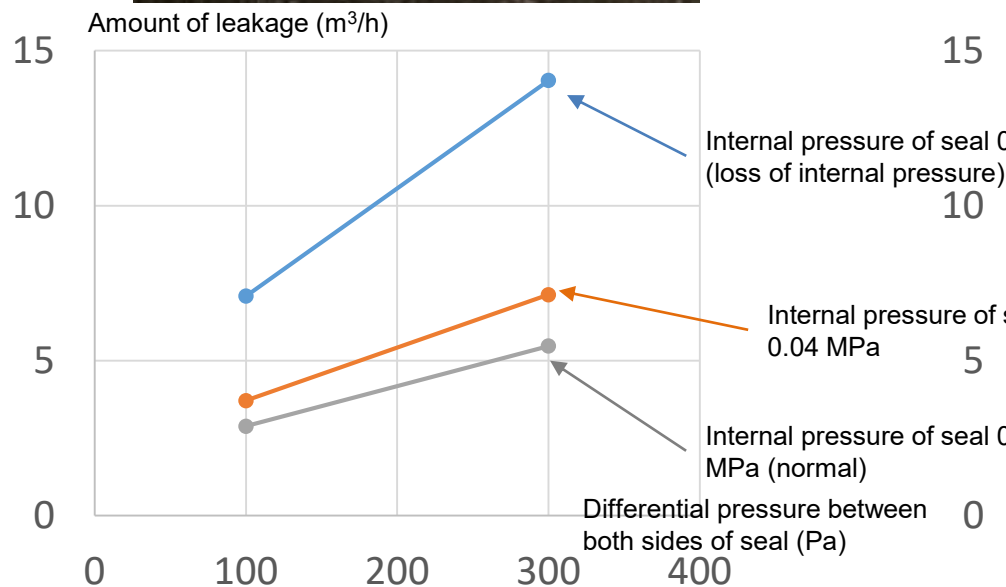

6. Implementation details of this project

No.164

6.2. Implementation details

2) Development of Element Technology for Retrieval Device Installation

(1) Development of Element Technology for Work Cells

b. Work cell sealing method (such as welding, inflate sealing, or water sealing)

[6] Degree of simulation of actual equipment in combination test (configuration of test device)

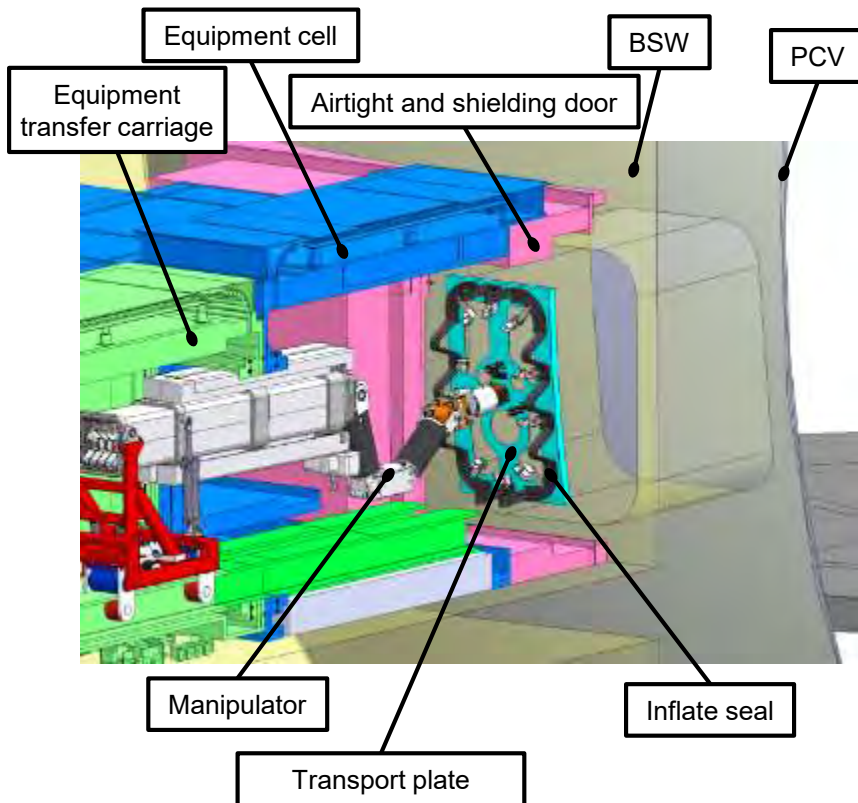

Configuration of actual equipment*

* The actual equipment may change depending on the results of the combination test and in step with future design progress.

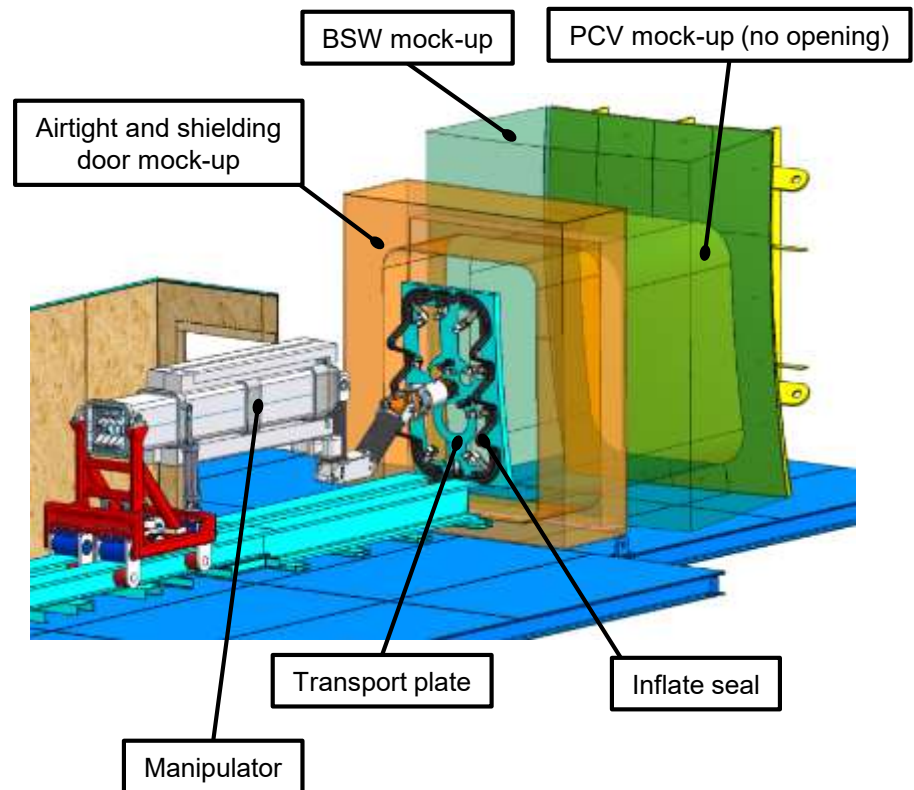

Equipment configuration in the combination test

6. Implementation details of this project

No.165

6.2. Implementation details

2) Development of Element Technology for Retrieval Device Installation

(1) Development of Element Technology for Work Cells

b. Work cell sealing method (such as welding, inflate sealing, or water sealing)

[6] Degree of simulation of actual equipment in combination tests (test device system)

		Element test (Combination test)	Actual operation at the site	Notes (differences between the mock-up and actual site)
Seal material	Cross-section shape	Diamond cross-section	Diamond cross-section	—
	Material/molding method	EPDM/die molding	EPDM/die molding	—
	Size/shape	Actual size/square	Actual size/square	—
	Connector for manipulator	Yes	Yes	—
Gap between PCV and BSW	PCV wall/BSW mold surface	Carbon steel plate	Carbon steel plate	—
	Curved surface	Spherical surface (R = 10 m)	Spherical surface (R = 10 m)	—
	Gap width	Nominal value 44 mm	Nominal value 44 mm	—
BSW opening		Yes	Yes	—
Manipulator		Yes	Yes	Structure and drive shaft are simulated
Shielding door		Present (no shielding and airtight function)	Present (with shielding and airtight function)	Simulating the dimensions of the opening Thickness is 150 mm less than that of the actual reactor
Sealing lid for test		Yes	None	Because the mock-up for the test has no shielding door with an airtight function, the sealing lid is closed and the sealing efficiency is verified.
Equipment cell, equipment transfer carriage		None	Yes	—
Transport plate		Yes	Yes	—
PCV sealing plate		Present (Shape simulated)	Yes	Shape that will interfere replacement of inflate seal was mimicked
Seal air hose connection		General-use coupling	Remote control coupling	Air hose is connected manually in the test

6. Implementation details of this project

6.2. Implementation details

2) Development of Element Technology for Retrieval Device Installation

(1) Development of Element Technology for Work Cells

b. Work cell sealing method (such as welding, inflate sealing, or water sealing)

[7] Procedure of seal installation test in combination tests

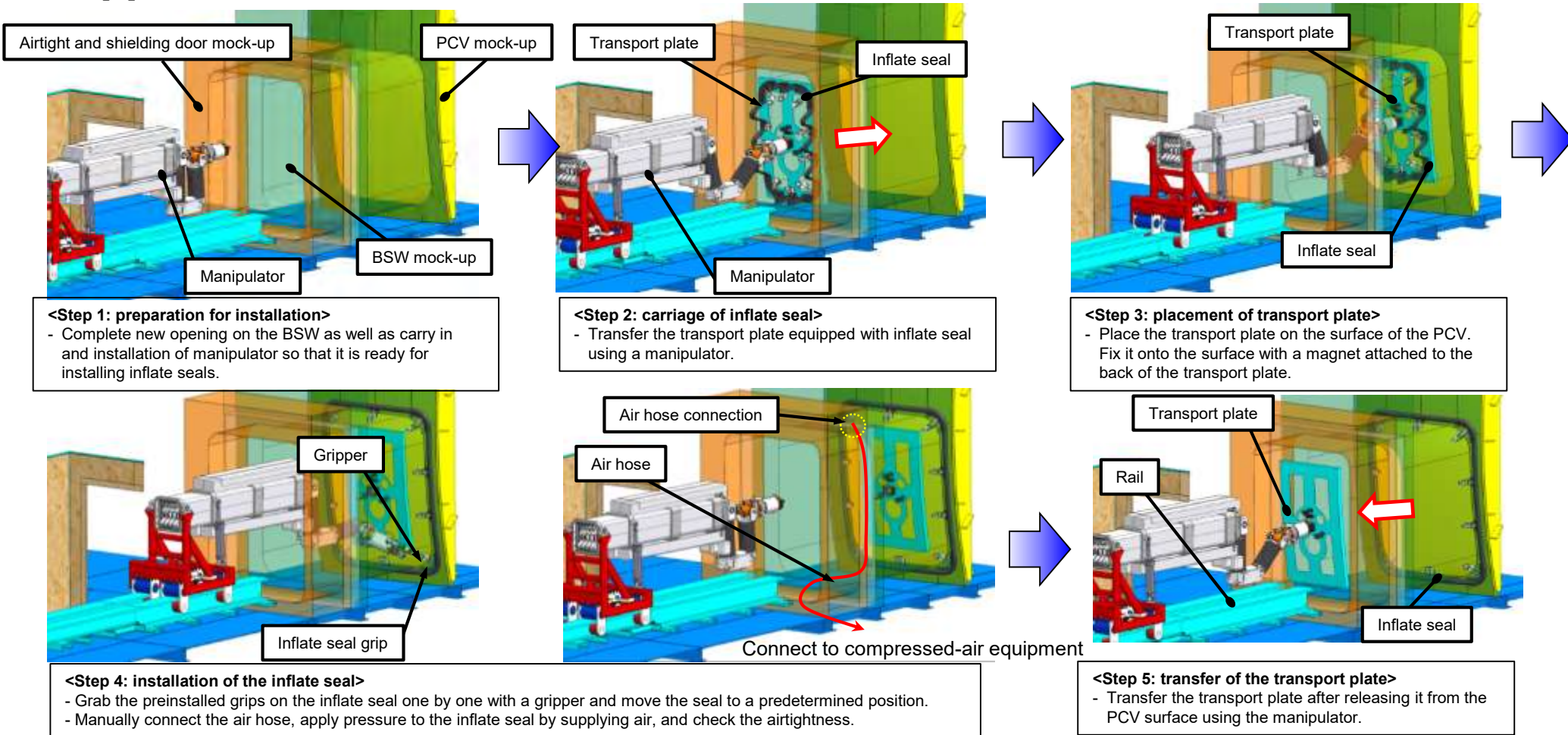

6. Implementation details of this project

6.2. Implementation details

2) Development of Element Technology for Retrieval Device Installation

(1) Development of Element Technology for Work Cells

b. Work cell sealing method (such as welding, inflate sealing, or water sealing)

[7] Procedure of seal installation test in combination tests (when replacing seals)

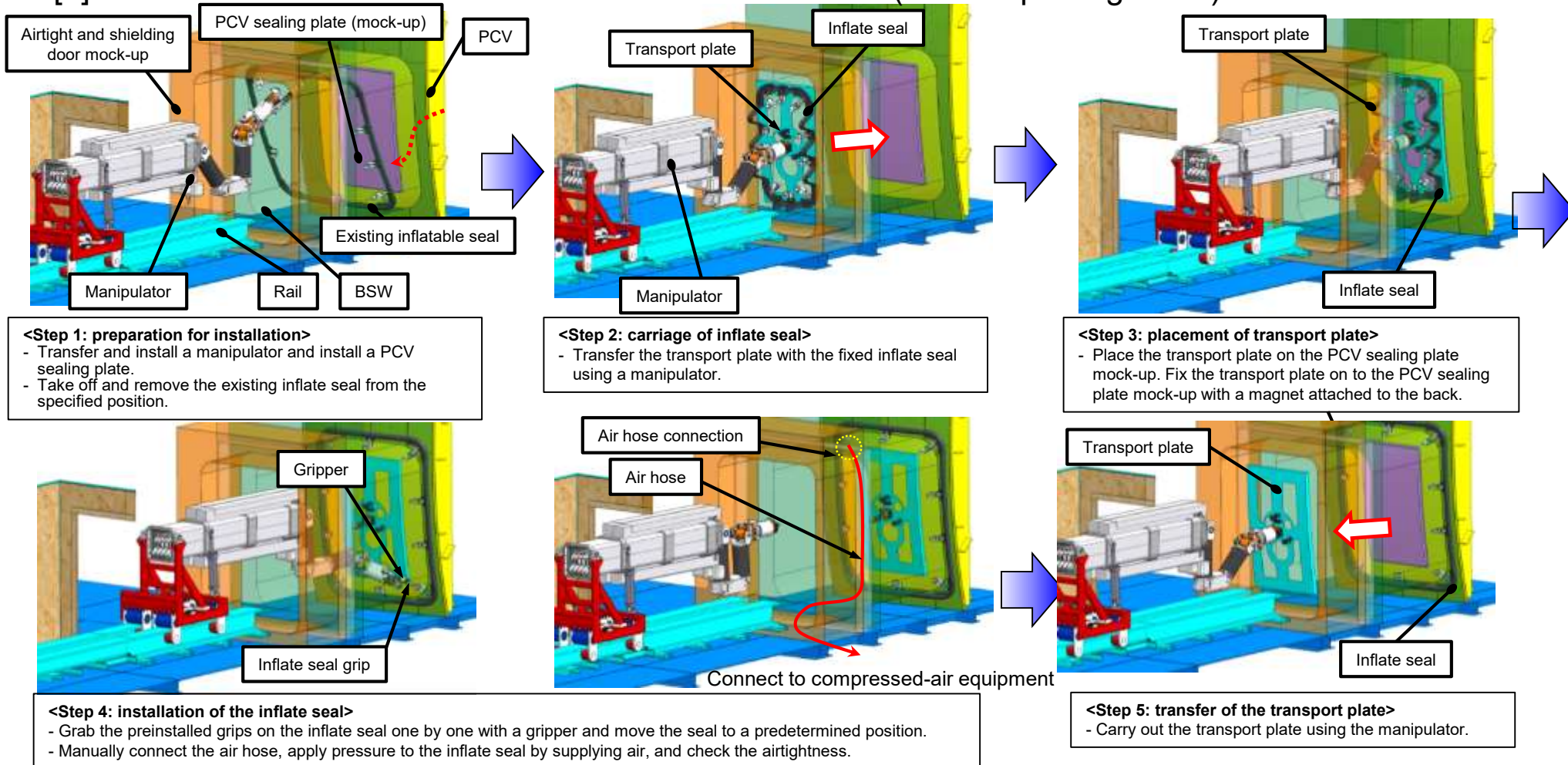

6. Implementation details of this project

No.168

6.2. Implementation details

2) Development of Element Technology for Retrieval Device Installation

(1) Development of Element Technology for Work Cells

b. Work cell sealing method (such as welding, inflate sealing, or water sealing)

[8] Results of combination test

i) Evaluation of seal test (sealing efficiency test)

Test conditions

No.	Item	Value/condition
1	Space pressure	300 Pa or greater (300 to 330)
2	Pressure inside seal	0MPa, 0.08MPa
3	Gap between PCV and BSW	Nominal value: 44 to 50 mm Actual measurement: 39 to 54 mm
4	Installation of seal	Remote control, manual
5	Surface condition	Cleaned with flap wheel Irregular solid objects removed
6	Joint of BSW mold	Level difference filled with caulk (test also conducted before application of caulk)
7	Uneven part of the BSW mold	Level difference filled with caulk (test also conducted before application of caulk)
8	PCV weld line	Two weld lines with height of 3 mm and width of 20 mm are present above and below
9	Inflate seal surface	Silicone grease applied (tests also conducted before application of silicone grease)

Shielding door mock-up

BSW mock-up

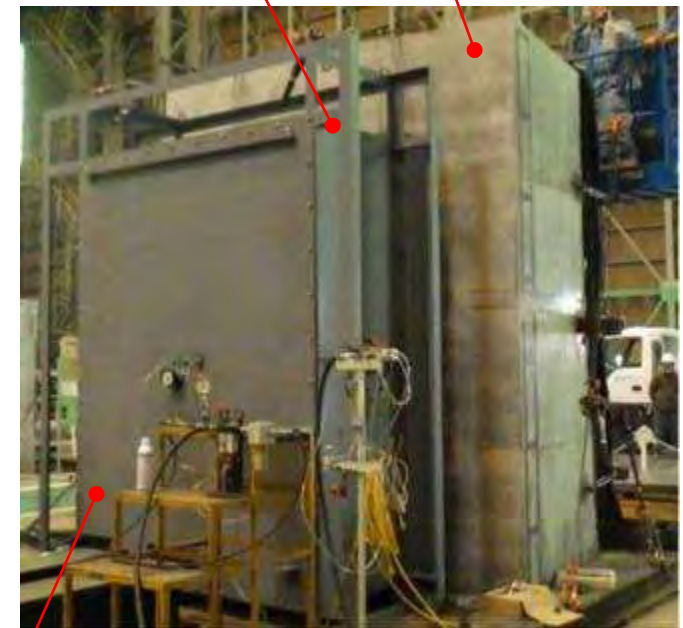

Sealing lid

6. Implementation details of this project

No.169

6.2. Implementation details

2) Development of Element Technology for Retrieval Device Installation

(1) Development of Element Technology for Work Cells

b. Work cell sealing method (such as welding, inflate sealing, or water sealing)

[8] Results of combination test

ii) Evaluation of installation and replacement task: carry-in/out of transport plate

- It was confirmed that the transport plate can be transferred from the equipment cell to the PCV and installed on the PCV by remote control using a drywell manipulator.
- It was confirmed that the transport plate on the PCV can be connected to the manipulator and transferred to the equipment cell by remote control.
- Task procedures were established and arm position data was obtained which are both necessary for the above task.
- It was made clear the cameras and lighting arrangement required remote control transfer.

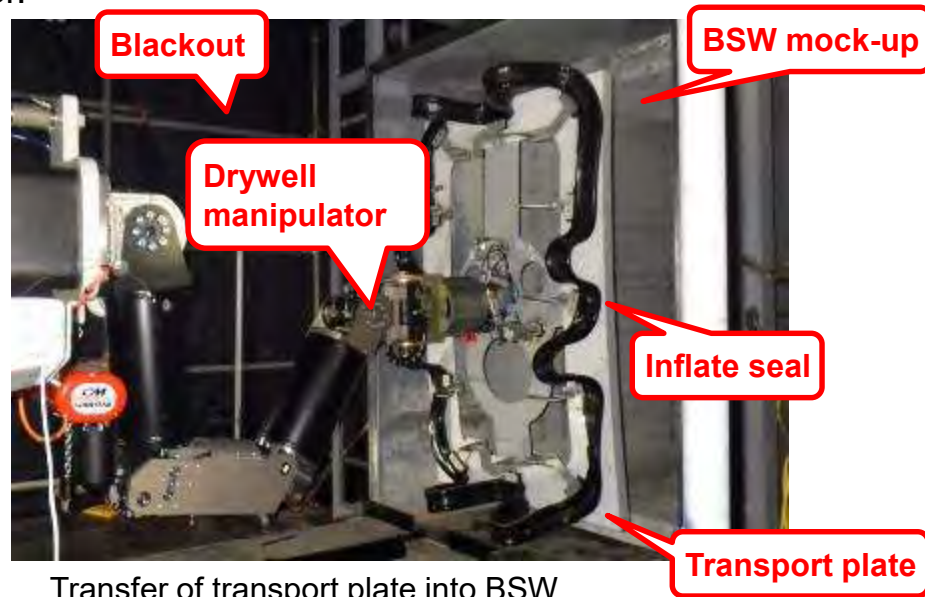

Transfer of transport plate into BSW

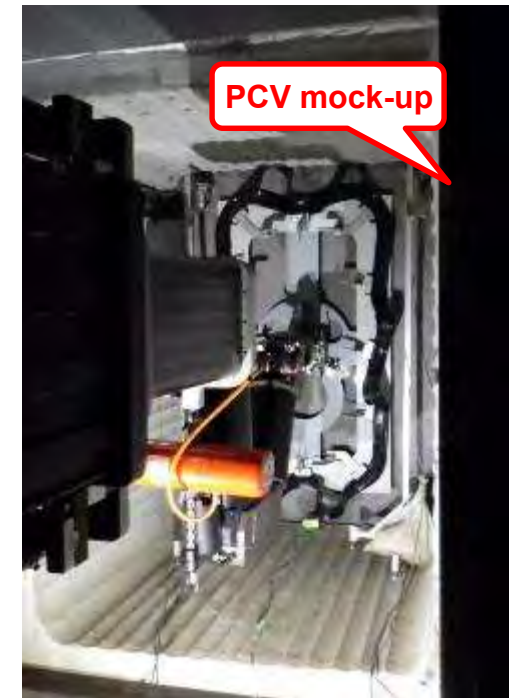

Installation of transport plate on PCV

6. Implementation details of this project

No.170

6.2. Implementation details

2) Development of Element Technology for Retrieval Device Installation

(1) Development of Element Technology for Work Cells

b. Work cell sealing method (such as welding, inflate sealing, or water sealing)

[8] Results of combination test

ii) Evaluation of installation and replacement task: carry-in/out of transport plate

- It was confirmed that inflate seals can be inserted by remote control in gaps between the BSW and PCV if the gaps are within the design scope. Measures must be taken such as using insertion jigs in places where the gaps are narrow due to the unevenness of the BSW mold that occur when creating an opening on the BSW.
- It was confirmed that proper installation of the inflate seal can be confirmed visually by camera.



Temporary storage of
inflate seal on PCV



Insertion of inflate seal
between gap



Area for remote control installation



Completion of inflate seal installation

6. Implementation details of this project

6.2. Implementation details

2) Development of Element Technology for Retrieval Device Installation

(1) Development of Element Technology for Work Cells

b. Work cell sealing method (such as welding, inflate sealing, or water sealing)

[8] Results of combination test

ii) Evaluation of installation and replacement task: carry-in/out of transport plate

- Confirmation items and work procedure that enable the installation of inflate seals were established.
- The arm position data in each step was obtained and a reproduceable procedure was developed.

Step No.	Target	Confirmation items	Movement	Arm position data								
				Cart	Tilt	Shoulder Rotate	Shoulder Pivot	Elbow 1	Elbow 2	Wrist Pitch	Wrist Yaw	Wrist Rotate
1	TC	All the TC magnets are attached to the PCV	Grabbing	2.54	-0	0.19	-32.7	66.57	50.69	-88.9	0.02	135.3
			Installation	2.61	-0	0.187	-25.4	64.67	47.19	-88	0.02	135.3
2	LT	LC magnet is attached to the PCV	Grabbing	2.63	-0	40.78	-42.5	71.04	57.78	-87.9	0	135.7
			Installation	2.61	-0	56.67	-29.5	65.59	48.43	-78.3	-1.4	118
3	TL	All the TL magnets are attached to the PCV	Grabbing	2.6	-0	20.91	-48.5	87.22	54.5	-87.2	3.06	142.7
			Installation	2.6	-0	48.33	-32.8	87.33	34.67	-85	3.06	120.3
4	BC	All the BC magnets are attached to the PCV	Grabbing	2.74	-0	180.5	-23.5	66.94	35.14	-72.9	-0.1	90.48
			Installation	2.7	-0	174.9	-15.5	58.92	35.1	-73	-0	134.6
5	LB	LB magnet is attached to the PCV	Grabbing	2.79	-0	158.6	-44.7	71.34	54.45	-72.2	8.2	134.6
			Installation	2.7	-0	156.4	-18.7	68.3	26.48	-87.1	-0.1	54.21

Procedures for temporarily storage of inflate seal

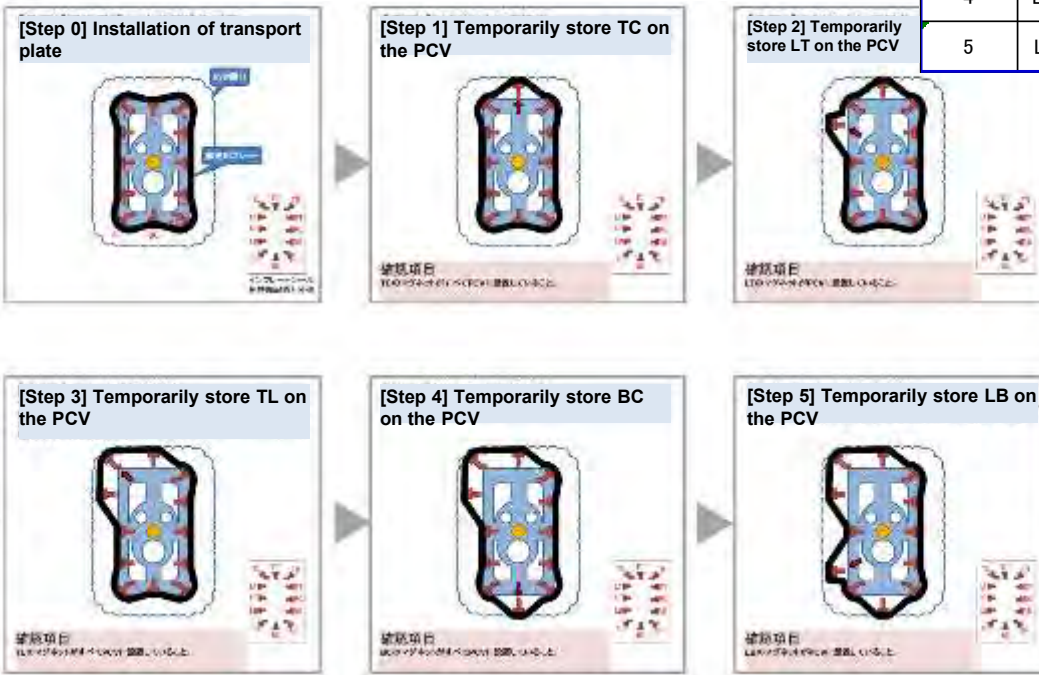

Referential value of arm position data for each step

Temporary storage of inflate seal on PCV
Example of detailed procedure and confirmation items

6. Implementation details of this project

No.172

6.2. Implementation details

2) Development of Element Technology for Retrieval Device Installation

(1) Development of Element Technology for Work Cells

b. Work cell sealing method (such as welding, inflate sealing, or water sealing)

[8] Results of combination test

ii) Evaluation of installation and replacement task: carry-in/out of transport plate

- The optimum camera and lighting arrangement data was obtained by a series of remote control operations using the testing facility that simulates the environment the actual equipment is in.

(The diagram below is an example of the arrangement during installation of an inflate seal.)

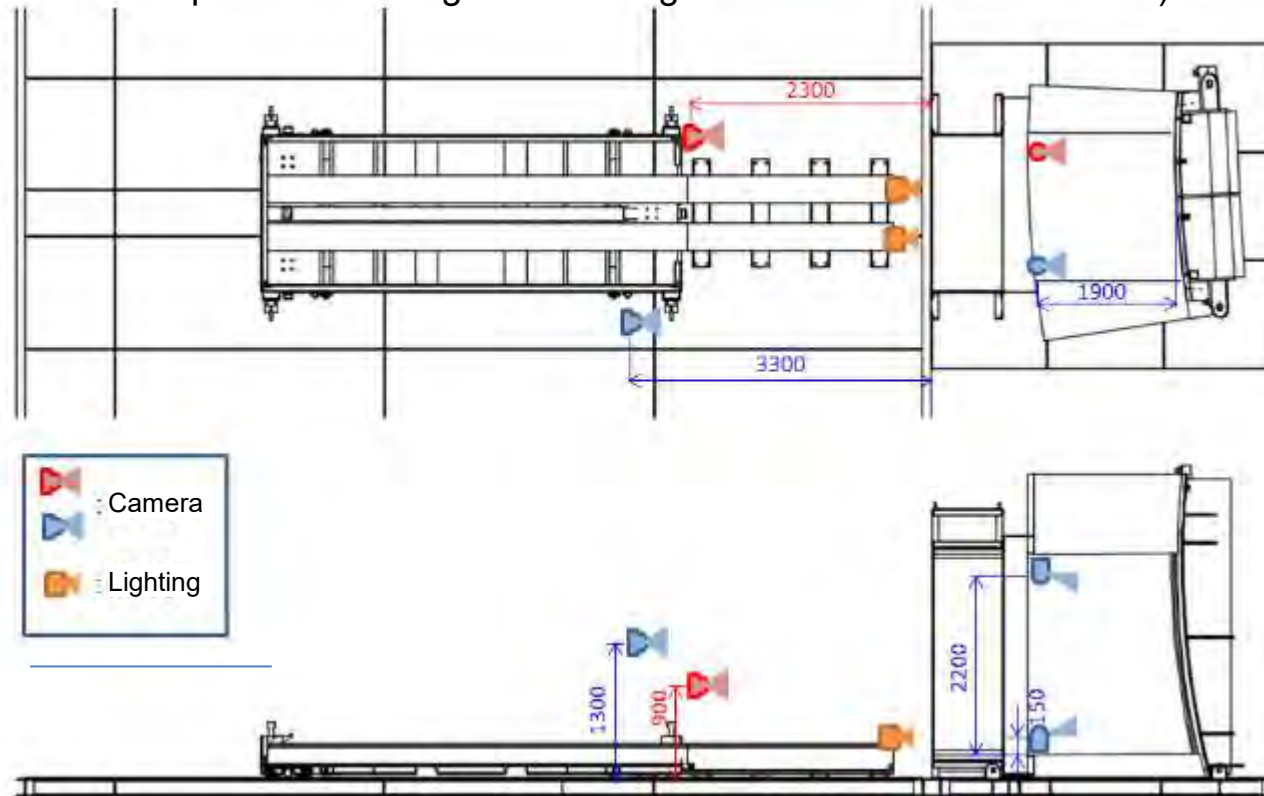

6. Implementation details of this project

6.2. Implementation details

2) Development of Element Technology for Retrieval Device Installation

(1) Development of Element Technology for Work Cells

b. Work cell sealing method (such as welding, inflate sealing, or water sealing)

[8] Results of combination test

iii) Sealing efficiency test of seals installed by remote control

- The basic performance was verified by unit element tests. It was confirmed that when installed by remote control, the seal delivered the performance equivalent to that in the unit element tests.
- Conditions including application of caulk (whether to apply it or not), insertion of seal (manual or remote control), and inflate seal pressure were changed (eight cases).
- The seal which was installed by remote control had similar sealing efficiency to that observed in the unit element test and satisfied the qualifying standard of 40 [m³/h].

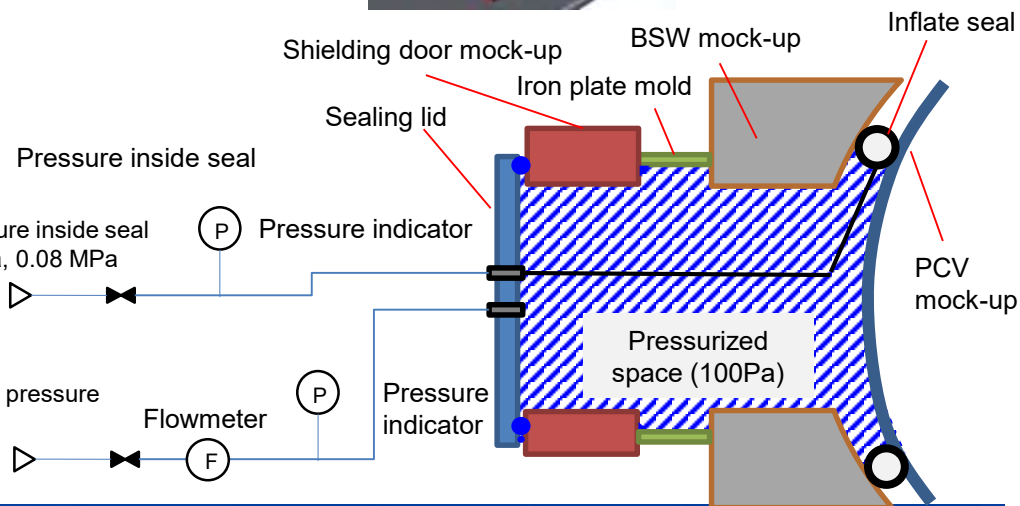
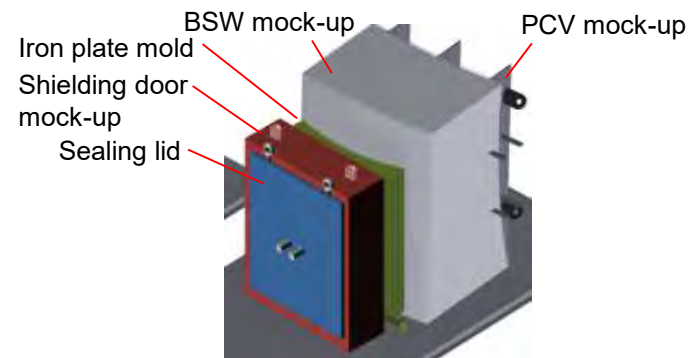
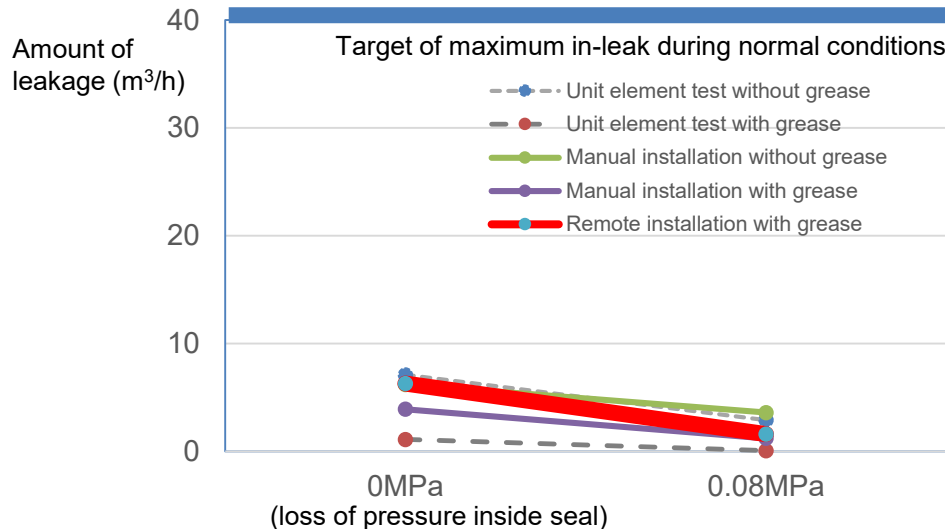

- [Procedure]
1. Increase pressure inside the inflate seal (pressurization).
 2. Install a sealing lid and increase the pressure inside the pressurized space up to the test pressure (100 Pa).
 3. Maintain the pressure inside the space at 100 Pa and measure the amount of air supplied. The flow rate shall be the amount of leakage from the inflate seal.
 4. Confirm leakages from sealing lid, shielding door mock-up, and iron plate mold before opening on the BSW.

6. Implementation details of this project

No.174

6.2. Implementation details

2) Development of Element Technology for Retrieval Device Installation

(1) Development of Element Technology for Work Cells

b. Work cell sealing method (such as welding, inflate sealing, or water sealing)

[8] Results of combination test

iv) Acquisition of data for installation pretreatment

(1) Removal of burr

The burr on the BSW mold was removed manually by using an air-driven rotating grinding tool.

The edge of the mold was smoothed out by placing the tool on the burr and going over it several times at different angles.

(the tool was moved approx. 100 mm in 7 seconds)

[Issues and measures]

Development of burr removal tool. Ability to slide along and follow the shape of the target area.

The tool is held upright in the finishing touches so that no burr is left on the side closer to the seal.



Step 1. Tilt the tool and run it across the edge three times



Step 2. Lay the tool and run it across the edge once



Step 3. Hold the tool upright and run it across the edge twice

6. Implementation details of this project

No.175

6.2. Implementation details

2) Development of Element Technology for Retrieval Device Installation

(1) Development of Element Technology for Work Cells

b. Work cell sealing method (such as welding, inflate sealing, or water sealing)

[8] Results of combination test

iv) Acquisition of data for installation pretreatment

(2) Gap cleaning: The gap between the BSW and PCV was cleaned manually using an air-driven flap wheel tool. Approx. a width of 10 to 20 mm can be cleaned per stroke. The tool was inserted 10 mm further after every stroke and the procedure was repeated about 15 times to clean the gap up to 150 mm in width.

[Feedback] The tool used has a flap wheel of approx. 25 mm in length on the tip and can clean a 10 to 20 mm-wide area. If a longer tip is used, a wider area can be cleaned and would likely reduce the number of strokes needed.

[Issues and measures] Development of gap cleaning tool



Flap wheel



Insert approx. 10 mm deeper after one stroke



Insert approx. 10 mm deeper after one stroke

6. Implementation details of this project

No.176

6.2. Implementation details

2) Development of Element Technology for Retrieval Device Installation

(1) Development of Element Technology for Work Cells

b. Work cell sealing method (such as welding, inflate sealing, or water sealing)

[8] Results of combination test

iv) Acquisition of data for installation pretreatment

(3) Caulk on uneven BSW mold

Caulk was applied manually on uneven parts and joints of the BSW mold.

[Issues and measures] - Selection of caulk material with consideration of radiation resistance

- Development of caulking tool
- Development of tool for monitoring gap between the BSW and PCV

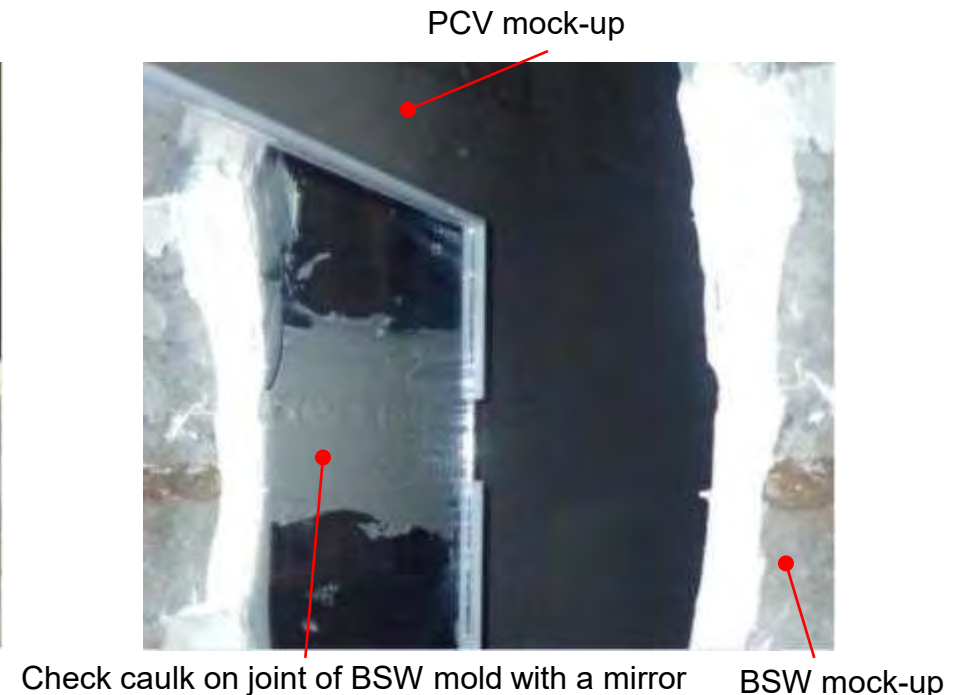
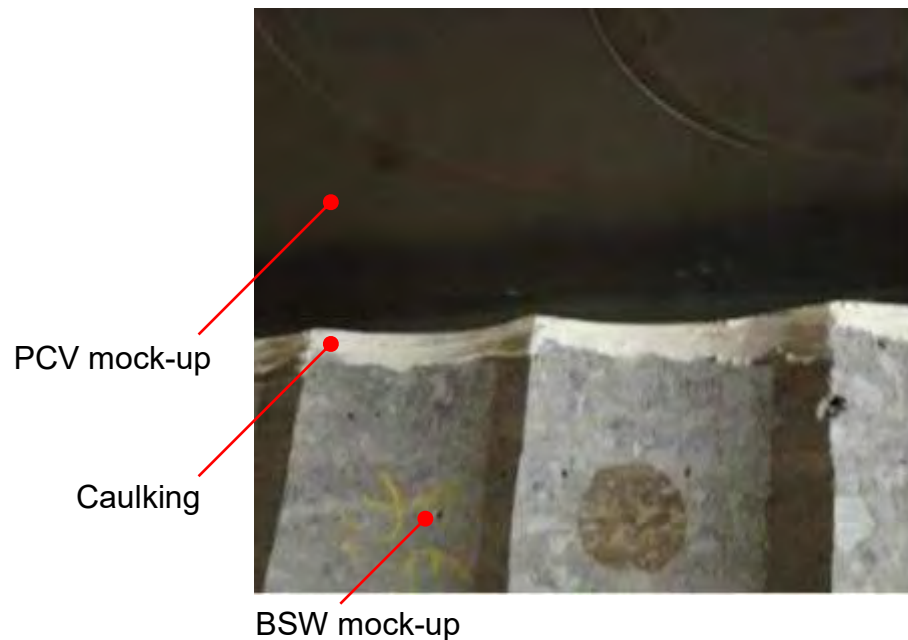

6. Implementation details of this project

No.177

6.2. Implementation details

2) Development of Element Technology for Retrieval Device Installation

(1) Development of Element Technology for Work Cells

b. Work cell sealing method (such as welding, inflate sealing, or water sealing)

[9] Test equipment (inflate seal)

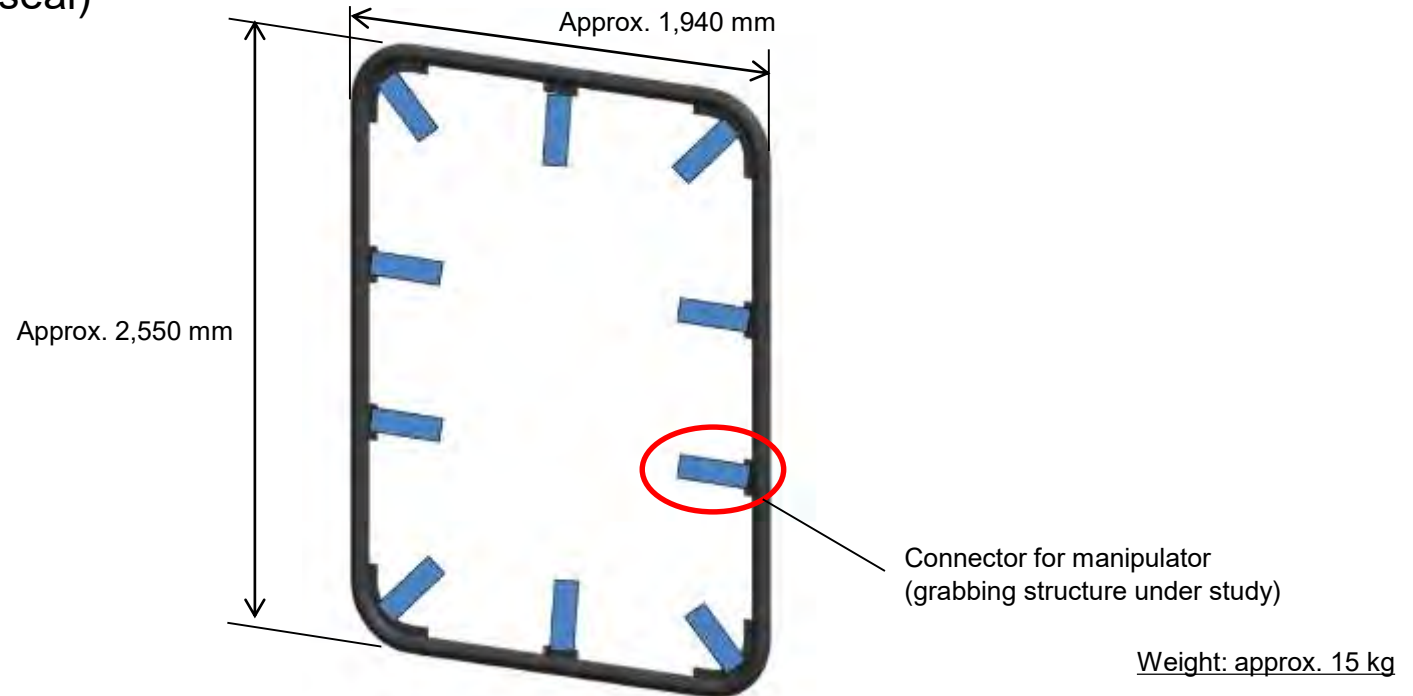

	Element test (Combination test)	Actual operation at the site	Degree of simulation
Cross-section shape	Diamond cross-section	Diamond cross-section	About the same
Material/molding method	EPDM/die molding	EPDM/die molding	About the same
Size/shape	Actual size/rectangular	Actual size/rectangular	About the same
Connector for manipulator	Yes	Yes	About the same

6. Implementation details of this project

6.2. Implementation details

2) Development of Element Technology for Retrieval Device Installation

(1) Development of Element Technology for Work Cells

b. Work cell sealing method (such as welding, inflate sealing, or water sealing)

[9] Test equipment (manipulator)

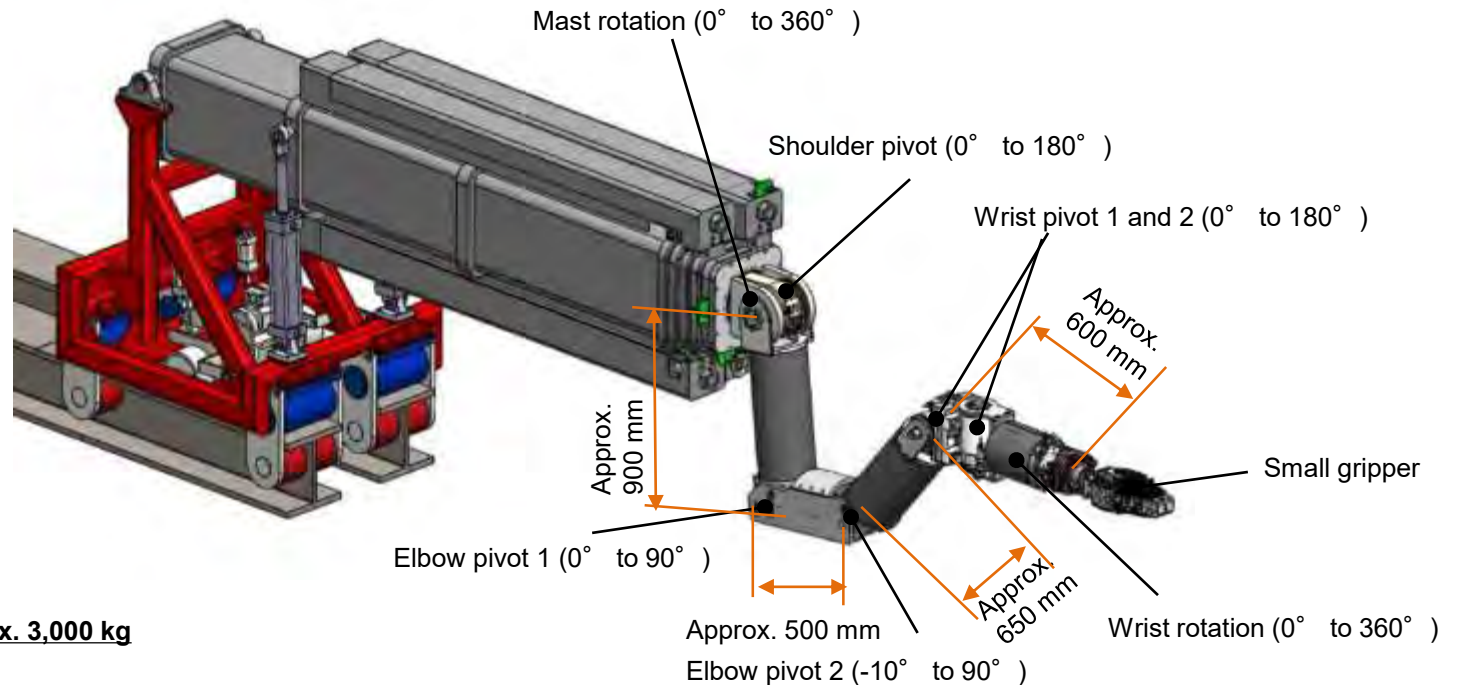

Weight: approx. 3,000 kg

	Element test (Combination test)	Actual operation at the site	Degree of simulation
Arm handling load	Approx. 100kg	Approx. 100kg	About the same
Number of operable pivots	9	9	About the same
Maximum reach of arm	Approx. 2,650 mm (from arm base)	Approx. 2,650 mm (from arm base)	About the same
Arm driving method	Hydraulic drive	Hydraulic drive	About the same
Driving method	Travel on rail	Travel on rail	About the same

6. Implementation details of this project

6.2. Implementation details

2) Development of Element Technology for Retrieval Device Installation

(1) Development of Element Technology for Work Cells

b. Work cell sealing method (such as welding, inflate sealing, or water sealing)

[9] Test equipment (PCV mock-up, BSW mock-up, airtight shielding door mock-up)

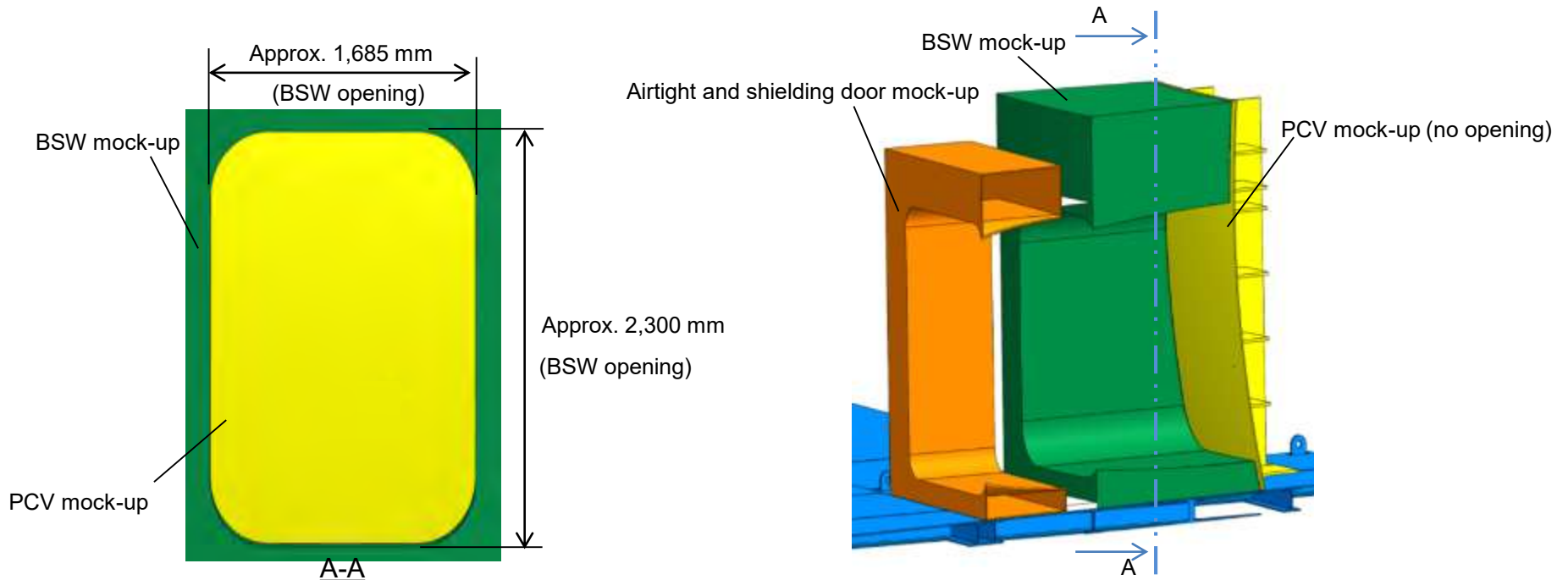

		Element test (Combination test)	Actual operation at the site	Degree of simulation
Gap between PCV and BSW	PCV wall/BSW mold surface	Carbon steel plate	Carbon steel plate	About the same
	Curved surface	Spherical surface (R = 10 m)	Spherical surface (R = 10 m)	About the same
	Gap width	44mm	44mm	About the same
BSW opening		Yes	Yes	About the same
Shielding door		Yes	Yes	Simulating the dimensions of the opening Thickness is 150 mm less than that of the actual reactor

6. Implementation details of this project

6.2. Implementation details

2) Development of Element Technology for Retrieval Device Installation

(1) Development of Element Technology for Work Cells

b. Work cell sealing method (such as welding, inflate sealing, or water sealing)

[9] Test equipment (transport plate)

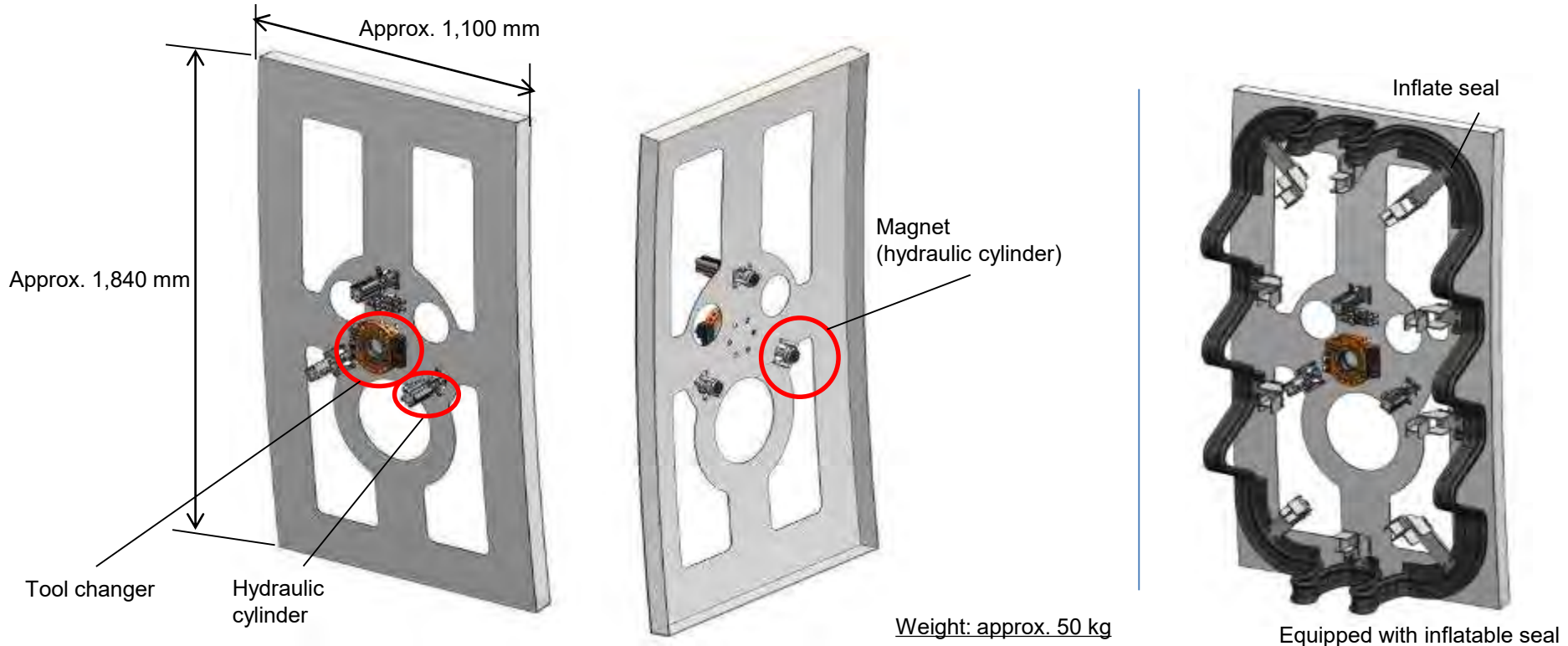

	Element test (Combination test)	Actual operation at the site	Degree of simulation
Main material	Carbon steel	Carbon steel	About the same
Size/shape	Approx. W1,100 mm × H1,840 mm/rectangular	Approx. W1,100 mm × H1,840 mm/rectangular	About the same
Connection with manipulator	Tool changer	Tool changer	About the same
Fixing on PCV	Magnet	Magnet	About the same

6. Implementation details of this project

6.2. Implementation details

2) Development of Element Technology for Retrieval Device Installation

(1) Development of Element Technology for Work Cells

b. Work cell sealing method (such as welding, inflate sealing, or water sealing)

[10] Exposure assessment: level-specific criteria (contents of safety requirements)

Cited from materials of *Upgrading of Approach and Systems for Retrieval of Fuel Debris and Internal Structures*

			Defense in depth levels			Supplementary information	
General safety rules	Safety requirements	Level 1	Level 2	Level 3			
Protection of public community	Confinement of radioactive materials	Prevention of leakage that exceeds the allowable level specified in the safety standards for radioactive materials in gas	0.1 mSv/year	0.1 mSv/event	5 mSv/event	—	
		Prevention of leakage that exceeds the allowable level specified in the safety standards for liquid radioactive materials				—	
		Prevention of leakage of radioactive materials caused by transport casks				—	
	Prevention of additional formation of radioactive materials	Prevention of the abnormal generation of radioactive materials caused by nuclear reaction				In level 3, coordinate with the confinement of radioactive materials and achieve judgement criteria	
		Prevention of the emission of radioactive materials due to abnormal temperature rise in fuel debris					
		Prevention of abnormal diffusion of radioactive materials caused by cutting fuel debris and structures					
Prevention of excessive radiation exposure	Installation of shields for preventing direct radiation exposure in excessive amounts	—					
Protection of workers	Prevention of excessive external and internal exposure of workers	Development of appropriate design for installation of shields as well as configurations for classification of contamination and dose, in addition to designs for a system for remote maintenance and traffic line setting to reduce exposure	Dose limit is 100 mSv/5 years, 50 mSv/year	10 mSv/event	100 mSv/event		—
		Development of operation methods, maintenance plans, and an operation management system for dose reduction of workers					—
Prevention of hazards that may threaten the safety function	Items that shall be considered in design and design conditions	Maintenance of conditions under which a fire will not break out by the reaction of metal dust and oxygen	Prevention of fire	Prevention of fire	Prevention of fire	—	
		Maintenance of the concentration of flammable gas to a level equal to or below the flammability limit so as to prevent fire and explosions	Prevention of fire	Prevention of fire	Prevention of fire	—	
Monitoring of plant state		Monitoring of the plant to keep track of its state	—	—	—	—	

- ① Regarding the general safety rule “Prevention of additional formation of radioactive materials (level 3),” coordinate with the general safety rule “Confinement of radioactive materials (level 3)” and achieve the judgement criteria (judged from the viewpoint of low decay heat levels and impact of exposure due to occurrence of criticality)
- ② If the boundary is damaged due to metal dusts or fire caused by flammable gas, it is believed to cause great impact of exposure, thus the judgement criteria is to prevent the occurrence of such event in levels 1 to 3.

6. Implementation details of this project

No.182

6.2. Implementation details

2) Development of Element Technology for Retrieval Device Installation

(1) Development of Element Technology for Work Cells

b. Work cell sealing method (such as welding, inflate sealing, or water sealing)

[10] Exposure assessment: action policy for levels 2 and 3

Level classification	Equivalent opening area	Grounds for the conditions	Flow rate Differential pressure 100 Pa	Detection method	Event prevention measures	Recovery from event
Level 1	10 cm ² or less	Opening area that achieves flow rate of 40 m ³ /h with differential pressure of 100 Pa	40m ³ /h	<ul style="list-style-type: none"> Monitor gap with camera (backlight installed on the outside of the sealed area) Supply smoke to the outside of the sealed area and detect radiation from the inside Monitor the position of the seal grabbing section with a camera Observe changes in the inner pressure of the seal Accumulate data by conducting material tests on replaced seal materials 		<ul style="list-style-type: none"> Observe deterioration of seal material and gap so that no abnormality occurs Inspect and replace seal regularly
Level 2	100 cm ² or less	10 times greater than that of Level 1 (equivalent to opening with seal width 50 mm × length 200 mm)	446m ³ /h	<ul style="list-style-type: none"> Monitor gap with camera 	<ul style="list-style-type: none"> Observe deterioration of seal material and gap so that no abnormality occurs Inspect and replace seal regularly 	<ul style="list-style-type: none"> Grasp conditions of abnormal parts by investigation Determine and implement measures such as reinstallation, partial replacement, and total replacement and restore the condition
Level 3	4500cm ²	When there is no seal (seal width 50 mm × entire circumference 9,000 mm)	20044m ³ /h	<ul style="list-style-type: none"> Observe presence of seal with camera 	<ul style="list-style-type: none"> Grasp conditions of abnormal parts by investigation Determine and implement measures such as reinstallation, partial replacement, and total replacement and restore the condition 	<ul style="list-style-type: none"> Investigate and grasp conditions of abnormal events and parts Determine and implement measures such as reinstallation, partial replacement, and total replacement and restore the condition

6. Implementation details of this project

6.2. Implementation details

2) Development of Element Technology for Retrieval Device Installation

(1) Development of Element Technology for Work Cells

b. Work cell sealing method (such as welding, inflate sealing, or water sealing)

[10] Exposure assessment: action policy for levels 2 and 3

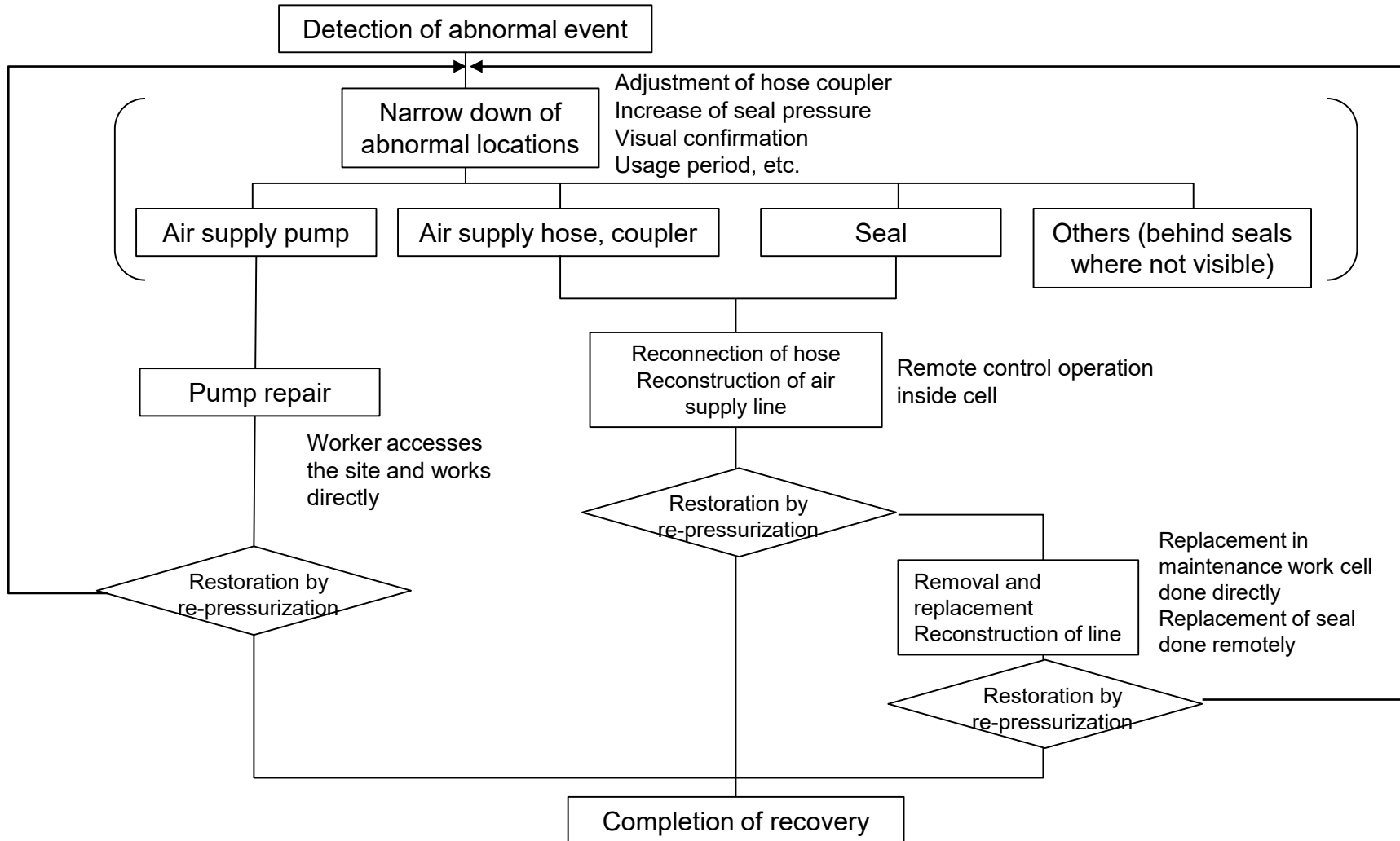

6. Implementation details of this project

No.184

6.2. Implementation details

2) Development of Element Technology for Retrieval Device Installation

(1) Development of Element Technology for Work Cells

b. Work cell sealing method (such as welding, inflate sealing, or water sealing)

[11] Test summary

Verification item	Data	Notes
1) Preparation before installation of seal		
Surface treatment on installation surface	Basic data on coating with manipulator was obtained.	Manual operation
Caulking	Basic data on application of caulk with manipulator was obtained.	Manual operation
2) Installation of seal		
Common items	<ul style="list-style-type: none"> - Transfer, installation, and replacement of seal were enabled by drywell manipulator and bird's eye camera used in this project. - Data on cameras and lighting arrangement required for remote control operation was obtained. 	Reduction of operation time requires familiarization of operators.
Transfer of transport plate	<ul style="list-style-type: none"> - Transport plate can be transferred and installed on the PCV wall by remote operation. 	Estimated time on actual equipment: 3h
Installation of seal	<ul style="list-style-type: none"> - Inflate seal can be installed between the BSW and PCV by remote operation. - The arm work procedures and confirmation items were determined and arm position data in each step was obtained. 	Estimated time on actual equipment: 42h Measures for insertion of seal in narrow gaps are required for the actual equipment.
Removal of seal	<ul style="list-style-type: none"> - Inflate seal can be removed and transferred to the equipment cell by remote control. 	Estimated time on actual equipment: 4h
Transport plate	<ul style="list-style-type: none"> - It was confirmed that the transport plate can be transferred to the equipment cell by remote control. 	Estimated time on actual equipment: 3.5h
Installation position and twist	<ul style="list-style-type: none"> - Installation position and twists in the inflate seal can be visually confirmed with a camera. 	
3) Sealing efficiency test results		
Seal leakage test	The amount of leakage from a remotely installed seal satisfied the qualifying standard of 40 m ³ /h. Pressure of normal use (0.08 MPa): 1.5 m ³ /h Loss of supplied pressure (0 MPa): 6.3 m ³ /h	

6. Implementation details of this project

No.185

6.2. Implementation details

2) Development of Element Technology for Retrieval Device Installation

(1) Development of Element Technology for Work Cells

b. Work cell sealing method (such as welding, inflate sealing, or water sealing)

[11] Test summary

- Outcomes of this project
 - The amount of leakage from a remotely installed seal satisfied the qualifying standard of 40 m³/h.
 - Pressure of normal use (0.08 MPa): 1.5 m³/h
 - Loss of supplied pressure (0 MPa): 6.3 m³/h
 - It was confirmed that the series of remote operations concerning handling of transport plate and seal is possible.
 - The arm work procedures and confirmation items concerned with the installation and removal of the seal were determined and arm position data in each step was obtained.
 - It was confirmed that transfer, installation, and replacement of seal were enabled by the drywell manipulator and the bird's eye camera used in this project. Data on cameras and lighting arrangement required for remote control operation was obtained.
- Issues (to be addressed in the design phase of devices and equipment for actual construction at the site)

	Issues	Action policy
1	Reduction of installation time (42 hours in test)	Workers require proficiency training
2	Measures when gap is significantly narrower (wider) than expected (design value)	Design a seal that can be used for narrow (wide) gaps
3	Insertion of seal in narrow gaps	Adopt inserting jigs, etc.

6. Implementation details of this project

6.2. Implementation details

1) Development of Technology for Prevention of Fuel Debris Spreading

(1) Development of Fuel Debris Collection System

(2) Development of Fuel Debris Cutting / Dust Collection System

(3) Development of Prevention Method of Fuel Debris Spreading

2) Development of Element Technology for Retrieval Device Installation

(1) Development of Element Technology for Work Cells

(2) Development of Interference Object Removal during Fuel Debris Retrieval

3) Development of Remote Maintenance Technology for Fuel Debris Retrieval Device

6. Implementation details of this project

6.2. Implementation details

2) Development of Element Technology for Retrieval Device Installation

(2) Development of Interference Object Removal during Fuel Debris Retrieval

In order to retrieve fuel debris, access routes (top access and side access routes) are under development to gain access to fuel debris for its retrieval, and each route involves their own interfering objects that obstruct the retrieval work. Basically, remote operation is required to dismantle, remove, collect, and move out those objects regardless of the access route. Therefore, the development of remote technologies is implemented along with element tests with the aim of realizing the series of the said operations. The following interfering objects need to be considered in the development:

- Interfering objects of the top access route: Upper PCV structures (well shield plug, PCV head, RPV head, etc.); RPV internal structures (dryer, separator, etc.)
- Interfering objects of the side access route: equipment outside the pedestal
- Interfering objects common to both the access routes: Equipment in the pedestal (CRD housing, etc.)*¹; reactor building internal structures (contaminated instrumentation ducts, high radiation piping, etc.)*²

When additional issues that make adverse effects on the construction of the access routes are identified, such as the necessity of other interference objects removal in the course of this project, necessary consideration shall be given to them and measures shall be addressed.

*1: CRD housing(s) are referred to as CRD.H(s) hereinafter. *2: Regarding the reactor building internal structures (such as contaminated instrumentation ducts and high radiation piping), measures shall be addressed to those whose removal are found necessary to carry out fuel debris retrieval.

6. Implementation details of this project

6.2. Implementation details

2) Development of Element Technology for Retrieval Device Installation

(2) Development of Interference Object Removal during Fuel Debris Retrieval

- Purpose of development
 - Demonstrating the feasibility of the method to remove interfering objects (including those which fuel debris adheres to) that need to be removed to establish access routes to fuel debris.

- Issues to be solved
 - Feasibility of remote operation
 - ✓ Removal procedures and methods
 - ✓ Measures to prevent the fall of objects during operation
 - ✓ Cable laying methods and operation monitoring methods
 - ✓ Removed objects transportation methods

 - Selection of cutting tools
 - ✓ Applicability of cutting tools
 - ✓ Dust dispersion prevention during PCV opening

6. Implementation details of this project

6.2. Implementation details

2) Development of Element Technology for Retrieval Device Installation

(2) Development of Interference Object Removal during Fuel Debris Retrieval

- Approaches to development
 - Clarification of interfering objects to be removed
 - Development of interfering objects processing methods
 - Element test plan

Select interfering objects that can be removed by either of the top or side access methods and plan element tests to demonstrate the feasibility of their removal.

 - ✓ Method to remove interfering objects by the fuel debris retrieval device designed for the top access method
(Concurrent use of the side access method shall also be considered.)
 - Method to remove the reactor bottom section (including CRD.H)
 - ✓ Method for removing interfering objects by the fuel debris retrieval device designed for the side access method
 - Method and procedure to remove interfering objects outside the pedestal (piping and supporting structures)
 - Method and procedure used to enlarge existing openings in the PVC wall for enabling the entry of arm-type devices into the PCV
 - ✓ Method to remove interfering objects by the fuel debris retrieval devices commonly designed for both the access methods
 - Method and procedure to cut and remove interfering objects in the pedestal
 - Verification of the maneuverability of a combination of a robot arm and access rail
 - Feasibility demonstration by element tests
- Expected outcome
 - Feasibility of interfering objects removal methods
 - Feasibility of the PCV opening method
 - Estimation of the operation throughput based on the operation time of individual steps

6. Implementation details of this project

6.2. Implementation details

2) Development of Element Technology for Retrieval Device Installation

(2) Development of Interference Object Removal during Fuel Debris Retrieval

The following conceptual study and elemental tests were carried out:

Note that element tests were planned, primarily aimed at the development of technologies needed for the side access method, according to the direction for the fuel debris retrieval method given by the Agency for Natural Resources and Energy of the Ministry of Economy, Trade and Industry (METI) of Japan.

Common

- Interfering objects that need to be removed to achieve fuel debris retrieval in each access method were scrutinized, and the applicability of processing methods to the identified objects was studied. In addition, a conceptual study was performed on the throughput of the interfering object removal operation.
- a. **Method to remove interfering objects by the fuel debris retrieval device designed for the top access method**
 - Based on the following information on the condition of the actual reactors of the Fukushima Daiichi NPS provided by the previous investigations, conceptual study and elemental tests were performed focusing on the removal method of interfering objects in the reactor bottom: there are difficult-to-cut objects in the reactor bottom, resulting from the melting and mixing of fuel debris in metal structures; and it was highly difficult to implement fall prevention measures for equipment in the reactor bottom, such as CRD and CRD.H, compared to other structures, since they would lose support and easily fall when they are separated from the structure of the RPV.*
 - b. **Method for removing interfering objects by the fuel debris retrieval device designed for the side access method**
 - Based on the direction of focusing on the side access method, concrete methods to remove objects that interfere the access to fuel debris in and outside the pedestal were investigated, and element tests were performed in relation to the investigations, mainly from a priority perspective.
 - c. **Method to remove interfering objects by the fuel debris retrieval devices commonly designed for both the access methods**
 - Regarding interfering objects in the pedestal, element tests were performed aimed at developing methods to remove fallen objects such as CRD.
 - Element tests were performed to evaluate the operational performance of the robot arm and access rail combined system.
 - Conceptual study was performed on the removal method that combines the top access and side access methods.

* It was decided not to rely on the soundness of the CRD supporting structures in considering removal methods and procedure according to the result of the Unit3 PCV internal investigation.

6. Implementation details of this project

6.2. Implementation details

2) Development of Element Technology for Retrieval Device Installation

(2) Development of Interference Object Removal during Fuel Debris Retrieval

Conceptual study was performed on the analytical method to estimate the throughput of the interfering objects removal operation. The result of the conceptual study will be reported together with the result of the Upgrading of Approach and Systems for Retrieval of Fuel Debris and Internal Structures project.

➤ Introduction of simplified structure models

Simple structure models are introduced to estimate a construction period to complete removal operation.

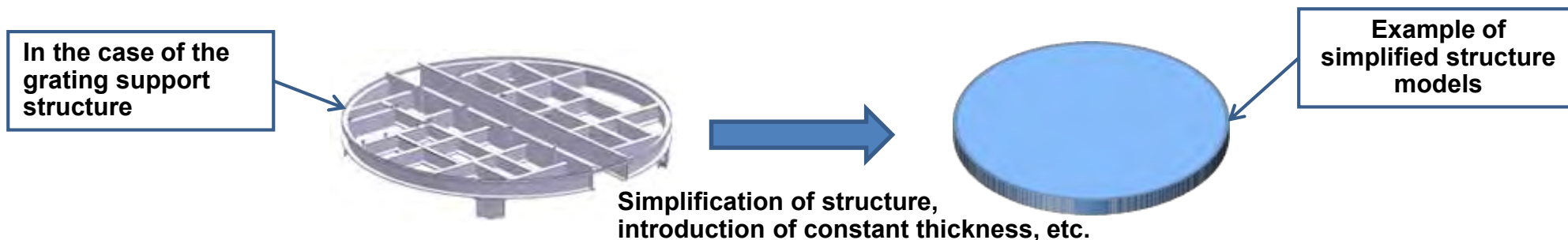

➤ Use of a fixed cutting speed for each cutting method

It was decided to use a fixed cutting speed for each cutting method to avoid variation in estimated construction period with a cutting method to be used.

Table 6.1.2-1 List of the cutting speeds of various processing methods with different thickness of the object to be

Thickness (mm)	Laser (mm/min)	Plasma arc (mm/min)	AWJ (mm/min)	Wire saw (m ² /h)
~5	3,000	900	300	0.05
6~35	250	400	70	0.05
36~150	40	60	15	0.05

The cutting speeds in the table are quoted from the report of JAEA titled, "The Selection of the Cutting Technologies for Dismantling the Fugen Reactor"

- Disc cutter cutting speed (actual measurement by IRID)
86 mm/min when cutting a metal plate with a thickness of up to 230 mm

- Wire saw cutting speed (push cutting) (actual measurement by IRID)
Cutting a reinforced concrete block with a thickness of 800 mm (30 mm/min)

6. Implementation details of this project

6.2. Implementation details



2) Development of Element Technology for Retrieval Device Installation

(2) Development of Interference Object Removal during Fuel Debris Retrieval

a. Method to remove interfering objects by the fuel debris retrieval device designed for the top access method

Interfering objects that need to be removed (including reactor internals) were listed along with relevant information.

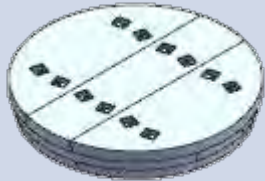
* Degree of difficulty scores in the table are based on relative evaluation

No.	Interfering objects	Outline specifications	Proposed processing methods	Examples of removal methods	Degree of difficulty of removal*	Notes
1	Shield plug 	Main material Concrete	Wire saw (push cutting), disc saw	<ol style="list-style-type: none"> ① Detach it from the reactor well, move it to a processing platform, and cut it into pieces there. ② Repeat the operation described in the paragraph 1) above, starting at the top section of the shield plug and continuing downward. 	Medium	<ul style="list-style-type: none"> · Removal methods were studied in consideration of the degree of damage and the plan of spent fuel retrieval from the SFP.
2	DSP slot plug 	Main material Concrete	Wire saw (push cutting), disc saw	<ol style="list-style-type: none"> ① Install cutting device in the DSP. ② Cut it into pieces by a wire saw (using push cutting), pull out cut pieces, put them into a container, and move them out. ③ Other methods may be used in combination to cut and remove the edge and remaining part of the plug when necessary. 	Low	<ul style="list-style-type: none"> · Mockup tests were performed in the government R&D project in FY2016.
3	PCV top head 	Main material SS	Disc saw, disc cutter, AWJ (PCV)	<ol style="list-style-type: none"> ① Cut the platform and handrails into pieces by the cutting device and remove the cut pieces. ② Cut the PCV head into blocks of a predetermined size by the cutting device and remove the cut blocks. 	Low	

6. Implementation details of this project

6.2. Implementation details



2) Development of Element Technology for Retrieval Device Installation

(2) Development of Interference Object Removal during Fuel Debris Retrieval

a. Method to remove interfering objects by the fuel debris retrieval device designed for the top access method

Interfering objects that need to be removed (including reactor internals) were listed along with relevant information.

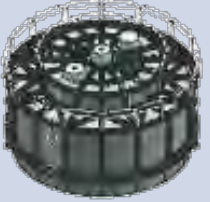
* Degree of difficulty scores in the table are based on relative evaluation

No.	Interfering objects	Outline specifications	Proposed processing methods	Examples of removal methods	Degree of difficulty of removal*	Notes
4	Reactor heat insulating material 	Main material SS	Disc saw, disc cutter, sabre saw	① Cut and separate the heat insulating material in the top section, then cut and remove the frame material. ② Cut and separate the heat insulating material in the bottom section, then cut and remove the frame material.	Low	
5	RPV top head 	Main material Low-alloy steel	Disc cutter, AWJ	① Cut the RPV nozzle and make a hole. ② Cut the RPV top head into pieces, start cutting from the opened hole at the nozzle.	Medium	
6	Dryer 	Main material SUS	Disc cutter, sabre saw, AWJ	① First cut the top section of the dryer into pieces by the cutting device and remove, then continue the same operation downward. ② Cut the skirt section into pieces and remove, after the completion of the removal of the dryer.	Medium	

6. Implementation details of this project

6.2. Implementation details

2) Development of Element Technology for Retrieval Device Installation

(2) Development of Interference Object Removal during Fuel Debris Retrieval



a. Method to remove interfering objects by the fuel debris retrieval device designed for the top access method

method

Interfering objects that need to be removed (including reactor internals) were listed along with relevant information.

: Element tests were performed.

* Degree of difficulty scores in the table are based on relative evaluation

No.	Interfering objects	Outline specifications	Proposed processing methods	Examples of removal methods	Degree of difficulty of removal*	Notes
7	 <p>Separator</p>	Main material SUS	Disc cutter, sabre saw, AWJ	① First cut the top section of the separator into pieces by the cutting device and remove, then continue the same operation downward. ② Cut the shroud head into pieces and remove after the completion of the removal of the separator.	Medium	
8	 <p>Reactor core</p>	Main material SUS	Disc cutter, milling, AWJ, laser	① Cut remaining structures into pieces and remove from top to bottom, depending on the condition of the melting and damage of the structure.	High	· The structure may have been deformed by melting.
9	 <p>Reactor bottom</p>	Main material Low-alloy steel/SUS	Disc cutter, milling, AWJ, laser	① Cut fallen objects and fuel debris into pieces or crush them and remove, starting from the top section and continuing downward. ② Cut and remove CRD.Hs and the like in a practical order using the method and devices arranged through the side access route to the pedestal in combination.	High	· The structure may have been deformed by melting. · <u>The implementation of CRD.H fall prevention measures is difficult.</u> · <u>CRD.Hs are closely linked to the side access method.</u>

6. Implementation details of this project

6.2. Implementation details

2) Development of Element Technology for Retrieval Device Installation

(2) Development of Interference Object Removal during Fuel Debris Retrieval

a. Method to remove interfering objects by the fuel debris retrieval device designed for the top access method

Elemental tests were planned for the removal of fuel debris and structures in the reactor bottom section since this operation was closely linked to the side access method, which was prioritized in the direction for the retrieval method, and it involved difficult implementation, such as object fall prevention measures during removal operation.

- Purpose of development
 - Feasibility demonstration of cutting work in a narrow place
 - Feasibility demonstration of processing methods that take into consideration object fall prevention measures
 - Verification of the workability of removal methods that are designed based on the top access method, side access method, or the combination of them

- Issues to be solved
 - Operability of remote operation
 - Cutting methods applicable to narrow places
 - Cutting and removal methods that take into consideration CRD.H fall prevention measures

- Expected outcome
 - Feasibility of processing methods used in a narrow place
 - Feasibility of processing methods that take into consideration object fall prevention measures
Specifically, the verification of workability of CRD.Hs removal operation including the cutting of them, transportation of the cut pieces, and the storing of them in a container
 - Feasibility of removal methods that are designed based on the top access method, side access method, or the combination of them
 - Study of throughput.

6. Implementation details of this project

6.2. Implementation details

2) Development of Element Technology for Retrieval Device Installation

(2) Development of Interference Object Removal during Fuel Debris Retrieval

a. Method to remove interfering objects by the fuel debris retrieval device designed for the top access method

Element tests that aimed at the successful implementation of interfering objects removal from the reactor bottom were planned and performed by focusing on the technologies needed to achieve CRD.H removal operation safely, since this operation involved the most difficult work such as cutting work in a narrow place, necessity of grabbing an object while cutting it, and the implementation of fall prevention measures.

Major: High in technical difficulty (3 points)
 Medium: Medium in technical difficulty (1 point)
 Minor: Low in technical difficulty (0 point)
 (Solved by existing technologies)

Summary of issues and evaluation results of reactor bottom interfering objects removal operation

No.	Structures to be removed	Main issues				Evaluation result (score)	Notes
		Work in narrow places	Necessity of grabbing the object during cutting (cutting reaction force)	Difficulty of cutting (thickness, etc.)	Necessity of fall prevention measures		
1	RPV bottom head	Small	Small	Large	Large	6 points	
2	Grating	Medium	Small	Small	Medium	2 points	
3	Heat insulating material	Medium	Small	Small	Medium	2 points	
4	Beam	Medium	Medium	Large	Medium	6 points	
5	Hanger rod	Medium	Medium	Medium	Medium	4 points	
6	CRD.H support	Medium	Medium	Medium	Medium	4 points	
7	CRD insertion/withdrawal pipe	Medium	Medium	Small	Medium	3 points	
8	CRD.H	Major ^{*1}	Major ^{*2}	Major ^{*3}	Major ^{*4}	12 points	

*1: Ranked "Major" because the distance between CRD.Hs is small.
 *2: Ranked "Major" because greater reaction force is expected when cutting CRD.Hs compared to other structures due to the possible existence of fuel debris in them.
 3: Ranked "Major" taking into consideration the possibility of the presence of fuel debris in or on the surface of CRD.Hs as with the paragraph 2 above.
 *4: Ranked "Major" taking into consideration the necessity of fall prevention measures for CRD.H internal structures and fuel debris.

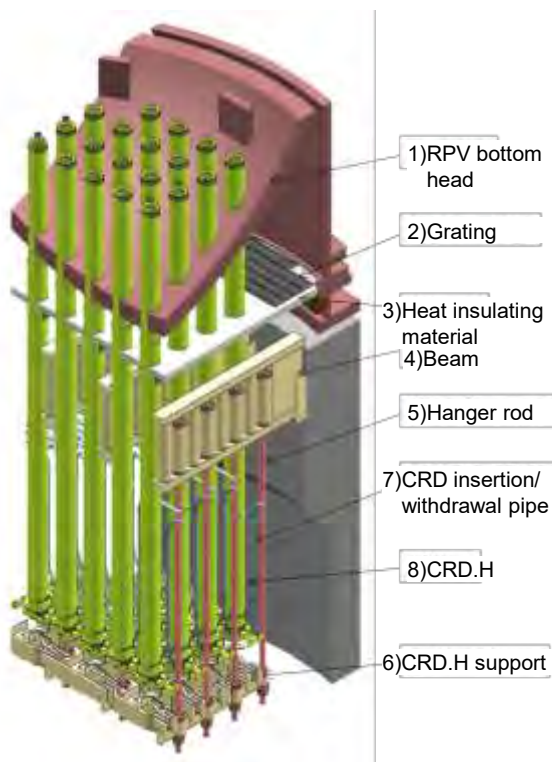

Estimated interfering objects in the reactor bottom

: Object reproduced in the element test mock-up

6. Implementation details of this project

6.2. Implementation details

2) Development of Element Technology for Retrieval Device Installation

(2) Development of Interference Object Removal during Fuel Debris Retrieval

a. Method to remove interfering objects by the fuel debris retrieval device designed for the top access method

The overview of the development and the procedures is provided. Fuel debris may adhere to the surface of CRD.Hs. For this reason, the workability of CRD.H cutting was evaluated in unit tests.

No.	Phases of reactor bottom interfering objects removal operation	Details of study and objective of tests (Confirmation items)	Unit test	Combination test	Notes
1	Cutting and removal of fuel debris in the reactor bottom	<ul style="list-style-type: none"> Conceptual study is performed aiming at developing technologies and methods that contribute to the removal of fuel debris and interfering objects in the reactor bottom. It is considered rational to evaluate the feasibility of CRD.H removal operation, based on the result of element tests planned and performed after careful consideration of potential issues that may arise in connection with the operation. (Removal of CRD.Hs is considered to be the most difficult work of all object removal operations from the reactor bottom.) 	-	-	Cutting tests are performed separately.
2	Fuel debris collection and transportation				
3	RPV bottom head opening				
4	Gating heat insulating material removal				
5	Hanger rod removal				
6	CRD.H support removal				
7	CRD.H cutting tool positioning	The CRD.H cutting tool shall be able to be positioned at a desired position and to be held firmly.		○	
8	CRD.H collection tool positioning	The CRD.H collection tool shall be able to be positioned at a desired position and to be held firmly.		○	
9	Cutting by the CRD.H cutting tool	The selected cutting method shall satisfy cutting needs at planned locations.	○	○	Preliminary tests are performed to select a cutting tool
10	Transportation of cut pieces by the CRD.H collection tool	Cut pieces of CRD.Hs shall be able to be held by the collection tool and transported to the proximity of the UC.		○	
11	Putting cut piece in the UC by the collection arm	Cut pieces of CRD.Hs held by the collection tool shall be able to be put in the UC.		○	

○: Tests performed

6. Implementation details of this project

6.2. Implementation details

2) Development of Element Technology for Retrieval Device Installation

(2) Development of Interference Object Removal during Fuel Debris Retrieval

a. Method to remove interfering objects by the fuel debris retrieval device designed for the top access method

The image of interfering objects (including CRD.H) removal operation in the reactor bottom is illustrated in the figure below.

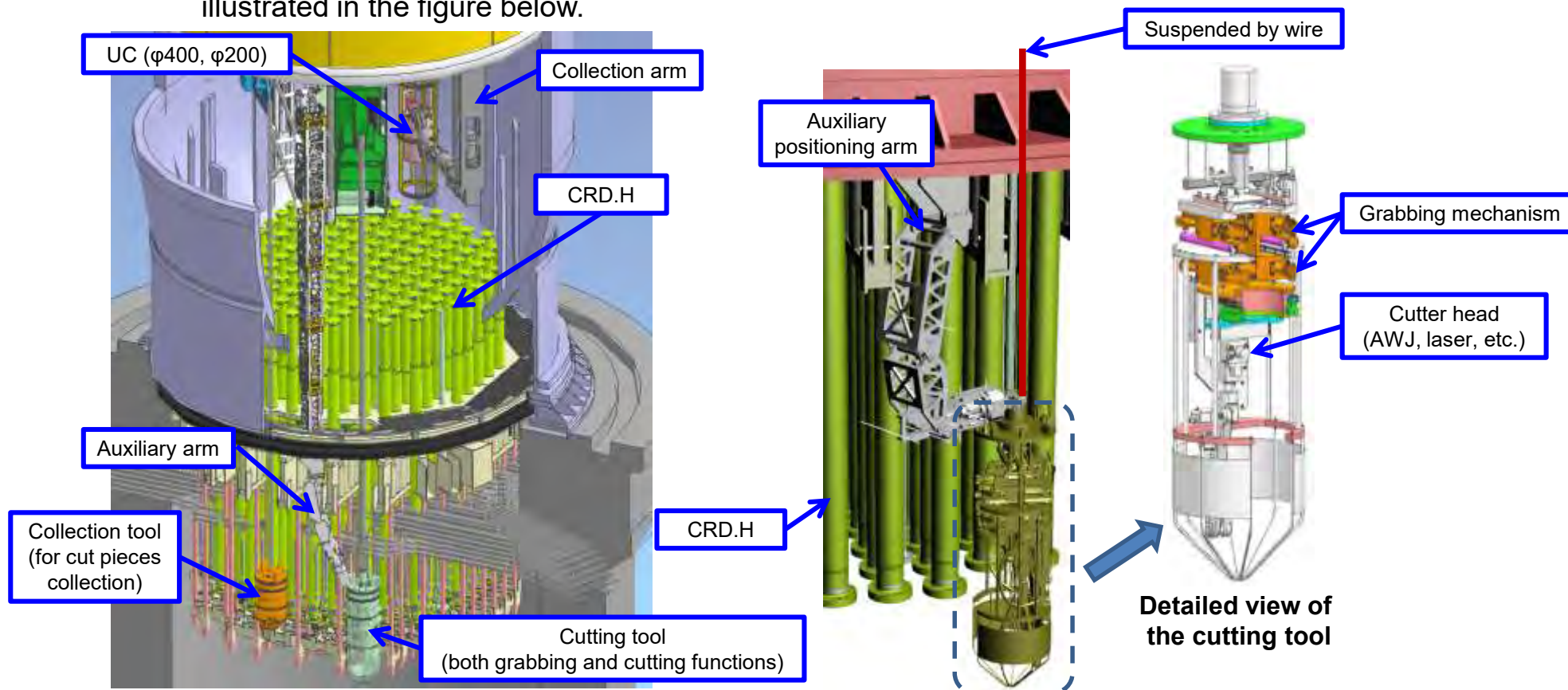

Image of interfering objects removal operation in the reactor bottom

Image of processing by the cutting tool

6. Implementation details of this project

6.2. Implementation details

2) Development of Element Technology for Retrieval Device Installation

(2) Development of Interference Object Removal during Fuel Debris Retrieval

a. Method to remove interfering objects by the fuel debris retrieval device designed for the top access method

Main approach to the development concerning interfering objects (including CRD.H) removal operation in the reactor bottom are clarified.

No.	Item	Approaches to development work	Notes
1	Interfering objects removal operation procedures	<ul style="list-style-type: none"> The following sequential steps shall be taken: first, shield plug, DSP slot plug, PCV head, reactor heat insulating material, RPV top head, dryer, separator, and reactor core section (including fuel debris) are removed; then, fuel debris and CRD.Hs in the reactor bottom are removed. 	
2	Transportation route	<ul style="list-style-type: none"> Interfering objects in the reactor bottom shall be cut and removed by way of the top access method and moved out via the operation floor. Conceptual study will be performed on the combined use of the top access and side access methods separately. 	
3	Establishment of access to CRD.Hs via the RPV bottom	<ul style="list-style-type: none"> Greater difficulty is expected to gain an access to CRD.Hs via the center of the RPV bottom since this area may have been seriously damaged due to melted fuel debris. On the other hand, less damage is predicted in the lower section of the inside of the RPV. Therefore, establishing an access to them via the lower section of the RPV inner wall will be attempted by opening new holes on the wall. The access method may be reviewed when the PCV and RPV internal investigations are completed and new information is provided. 	
4	Opening for access	<ul style="list-style-type: none"> The dimensions of the access holes shall be small enough to prevent the fall of CRD.Hs in the bottom of the inside of the RPV during opening work. The dimensions of the access holes will be investigated on the premise of applying it to Units 2 and 3. * 	
5	CRD.H cutting device	<ul style="list-style-type: none"> The unit shall be equipped with the following functions needed to execute the cutting work: grabbing, cutting, fall prevention, collection, and positioning. Those functions will be borne by multiple devices taking into consideration the dimensions of the holes and work efficiency. 	
6	CRD.H cutting tool	<ul style="list-style-type: none"> Cutting tools that fit the needs of narrow place work and the shape of the CRD.H will be selected within the range of existing technologies. Preliminary cutting tests will be performed on selected tools to determine the tools to be used in element tests. 	
7	Fall prevention measures	<ul style="list-style-type: none"> Fall prevention measures shall be implemented for CRD.H cutting and removal operation. Fall prevention measures shall be implemented for molten material that may exist in CRD.Hs as well. 	

* Conceptual study and element tests will be performed focusing on Unit3, which is the intended target of throughput analysis. Conceptual study will be performed on Unit 1.

6. Implementation details of this project

6.2. Implementation details

2) Development of Element Technology for Retrieval Device Installation

(2) Development of Interference Object Removal during Fuel Debris Retrieval

a. Method to remove interfering objects by the fuel debris retrieval device designed for the top access method

Conditions for the construction of access openings needed for interfering objects (including CRD.H) removal operation in the reactor bottom were examined.

The drawing of the opening that can be constructed in the lower section of the RPV inner wall is shown below. The approach to allocate the functions needed for CRD.H cutting and removal operation to multiple devices separately was taken due to a limited space for work.

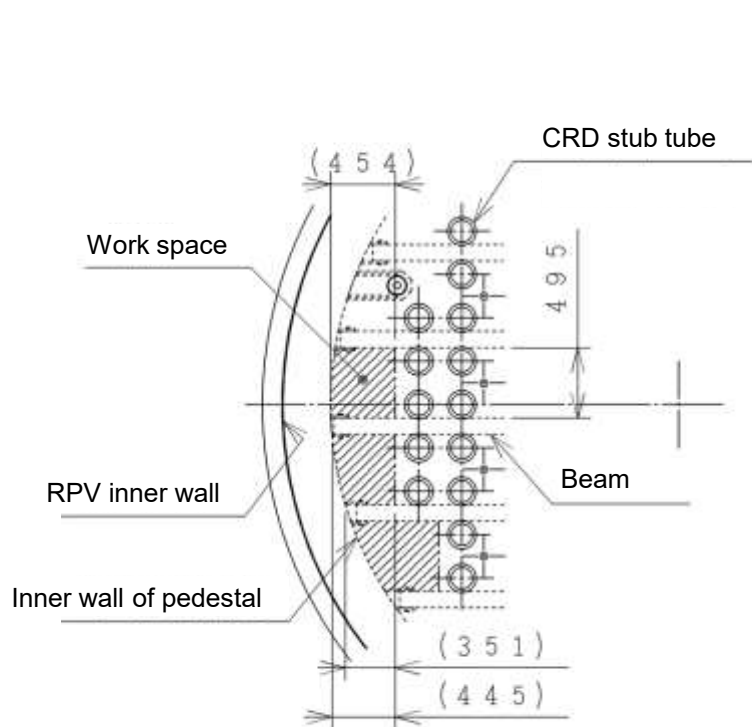

Opening dimensions for Unit 2 and 3

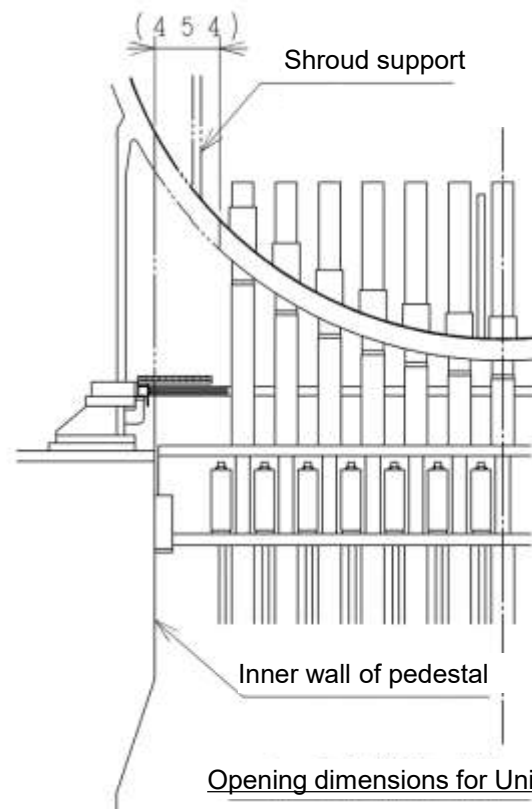

Opening dimensions for Unit 2 and 3

7. Implementation Details of This Project

7.2. Implementation details

2) Development of Element Technology for Retrieval Device Installation

(2) Development of Interference Object Removal during Fuel Debris Retrieval

a. Method to remove interfering objects by the fuel debris retrieval device designed for the top access method

Work steps were studied to clarify functions needed for interfering objects (including CRD.H) removal and fuel debris retrieval from the reactor bottom and issues in relation to the realization of the functions. Note that it was made compulsory for devices to be developed to provide the function of sealing, dust prevention, and radiation shielding as contamination spread prevention measures, according to the development results by the Annual Research Report of FY2014 Subsidized Project* (RPV inner surface seal and open/close port).

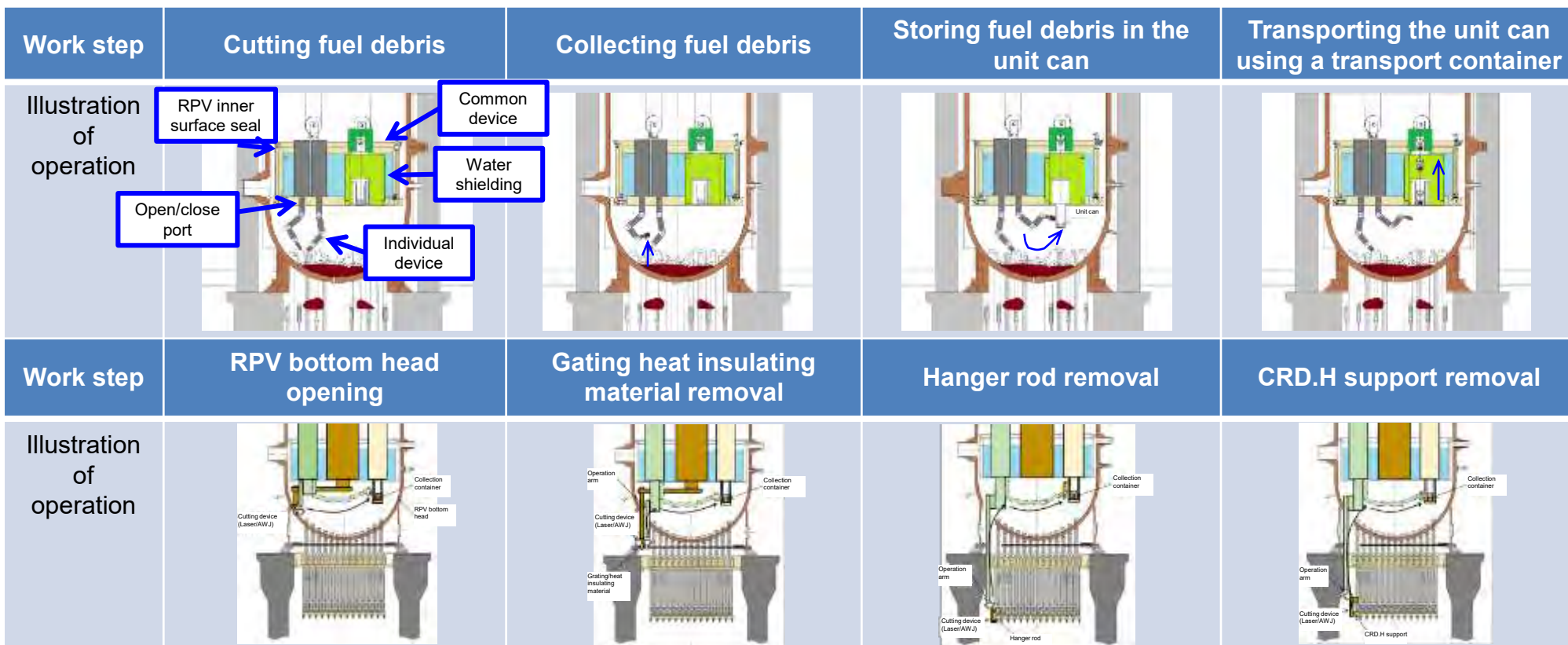

6. Implementation details of this project

6.2. Implementation details





2) Development of Element Technology for Retrieval Device Installation

(2) Development of Interference Object Removal during Fuel Debris Retrieval

a. Method to remove interfering objects by the fuel debris retrieval device designed for the top access method

Work steps were studied to clarify functions needed for interfering objects (including CRD.H) removal and fuel debris retrieval from the reactor bottom and issues in relation to the realization of the functions.

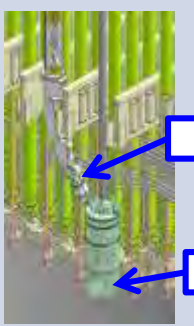
 : Scope of simulation for element tests

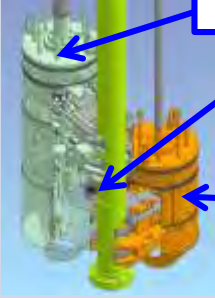
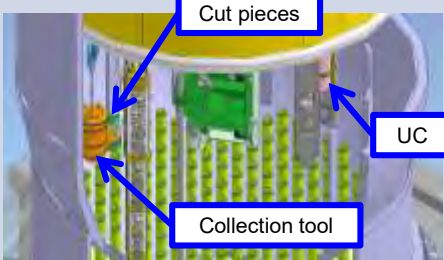
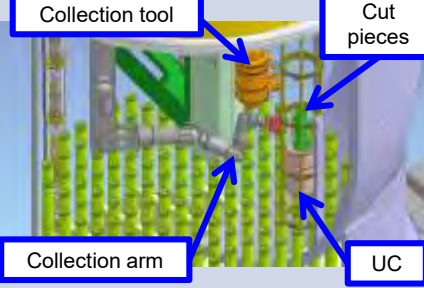
Work step	CRD.H Installing cutting tool	Installing auxiliary arm	Positioning cutting tool by auxiliary arm	Grabbing CRD.H by cutting tool
Illustration of operation	 <p>Suspending device CRD.H Cutting tool</p>	 <p>Auxiliary arm Cutting tool</p>	 <p>Auxiliary arm Cutting tool</p>	 <p>Cutting tool CRD.H grabbing position</p>
Work step	Positioning collection tool, Grabbing CRD.H (fall prevention)	Cutting CRD.H by cutting tool	Collecting cut pieces by collection tool	Storing cut piece in the UC
Illustration of operation	 <p>Auxiliary arm Collection tool</p>	 <p>Cutting tool Cutter head (AWJ, laser, etc.) Collection tool (Fall prevention)</p>	 <p>Cut pieces UC Collection tool</p>	 <p>Collection tool Cut pieces Collection arm UC</p>

6. Implementation details of this project

6.2. Implementation details

2) Development of Element Technology for Retrieval Device Installation

(2) Development of Interference Object Removal during Fuel Debris Retrieval

a. Method to remove interfering objects by the fuel debris retrieval device designed for the top access method

Functional requirements for the fuel debris retrieval device were identified based on the result of study on the work steps of interfering objects (including CRD.H) removal and fuel debris retrieval operation in the reactor bottom.

- Functional requirements for the fuel debris retrieval device : Areas covered by the element tests
 - Estimated interfering objects and fuel debris in the reactor bottom shall be able to be cut and removed by the fuel debris retrieval device. For this purpose, cutting tools that are capable of processing target interfering objects and fuel debris shall be applicable.
 - Cut or dug out pieces of interfering objects and fuel debris shall be able to be put in the dedicated collection containers by the fuel debris retrieval device so that they shall be able to be transferred to the transportation route.
 - Holes shall be able to be opened in the lower section of the RPV so that the CRD.H removal unit of the fuel debris retrieval device can gain access to the inside of the RPV.
 - The CRD.H removal unit shall be able to be located near CRD.Hs through the access holes opened in the lower section of the RPV.
 - The CRD.H removal unit shall be capable of preventing the falling of cut pieces of CRD.Hs during cutting and removal operation.
 - The cut pieces of CRD.Hs shall be able to be transferred to the transportation route.
 - Monitoring of remote operation of the operation above is possible.

6. Implementation details of this project

6.2. Implementation details

2) Development of Element Technology for Retrieval Device Installation

(2) Development of Interference Object Removal during Fuel Debris Retrieval

a. Method to remove interfering objects by the fuel debris retrieval device designed for the top access method

Preliminary tests were needed to screen the processing methods that were considered effective to process estimated interfering objects (as well as fuel debris that may adhere to them) and listed as candidates according to the functional

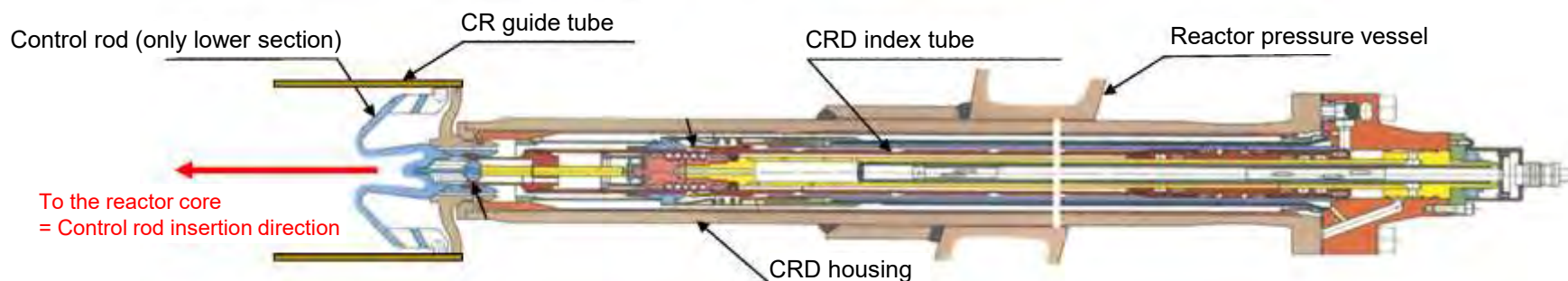

Illustration of CRD.H structure

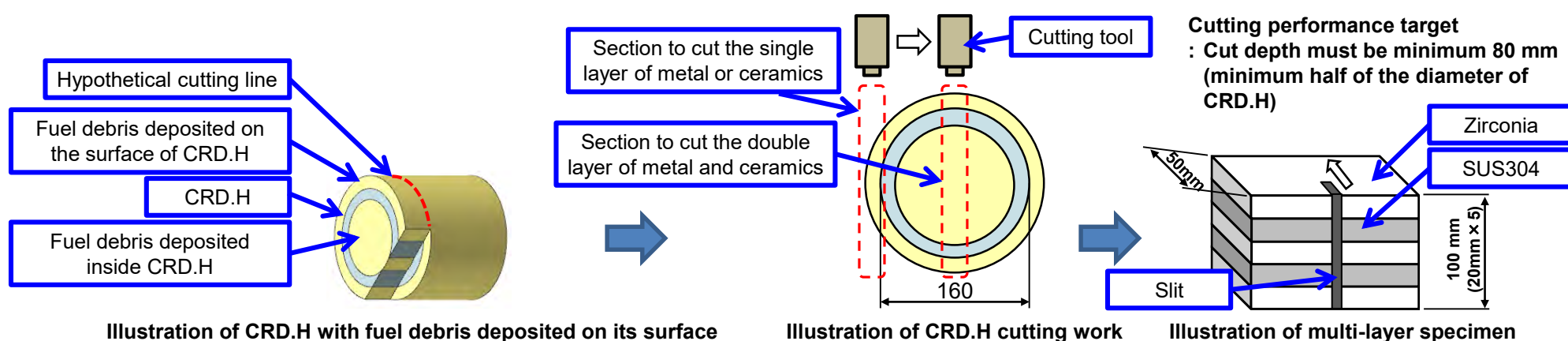

Illustration of CRD.H with fuel debris deposited on its surface

Illustration of CRD.H cutting work

Illustration of multi-layer specimen

6. Implementation details of this project





6.2. Implementation details

2) Development of Element Technology for Retrieval Device Installation

(2) Development of Interference Object Removal during Fuel Debris Retrieval

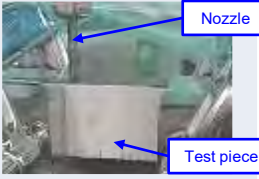
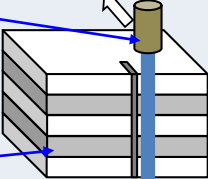
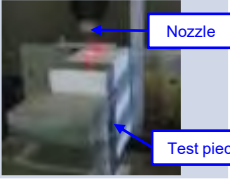
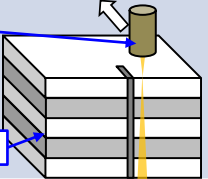
a. Method to remove interfering objects by the fuel debris retrieval device designed for the top access method

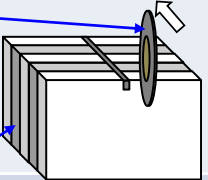
Preliminary tests were performed to assess the applicability of the processing methods that were considered effective to process estimated interfering objects (as well as fuel debris that may adhere to them) according to the functional requirements. : Selected as the cutting tool of the CRD.H cutting and removal unit

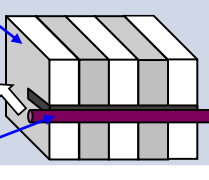
No.	Cutting tool	Test details		Cutting efficiency (representative value) = $\frac{\text{Depth (mm)} \times \text{Length (mm)}}{\text{cutting time (min)}}$	Result	Assessment
		Photo of test system	Illustration			
1	AWJ (350MPa)			75 mm ² /min (= 56 mm × 50 mm / 37.5 min)	<ul style="list-style-type: none"> Although the cut depth by AWJ is less than that by laser, it is considered applicable to cutting work, subject to improvement by tuning process conditions. Generating more waste is an issue. (Supply amount: 500 g/min) 	△
2	Laser (8kW)			602 mm ² /min (= 100 mm × 50 mm / 8.3 min)	<ul style="list-style-type: none"> It was determined applicable to cutting work based on its cut depth. 	○
3	Disc cutter			750 mm ² /min (= 1.5 mm × 100 mm / 0.2 min)	<ul style="list-style-type: none"> The necessity of replacing the cutter blade 10 times or more to cut one CRD.H is an issue. (Degradation of cutting performance was observed after cutting an area of about 1500 mm².) Downsizing the device is difficult. 	×
4	Wire saw			1000 mm ² /min (= 25 mm × 100 mm / 2.5 min)	<ul style="list-style-type: none"> Quick wear of the wire and the necessity of replacing the wire in every or every other CRD.H cutting work due to said property is an issue. (Degradation of cutting performance was observed after about 20 minutes of cutting work.) Downsizing the device is difficult. 	×

6. Implementation details of this project

6.2. Implementation details

2) Development of Element Technology for Retrieval Device Installation

(2) Development of Interference Object Removal during Fuel Debris Retrieval

a. Method to remove interfering objects by the fuel debris retrieval device designed for the top access method

A photo of a multi-layer specimen after being cut is shown as supplementary information.

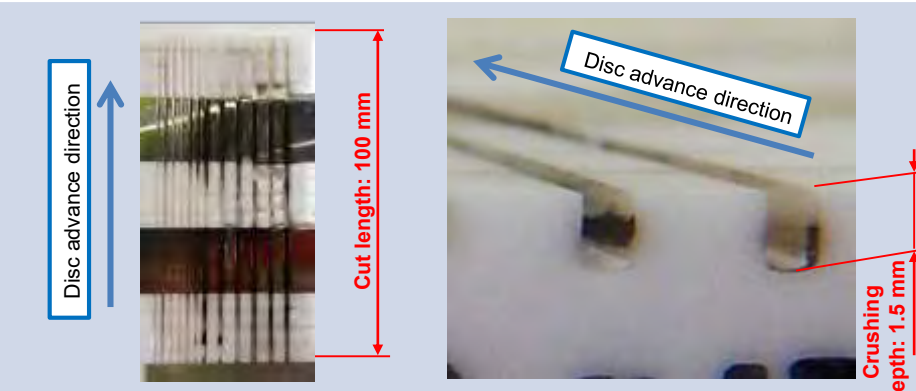
1. AWJ (350 MPa)	2. Laser (8 kW)
 <p>A trend of decrease in straightness of cut line with increase in cut depth was observed.</p>	 <p>It was demonstrated to be capable of cutting SUS304 and fracturing zirconia.</p>
3. Disc cutter	4. Wire saw
 <p>Disc wear and device size are issues.</p>	 <p>Wire wear and device size are issues.</p>

6. Implementation details of this project

6.2. Implementation details

2) Development of Element Technology for Retrieval Device Installation

(2) Development of Interference Object Removal during Fuel Debris Retrieval

a. Method to remove interfering objects by the fuel debris retrieval device designed for the top access method

Basic specifications of the CRD.H removal unit were made clear based on the functional requirements and the results of preliminary test to ensure successful CRD.H removal operation.

No.	Functional requirements	Required functions	Basic specifications of the CRD.H cutting and removal unit	Notes
1	The CRD.H removal unit shall be able to be located near CRD.Hs through the access holes opened in the lower section of the RPV.	<ul style="list-style-type: none"> The unit shall be able to be located near CRD.Hs along with necessary utility supply lines. The cutting tool shall be able to be precisely located at a planned cut position near CRD.Hs. 	<ul style="list-style-type: none"> Dimensions of the components and tools of the unit shall be designed so that they can pass through the access holes opened in the lower section of the RPV. The device shall be designed so that it is suspended near CRD.Hs and can be supplied with necessary utilities from the RPV. The auxiliary arm shall be installed to support the precise positioning of the tools near CRD.Hs. 	
2	The CRD.H removal unit shall be capable of preventing the falling of cut pieces of CRD.Hs during cutting and removal operation.	<ul style="list-style-type: none"> The unit shall be capable of cutting CRD.Hs. Fall preventive measures shall be in effect for cut pieces of CRD.Hs after being cut off. 	<ul style="list-style-type: none"> The cutting tools selected through the preliminary cutting tests shall be adopted. CRD.Hs shall be grabbed by appropriate means while being cut to deal with cutting reaction force. The grabbing position shall be above the cutting line so that the cut piece can be removed. The cutting tool shall be designed to integrate the grabbing and cutting functions. The cut piece of the CRD.H shall be grabbed to prevent falling after being cut off. The grabbing position for fall prevention and subsequent collection shall be under the cutting line. The collection tool shall be designed to integrate the grabbing and fall prevention functions. 	
3	The cut pieces of CRD.Hs shall be able to be transferred to the transportation route.	<ul style="list-style-type: none"> The cut piece of the CRD.H shall be able to be grabbed after being cut off. Fall prevention measures shall be implemented for cut pieces of CDR.Hs during transportation. Cut pieces of CRD.Hs shall be able to be stored in the UC. 	<ul style="list-style-type: none"> The CRD.H removal unit shall be designed so that cut pieces of CRD.Hs are grabbed and transported to the proximity of the UC by the collection tool with fall preventive measures in effect. The collection arm shall be installed near the UC to put the cut piece grabbed by the collection tool in the UC. 	
4	Monitoring of remote operation of the tasks above is possible.	Every work step shall be able to be monitored.	Cameras shall be installed near the tools and arms so that every work step can be monitored.	

6. Implementation details of this project

6.2. Implementation details

2) Development of Element Technology for Retrieval Device Installation

(2) Development of Interference Object Removal during Fuel Debris Retrieval

a. Method to remove interfering objects by the fuel debris retrieval device designed for the top access method

A simulated specimen was developed for fundamental tests that would be conducted to determine the cutting condition used in the mockup test.

It was decided to prepare two types of test units: one simulated a CRD.H with light damage, and the other simulated a CRD.H with heavy damage.

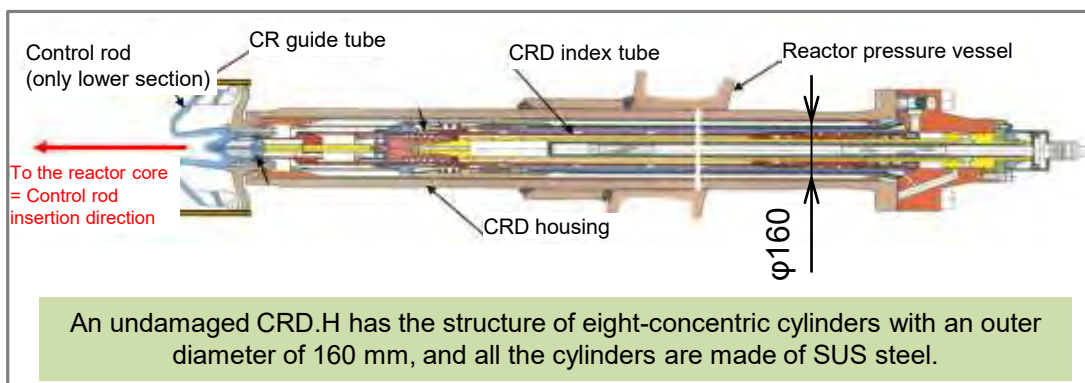
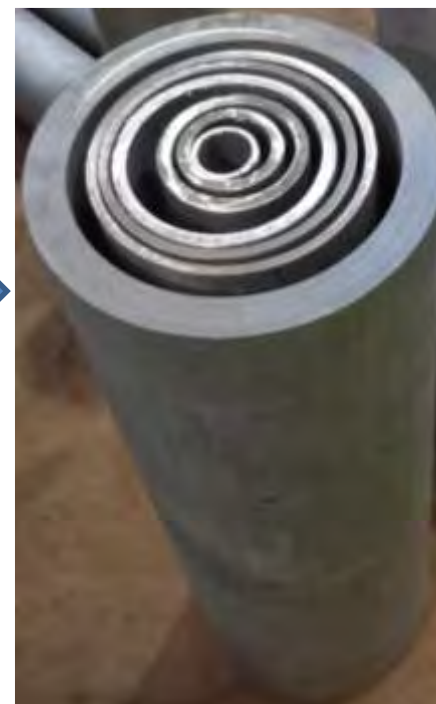

Illustration of a CRD.H with light damage.
 ==> The test unit simulates only the cylinders



Simulated
test
cylinder



SUS eight-concentric test cylinders

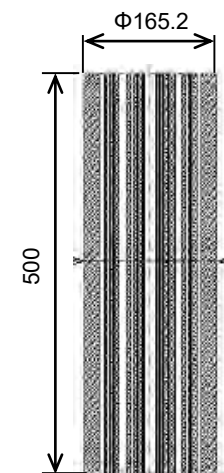

6. Implementation details of this project

6.2. Implementation details

2) Development of Element Technology for Retrieval Device Installation

(2) Development of Interference Object Removal during Fuel Debris Retrieval

a. Method to remove interfering objects by the fuel debris retrieval device designed for the top access method

A simulated cylinder was developed for fundamental tests that would be conducted to determine the cutting condition used in the mockup test.

It was decided to prepare two types of test units one simulated a CRD.H with light damage, and the other simulated a CRD.H with heavy damage.

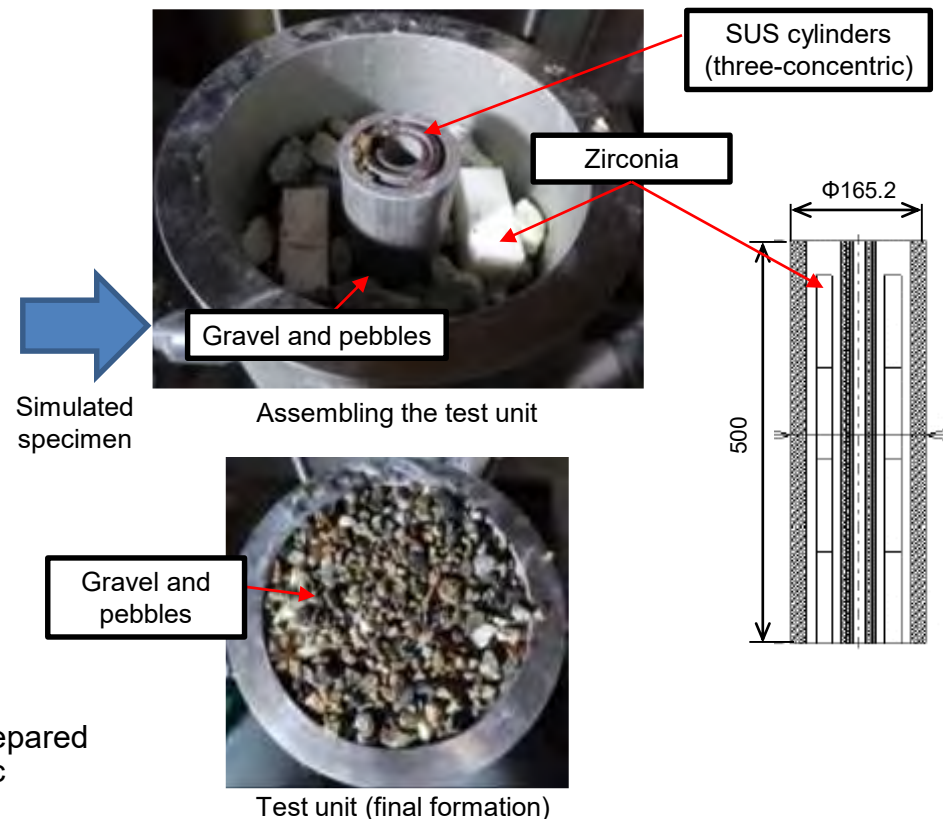
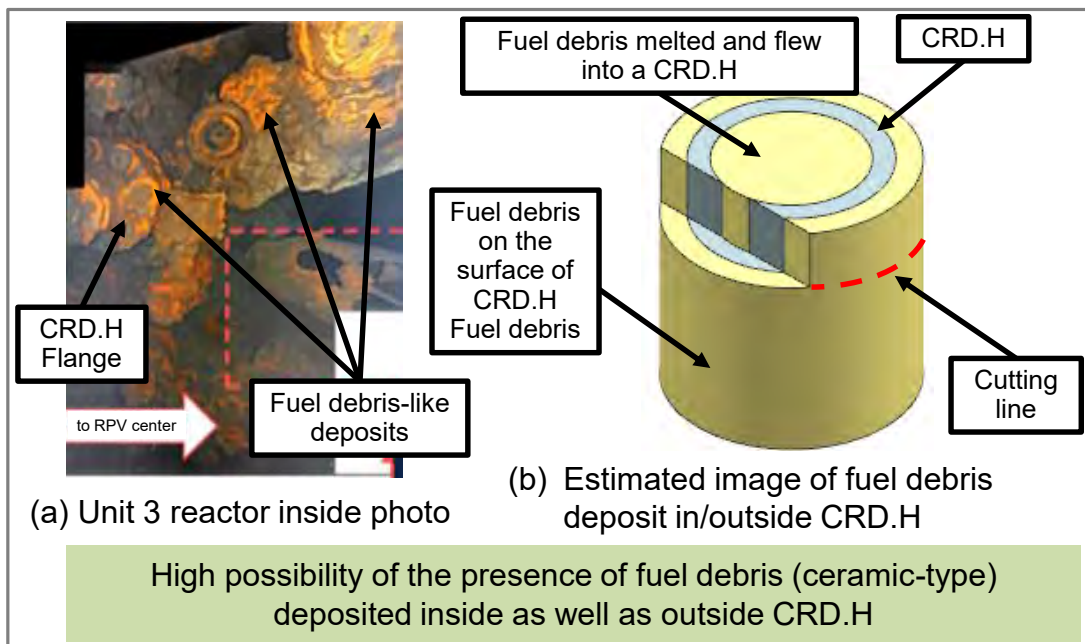

Illustration of a CRD.H with heavy damage

==> To simulate a CRD.H with fuel debris deposited in it, a test unit was prepared by arranging multiple cylinders with different diameters in an concentric manner and filling the gap of the cylinders with gravel and pebbles.

6. Implementation details of this project

6.2. Implementation details

2) Development of Element Technology for Retrieval Device Installation

(2) Development of Interference Object Removal during Fuel Debris Retrieval

a. Method to remove interfering objects by the fuel debris retrieval device designed for the top access method

Cutting methods tested in basic test and confirmation items were considered and screened.

● Illustration of CRD.H simulant cutting test

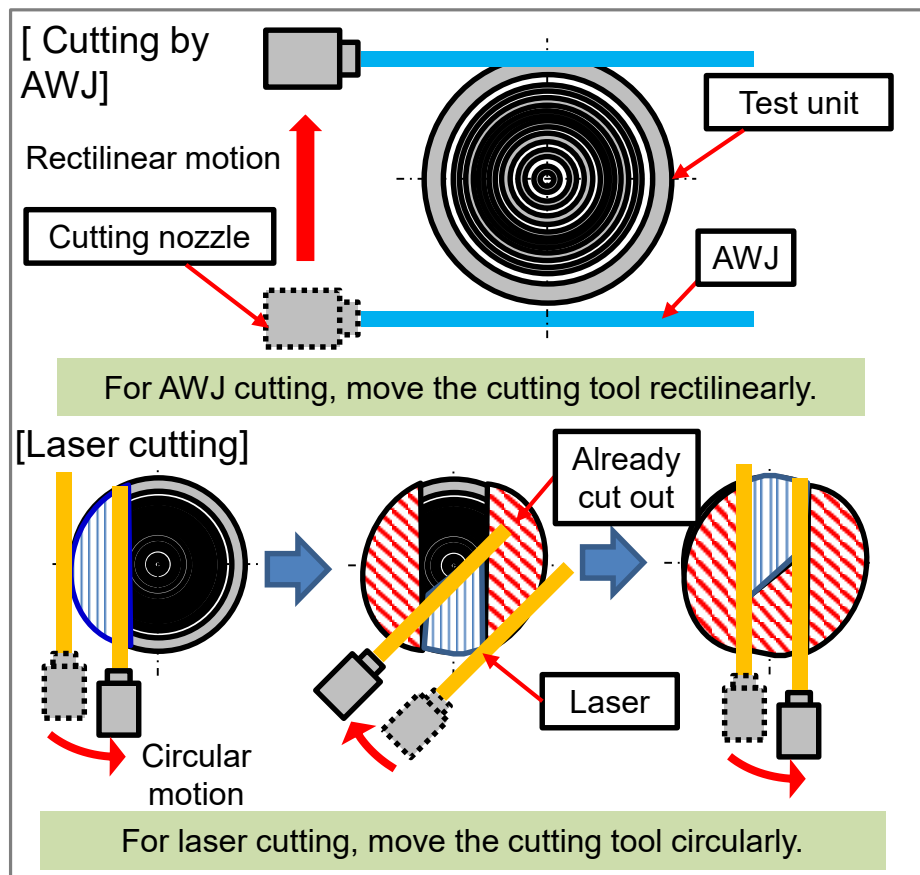

● Configuration of the test system (AWJ cutting test)

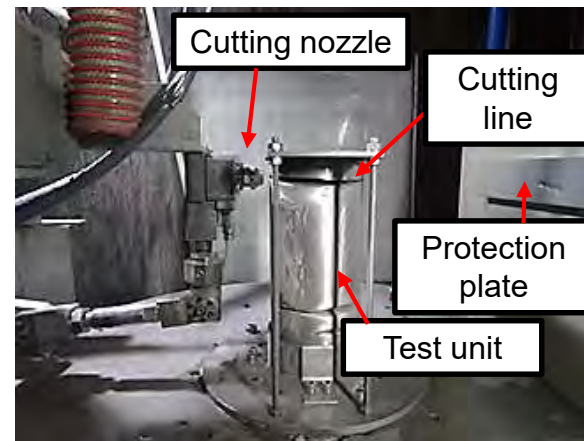

● Main confirmation items of CRD.H simulant cutting tests

- Whether completely cut and separated or not
- Cutting time (estimate from actual measurement and cutting tool feed speed)
- Amount of waste (estimate from cutting time)
- Whether any multiple-concentric cylinders' internals falling event or not

6. Implementation details of this project

6.2. Implementation details



2) Development of Element Technology for Retrieval Device Installation

(2) Development of Interference Object Removal during Fuel Debris Retrieval

a. Method to remove interfering objects by the fuel debris retrieval device designed for the top access method

Basic tests were performed, and time needed to cut and separate the test unit was calculated.

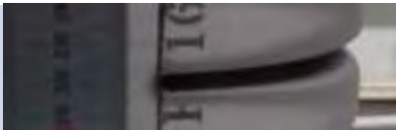
● Results of cutting tests with AWJ (representative examples)

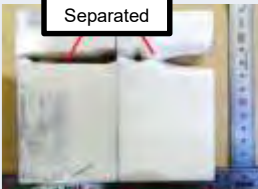
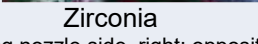
No.	Test units	Test details	The time required(representative value) = (CRD.H diameter / Feed speed) x Number of cycles needed	Test conditions and results
1	SUS eight-concentric cylinders (Light damage specimen)	 Cutting nozzle side  Opposite side of the cutting nozzle	Approx. 11 min (= $\phi 160 \text{ mm} \div 15 \text{ mm/min} \times 1 \text{ travel}$)	<ul style="list-style-type: none"> Pump pressure: 245 MPa, nozzle feed speed: 15 mm/min, abrasive feed rate: 1,800 g/min Single travel was good to cut 160-mm diameter CRD.H simulant specimen completely. Total amount of abrasive used: Approx. 20 kg (11min\times1800g/min)
2	SUS multi-concentric cylinders and ceramics (Heavy damage specimen)	 Front side  Separated  Zirconia (Left: cutting nozzle side, right: opposite side)	Approx. 320 min (= $\phi 160 \text{ mm} \div 1 \text{ mm/min} \times 2 \text{ travels}$)	<ul style="list-style-type: none"> Pump pressure: 245 MPa, nozzle feed speed: 1 mm/min, abrasive feed rate: 1,800 g/min Single travel was good to cut zirconia completely. * Second travel was considered necessary to cut and separate the specimen completely because some parts of SUS cylinders were left uncut on the far side from the cutting nozzle. Total amount of abrasive used: Approx. 580 kg (160min\times1800g/min\times2)

6. Implementation details of this project

6.2. Implementation details





2) Development of Element Technology for Retrieval Device Installation

(2) Development of Interference Object Removal during Fuel Debris Retrieval

a. Method to remove interfering objects by the fuel debris retrieval device designed for the top access method

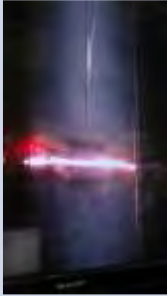
Fundamental tests were performed, and time needed to cut and separate the specimen was calculated.

● Results of cutting tests with laser (representative examples)

No.	Test units	Test details	Cutting time (representative value)	Test conditions and results
1	SUS eight-concentric cylinders (Light damage specimen)	  Cutting in progress After cutting	Approx. 207 min	<ul style="list-style-type: none"> Laser output power: 8 kW, head feed speed: 6 mm/min and 30 mm/min The head was moved circularly, and the travel of the head was repeated until the specimen was cut and separated completely.
2	SUS multi-concentric cylinders and ceramics (Heavy damage specimen)	  After cutting Cut surface	Approx. 207 min	<ul style="list-style-type: none"> It was confirmed that the specimen was cut and separated completely with the same cutting conditions as above.

6. Implementation details of this project

6.2. Implementation details

2) Development of Element Technology for Retrieval Device Installation

(2) Development of Interference Object Removal during Fuel Debris Retrieval

a. Method to remove interfering objects by the fuel debris retrieval device designed for the top access method

The CRD.H removal unit was built based on the basic specifications that were developed through project activities.

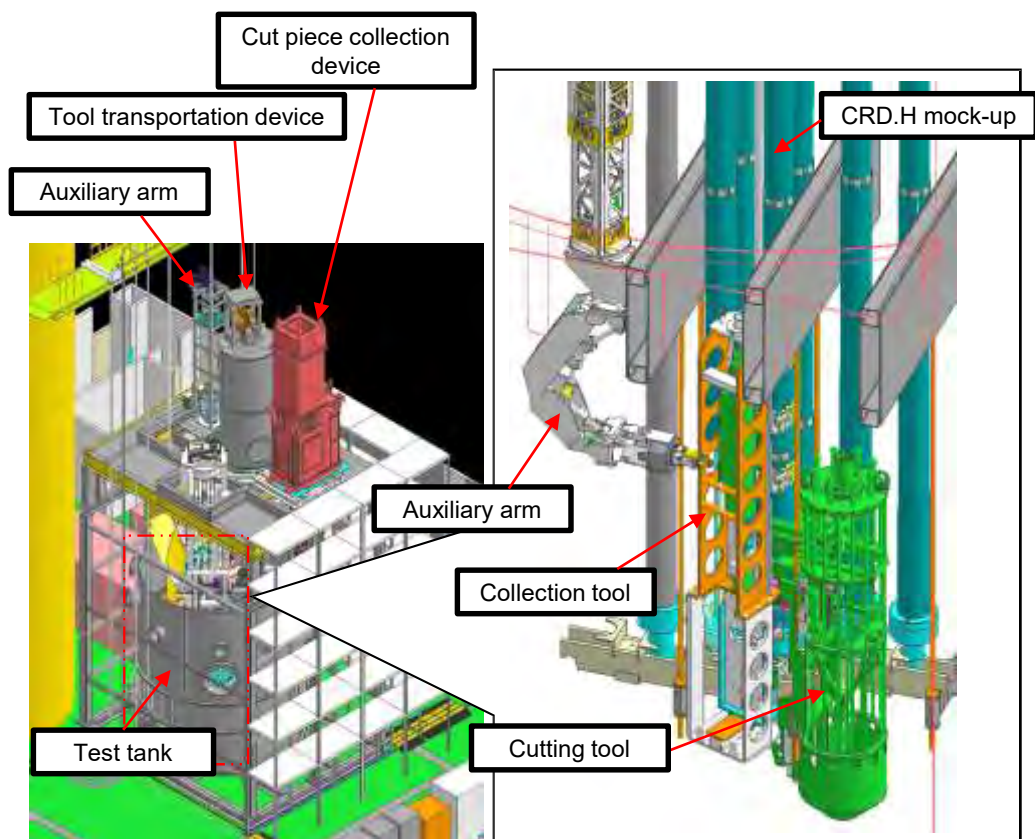

Overall view of the test unit

Equipment in the test tank



External appearance of the test tank

6. Implementation details of this project

6.2. Implementation details

2) Development of Element Technology for Retrieval Device Installation

(2) Development of Interference Object Removal during Fuel Debris Retrieval

a. Method to remove interfering objects by the fuel debris retrieval device designed for the top access method

The CRD.H mock-up were prepared in consideration of the results of internal investigations.

The CRD.H simulants for the cutting test were made by arranging multiple SUS cylinders in a concentric manner and filling the gap of them with ceramics (zirconia) to simulate a CRD.H with fuel debris deposited inside it

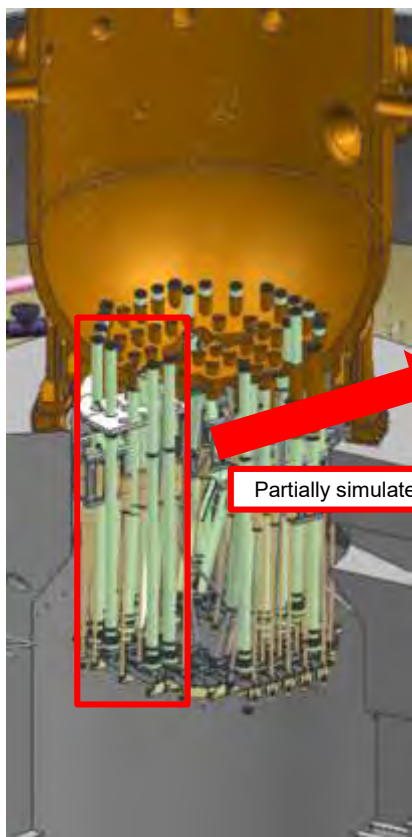

Estimated interfering objects in the reactor bottom

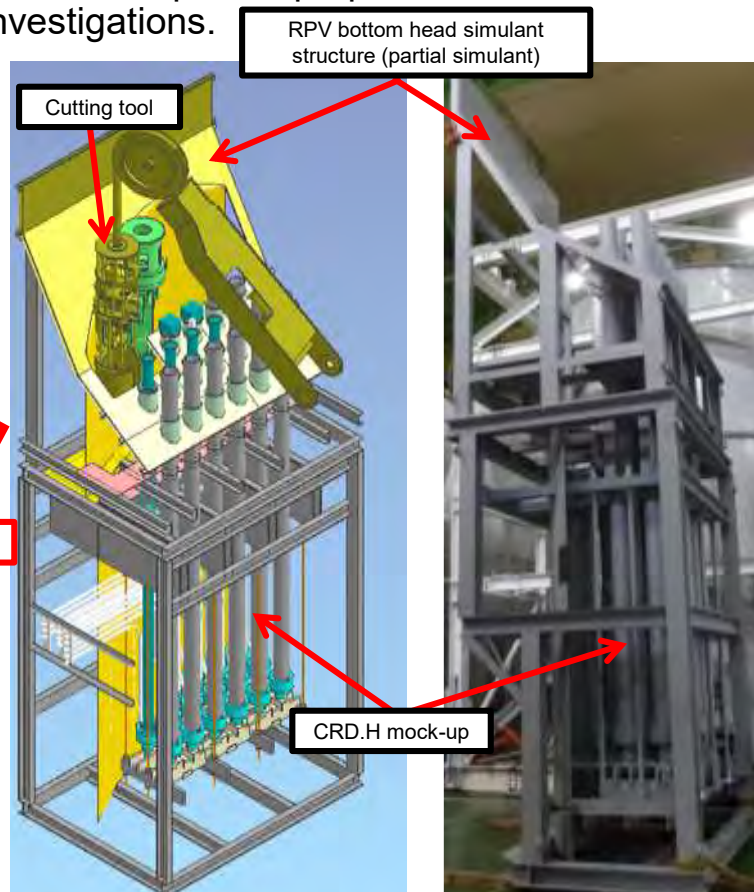
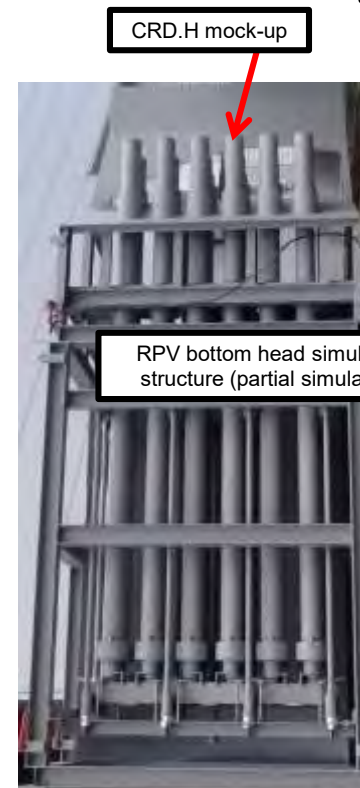
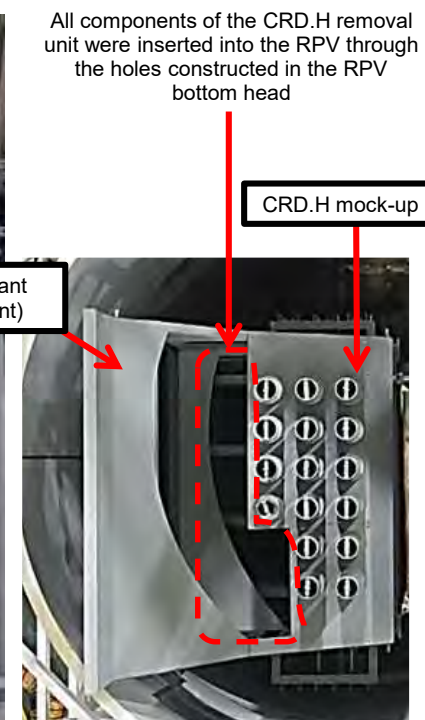

Illustration of simulated CRD.Hs with RPV bottom



Front of CRD.H mock-up



Top of CRD.H mock-up

6. Implementation details of this project

6.2. Implementation details

2) Development of Element Technology for Retrieval Device Installation

(2) Development of Interference Object Removal during Fuel Debris Retrieval

a. Method to remove interfering objects by the fuel debris retrieval device designed for the top access method

The outlines of the CRD.H removal unit are shown below.

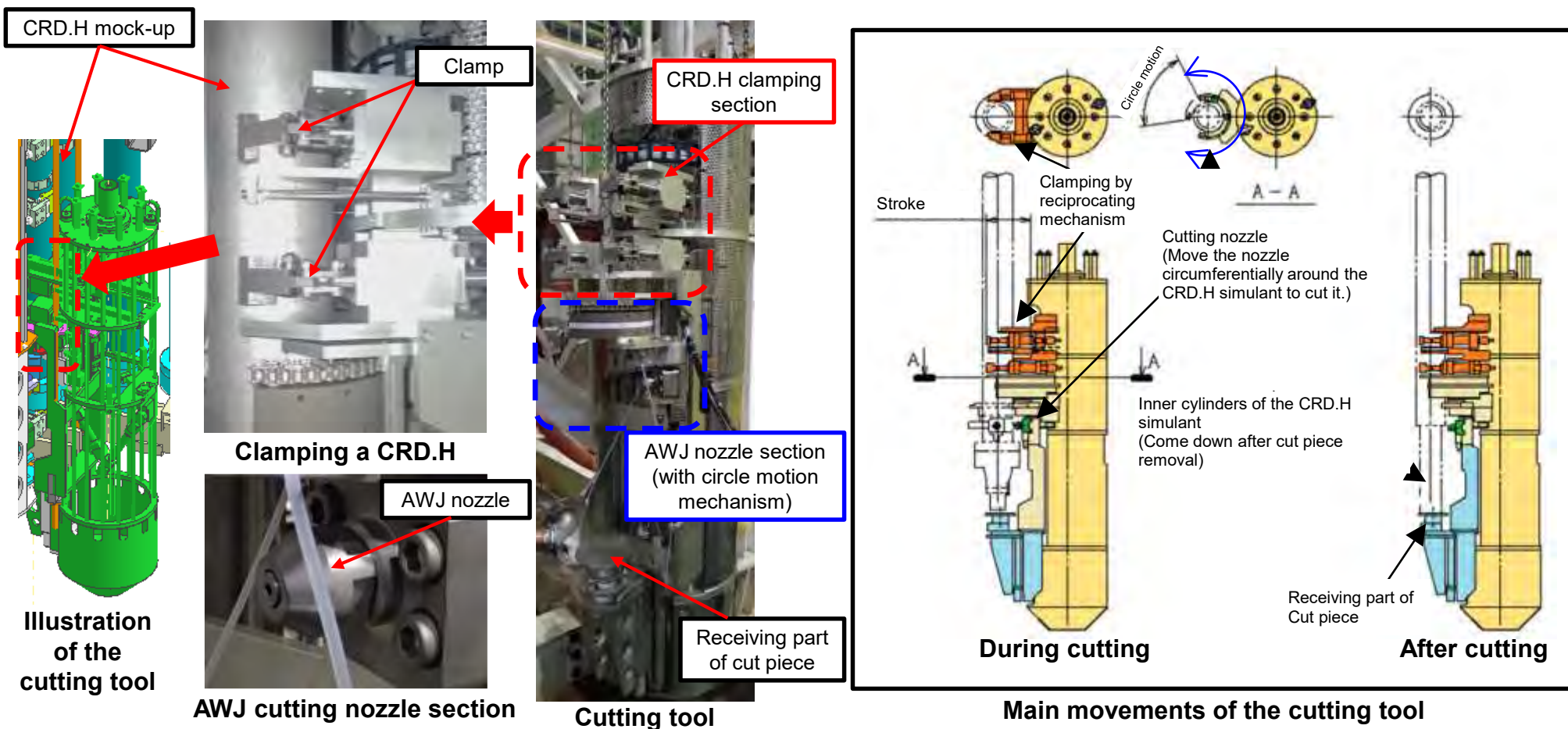

6. Implementation details of this project

6.2. Implementation details

2) Development of Element Technology for Retrieval Device Installation

(2) Development of Interference Object Removal during Fuel Debris Retrieval

a. Method to remove interfering objects by the fuel debris retrieval device designed for the top access method

The outlines of the CRD.H removal unit are shown below.



Auxiliary arm



Auxiliary arm tip

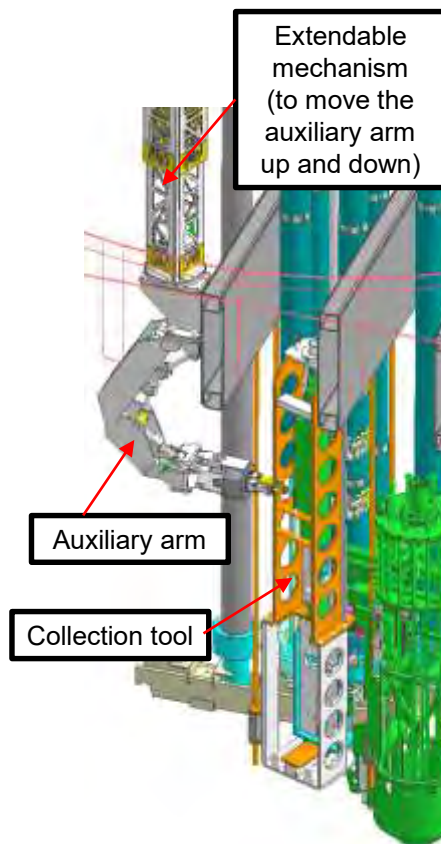
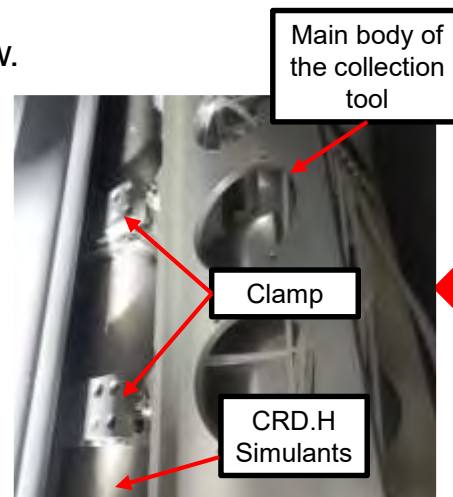
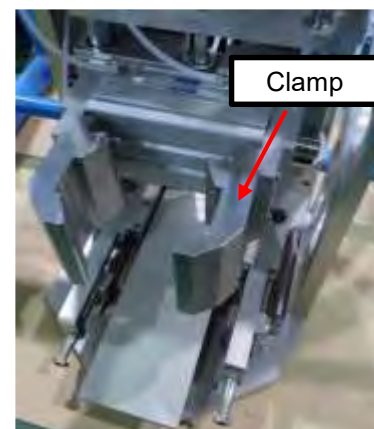

Illustration of the collection tool and auxiliary arm



Clamping a CRD.H



Cut piece pulling out and collecting section

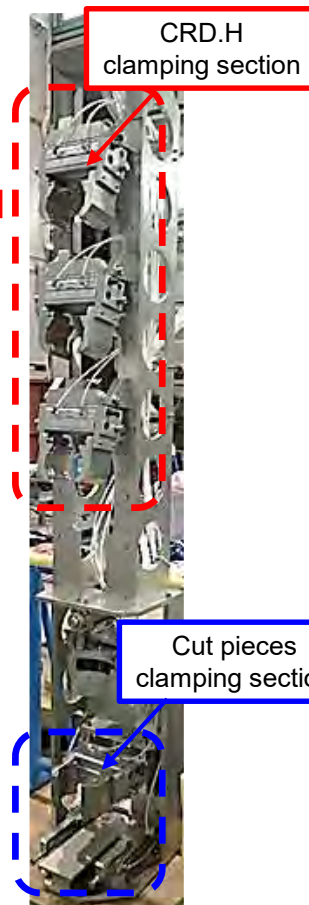

Collection tool

6. Implementation details of this project

6.2. Implementation details

2) Development of Element Technology for Retrieval Device Installation

(2) Development of Interference Object Removal during Fuel Debris Retrieval

a. Method to remove interfering objects by the fuel debris retrieval device designed for the top access method

CRD.Hs removal process was studied based on the use of the designed CRD.H cutting and removal unit.

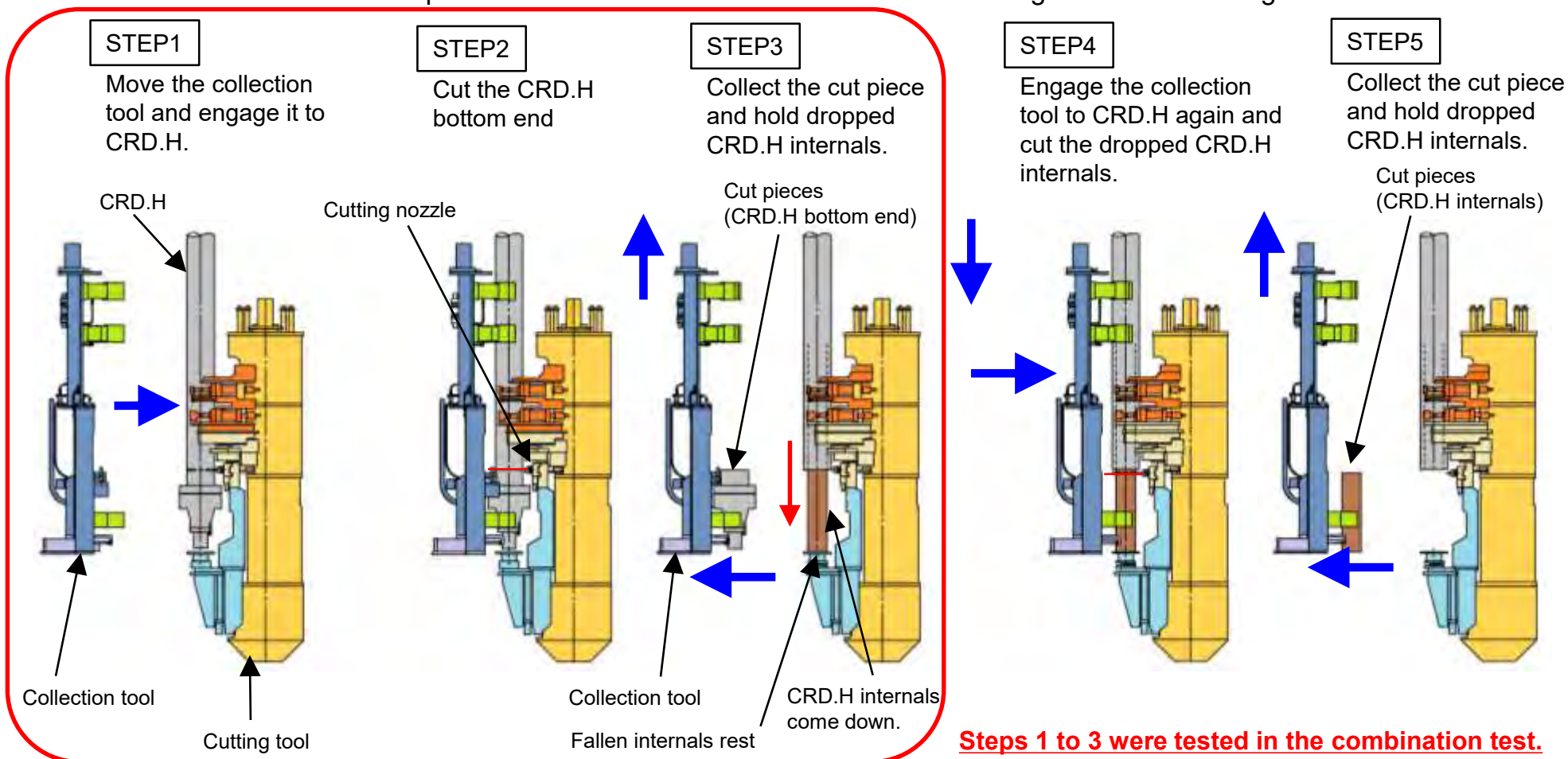

6. Implementation details of this project

6.2. Implementation details

2) Development of Element Technology for Retrieval Device Installation

(2) Development of Interference Object Removal during Fuel Debris Retrieval

a. Method to remove interfering objects by the fuel debris retrieval device designed for the top access method

The results of the elemental tests are described below.

No.	Test item	Test procedures	Evaluation criteria	Test results	Notes
1	CRD.H cutting test tool positioning	Locate the cutting tool at a predetermined CRD.H cutting position using the auxiliary arm.	The cutting tool shall be able to be located at a predetermined position and the CRD.H be grabbed by it.	It was demonstrated that the cutting tool could be installed through the hole in the RPV bottom head and grab the CRD.H.	
2	Collection tool positioning	Locate the collection tool by the auxiliary arm at a predetermined position and have it grab the cut piece of the CRD.H after cutting to prevent falling.	The collection tool shall be able to be located at a predetermined position by the support of the auxiliary arm and the like and the CRD.H be grabbed by it.	It was demonstrated that the collection tool could be installed through the hole in the RPV bottom head and grab the CRD.H.	
3	Cutting by the cutting tool	Cut the CRD.H by the cutting tool. (AWJ, laser cutting)	The CRD.H shall be able to be cut at a planned position by AWJ or laser.	It was demonstrated that the CRD.H could be cut by AWJ mounted on the cutting tool while the cut off part was held by the cutting tool.	
4	Transportation by the collection tool	Grip and transport the cut piece of the CRD.H separated from its main body to the proximity of the UC.	Cut pieces of CRD.Hs shall be able to be held by the collection tool and transported to the proximity of the UC.	It was demonstrated that the cut piece of the CRD.H could be grabbed and transported to the proximity of the UC by the collection tool.	
5	Putting cut piece in the UC by the collection arm	Pick the cut piece of the CRD.H up from the collection tool and put it in the UC by the collection arm.	The cut piece of the CRD.H shall be able to be picked up from the collection tool and put in the UC by the collection arm.	It was demonstrated that the cut piece held by the collection tool could be picked up and put in the UC by the collection arm.	
6	Remote monitoring test	Install cameras in suitable positions so that the operation can be monitored remotely.	The above operations shall be able to be performed remotely.	The above operations were performed basically remotely.	

6. Implementation details of this project





6.2. Implementation details

2) Development of Element Technology for Retrieval Device Installation

(2) Development of Interference Object Removal during Fuel Debris Retrieval

a. Method to remove interfering objects by the fuel debris retrieval device designed for the top access method

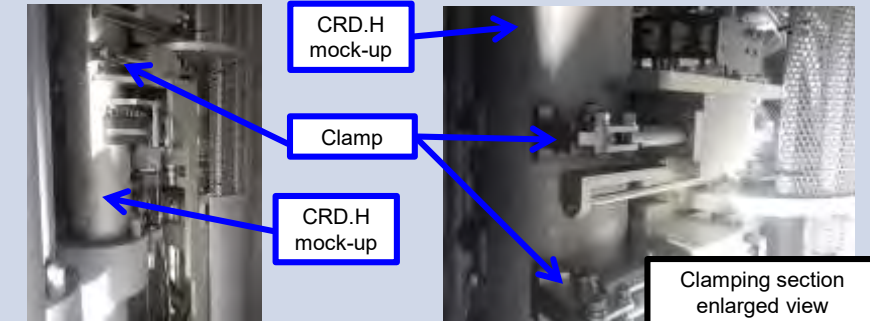
Operation time was measured during the element tests and used to analyze throughput. The result of the operation time measurement is shown below. : Operation time was measured for these steps.

Work step	Positioning CRD.H cutting tool (Installation time: approx. 39 min) * Suspending and positioning the cutting tool	Positioning auxiliary arm (Installation time: approx. 25 min) * Suspending and positioning the auxiliary arm
Illustration of operation	 <p>Labels: Cutting tool lift, Suspending device, Cutting tool (Moving downward), Hole in the bottom top head, Tool lift section, Tool head section</p>	 <p>Labels: Extendable mechanism, Auxiliary arm (retracted), Cutting tool side, Auxiliary arm (extended)</p>
Work step	Positioning cutting tool and grabbing (Positioning and grabbing time: approx. 59 minutes) * Positioning by the auxiliary arm and grabbing	Positioning CRD.H collection tool (Installation time: approx. 33 min) * Suspending and positioning the collection tool
Illustration of operation	 <p>Labels: CRD.H mock-up, Clamp, CRD.H mock-up, Clamping section enlarged view</p>	 <p>Labels: Collection tool (Moving downward), Cutting tool (at operating position)</p>

6. Implementation details of this project

6.2. Implementation details

2) Development of Element Technology for Retrieval Device Installation

(2) Development of Interference Object Removal during Fuel Debris Retrieval

a. Method to remove interfering objects by the fuel debris retrieval device designed for the top access method

Operation time was measured during the element tests and used to analyze throughput. The result of the operation time measurement is shown below. : Operation time was measured for these steps.

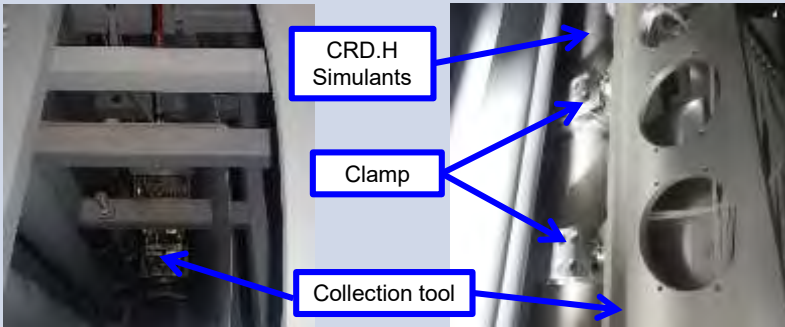
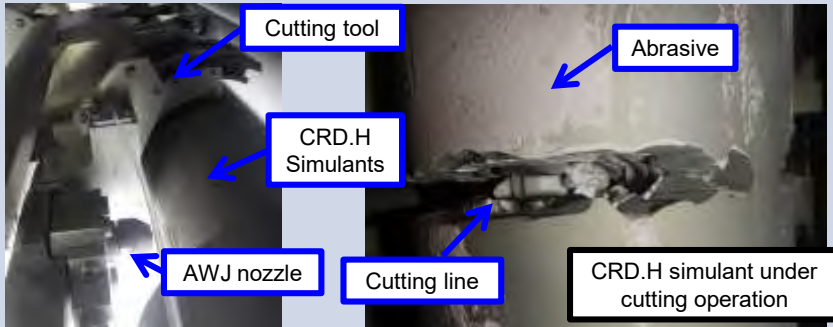
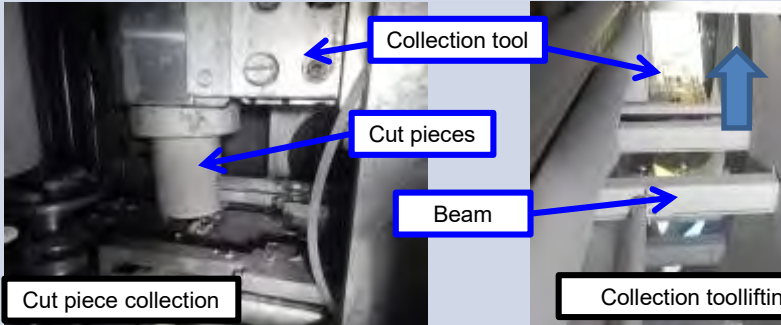
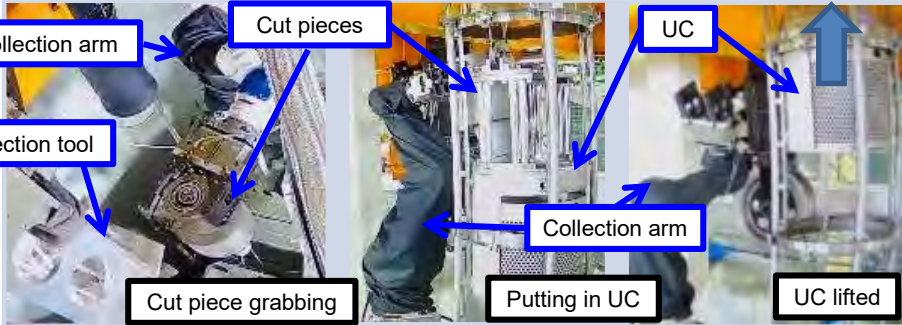
Work step	Positioning collection tool and grabbing (Positioning and grabbing time: approx. 29 minutes)	Cutting CRD.H (Cutting time: approx. 271 min)
Illustration of operation	 <p>CRD.H Simulants</p> <p>Clamp</p> <p>Collection tool</p>	 <p>Cutting tool</p> <p>Abrasive</p> <p>CRD.H Simulants</p> <p>AWJ nozzle</p> <p>Cutting line</p> <p>CRD.H simulant under cutting operation</p>
Work step	Collecting cut pieces and lifting collection tool (Cut piece collection and collection tool lifting time: approx. 55 min)	Putting cut piece in the UC (Time needed to grab cut piece and put in UC by collection arm: approx. 49 min)
Illustration of operation	 <p>Collection tool</p> <p>Cut pieces</p> <p>Beam</p> <p>Cut piece collection</p> <p>Collection tool lifting</p>	 <p>Collection arm</p> <p>Cut pieces</p> <p>UC</p> <p>Collection tool</p> <p>Collection arm</p> <p>Cut piece grabbing</p> <p>Putting in UC</p> <p>UC lifted</p>

6. Implementation details of this project

6.2. Implementation details

2) Development of Element Technology for Retrieval Device Installation

(2) Development of Interference Object Removal during Fuel Debris Retrieval

a. Method to remove interfering objects by the fuel debris retrieval device designed for the top access method

Measured operation time was summarized by the type of element tests.

No.	Test item	Test procedure	Operation time of each step	Total operation time (per cycle)	Notes
1	CRD.H cutting test Cutting tool positioning	Locate the cutting tool at a planned CRD.H cutting position and have it grab the CRD.H using the auxiliary arm.	<ul style="list-style-type: none"> • Cutting tool positioning: approx. 39 min • Auxiliary arm positioning: approx. 25 min • CRD.H grabbing: approx. 59 min 	Total operation time: approx. 2.1 hours	
2	Collection tool positioning	Locate the collection tool by the auxiliary arm at a predetermined position and have it grab the cut piece of the CRD.H after cutting to prevent falling.	<ul style="list-style-type: none"> • Auxiliary arm withdrawal: approx. 25 min • Collection tool positioning: approx. 33 min • Auxiliary arm positioning: approx. 25 min • Grabbing for fall prevention: approx. 29 min 	Total operation time: approx. 1.9 hours	
3	Cutting by the cutting tool	Cut the CRD.H by the cutting tool. (AWJ, laser cutting)	<ul style="list-style-type: none"> • Auxiliary arm withdrawal: approx. 18 min • Cutting by AWJ: approx. 271 min 	Total operation time: approx. 4.9 hours	Operation time to cut a CDR.H simulant with heavy damage (SUS multi-concentric cylinders with zirconia)
4	Transportation by the collection tool	Grip and transport the cut piece of the CRD.H separated from its main body to the proximity of the UC.	<ul style="list-style-type: none"> • Auxiliary arm positioning: approx. 35 min • Cut piece removal: approx. 13 min • Collection tool lifting: approx. 42 min 	Total operation time: approx. 1.5 hours	
5	Storing cut piece in the UC by the collection arm	Pick the cut piece of the CRD.H up from the collection tool and put it in the UC by the collection arm.	<ul style="list-style-type: none"> • CRD.H grabbing: approx. 13 min • Putting cut piece in the UC: approx. 36 min 	Total operation time: approx. 0.9 h	

6. Implementation details of this project

6.2. Implementation details

2) Development of Element Technology for Retrieval Device Installation

(2) Development of Interference Object Removal during Fuel Debris Retrieval

a. Method to remove interfering objects by the fuel debris retrieval device designed for the top access method

Issues identified in individual work steps and approached to address the issues are summarized in the table below.

No.	Test item	Test results	Main issues	Action policy*
1	CRD.H cutting test Cutting tool positioning	It was demonstrated that the cutting tool could be installed through the hole in the RPV bottom head and grab the CRD.H.	<ul style="list-style-type: none"> · CRD.H grabbing position accuracy · Method to check CRD.H grabbing condition 	<ul style="list-style-type: none"> · Installing cameras near CRD.H grabbing position (How to install cameras is another issue.) · Obtaining the image of the grabbing section by inserting a camera or fiberscope from under the cutting tool, utilizing the side access method in combination
2	Collection tool positioning	It was demonstrated that the collection tool could be installed through the hole in the RPV bottom head and grab the CRD.H.	<ul style="list-style-type: none"> · CRD.H grabbing position accuracy · Method to check CRD.H grabbing condition 	<ul style="list-style-type: none"> · Devising a cutting method/procedure to reduce cutting work in a narrow place (*) · Reduction of the number of cycles by AWJ · Evaluation of the allowable amount of falling cut pieces that were unpreventable
3	Cutting by the cutting tool	It was demonstrated that the CRD.H could be cut by AWJ mounted on the cutting tool while the cut off part was held by the cutting tool.	<ul style="list-style-type: none"> · Prevention of the damage of the device and surrounding structures by AWJ · Abrasive (abrading agent) spreading and depositing · Reduction of secondary waste amount (1.8 kg/min) · Cut pieces and chips fall prevention 	<ul style="list-style-type: none"> · Devising a method/procedure to reduce removal operation (*) · Reviewing the design of the collection tool
4	Transportation by the collection tool	It was demonstrated that the cut piece of the CRD.H could be grabbed and transported to the proximity of the UC by the collection tool.	<ul style="list-style-type: none"> · Cut piece removal method (The cut piece can be stuck in the cutting tool due to a tilt or the like.) 	<ul style="list-style-type: none"> · Devising a method/procedure to reduce the number of collecting operations (*) · Installing cameras near cut piece grabbing position
5	Storing cut piece in the UC by the collection arm	It was demonstrated that the cut piece held by the collection tool could be picked up and put in the UC by the collection arm.	<ul style="list-style-type: none"> · Cut pieces fall prevention · Method to check the grabbing condition of the cut piece by the collection arm 	<ul style="list-style-type: none"> · Devising a method/procedure to reduce work where monitoring is difficult (*)
6	Remote monitoring test	The above operations were performed basically remotely.	<ul style="list-style-type: none"> · Method to install cameras in a narrow place by remote control 	

Actions with an asterisk () will be set out in the following fiscal year onward. Others will be worked on through future engineering activities.

6. Implementation details of this project

6.2. Implementation details

2) Development of Element Technology for Retrieval Device Installation

(2) Development of Interference Object Removal during Fuel Debris Retrieval

a. Method to remove interfering objects by the fuel debris retrieval device designed for the top access method

Main issues identified in the element tests are shown below.

● Method to check CRD.H grabbing position and condition

==> The cutting tool (and collection tool) is surrounded by many CRD.Hs and other structures and the work area is densely populated so that monitoring by cameras is difficult.

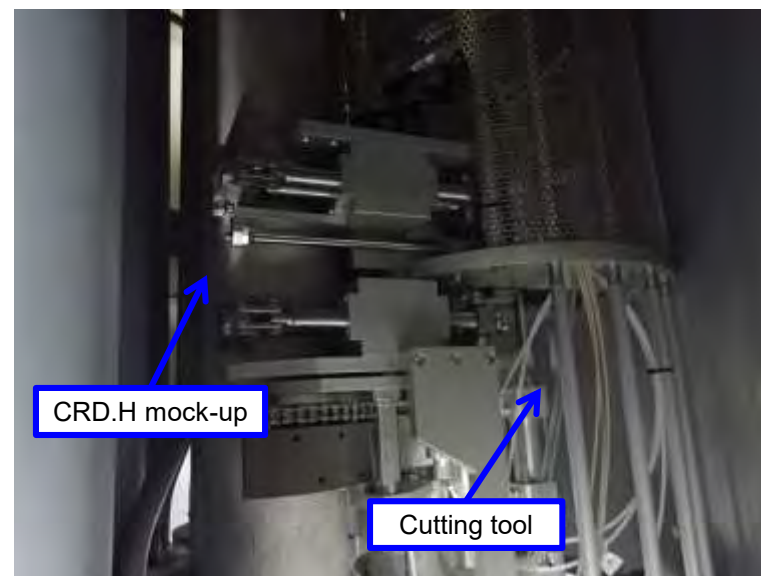
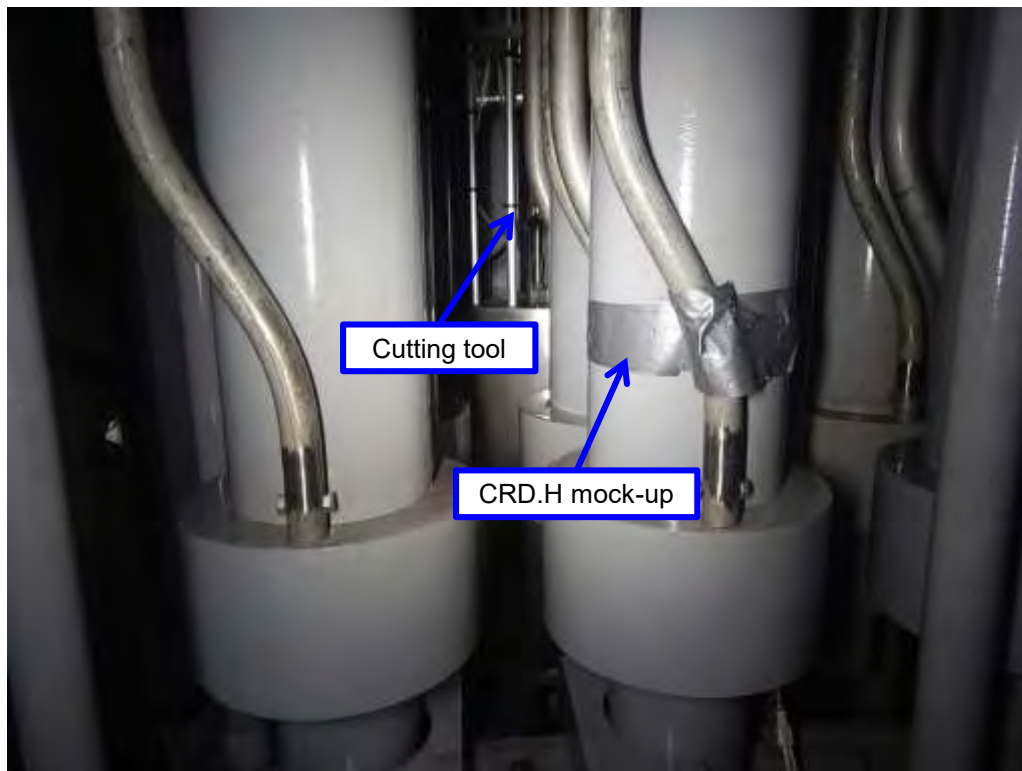

6. Implementation details of this project

6.2. Implementation details

2) Development of Element Technology for Retrieval Device Installation

(2) Development of Interference Object Removal during Fuel Debris Retrieval

a. Method to remove interfering objects by the fuel debris retrieval device designed for the top access method

Main issues identified in the element tests are shown below.

● Damage of the device and surrounding structures by AWJ



Collection tool

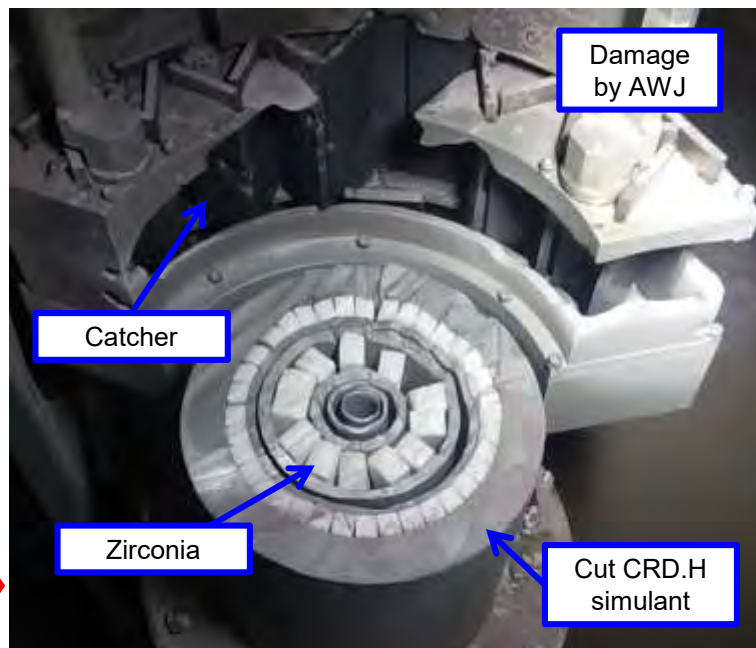

The carbide made abrasive catcher placed at areas hit by the water jet of AWJ to protect the collection tool from damage was heavily damaged.



Unused catcher

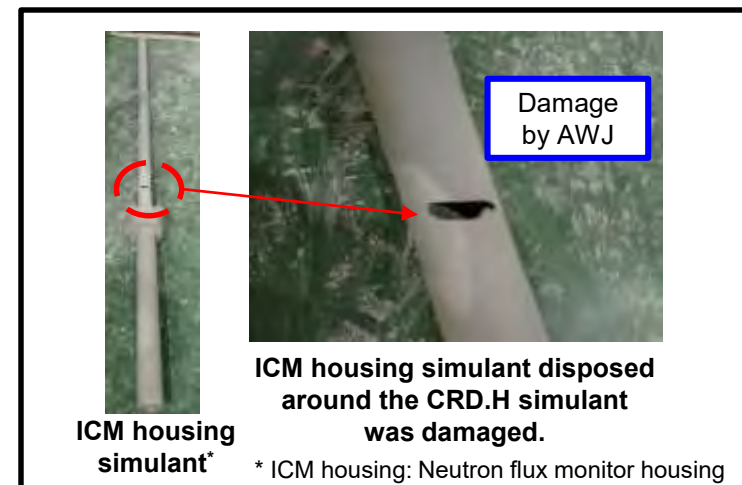

ICM housing simulant*

ICM housing simulant disposed around the CRD.H simulant was damaged.

* ICM housing: Neutron flux monitor housing

6. Implementation details of this project

6.2. Implementation details

2) Development of Element Technology for Retrieval Device Installation

(2) Development of Interference Object Removal during Fuel Debris Retrieval

a. Method to remove interfering objects by the fuel debris retrieval device designed for the top access method

Main issues identified in the element tests are shown below.

- Abrasive (abrading agent) spreading and depositing (abrasive feed rate: 1800g/min)
=> The deposit of abrasive in the driving mechanism of the device causes a malfunction.
- CRD.H internals falling (such as broken pieces of zirconia)
=> It is impossible that the receiving part of the cutting tool hold all of the cut piece.



Deposit on the flange



Deposit in the collection tool driving mechanism



Fall on the bottom of the test tank

6. Implementation details of this project

6.2. Implementation details

2) Development of Element Technology for Retrieval Device Installation

(2) Development of Interference Object Removal during Fuel Debris Retrieval

a. Method to remove interfering objects by the fuel debris retrieval device designed for the top access method

Conceptual study was performed on a collection method used in predictable emergencies.

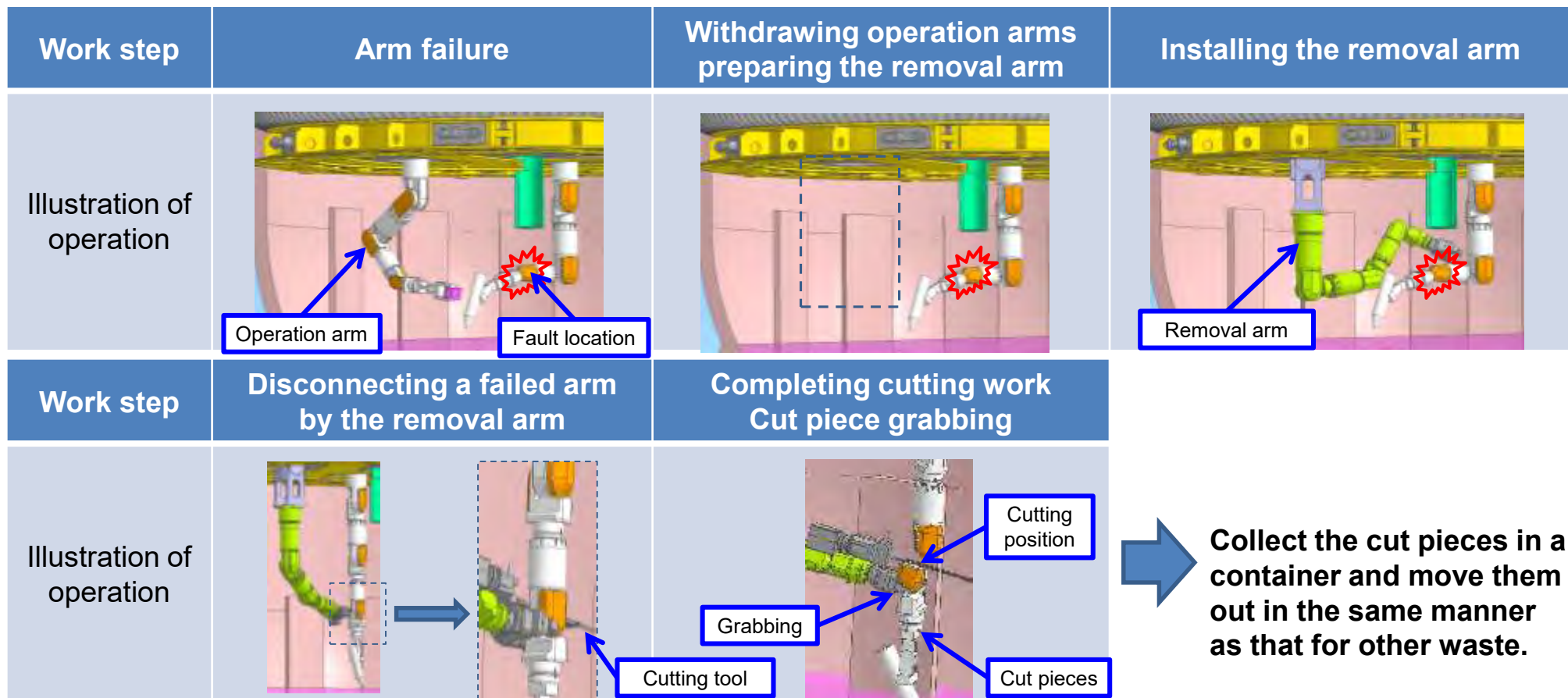

Collect the cut pieces in a container and move them out in the same manner as that for other waste.

6. Implementation details of this project

6.2. Implementation details

2) Development of Element Technology for Retrieval Device Installation

(2) Development of Interference Object Removal during Fuel Debris Retrieval

a. Method to remove interfering objects by the fuel debris retrieval device designed for the top access method

The top access and side access combined method was studied, in which fuel debris and interfering objects would be cut and removed by the top access method and transported out of the reactor by the transportation route of side access method.

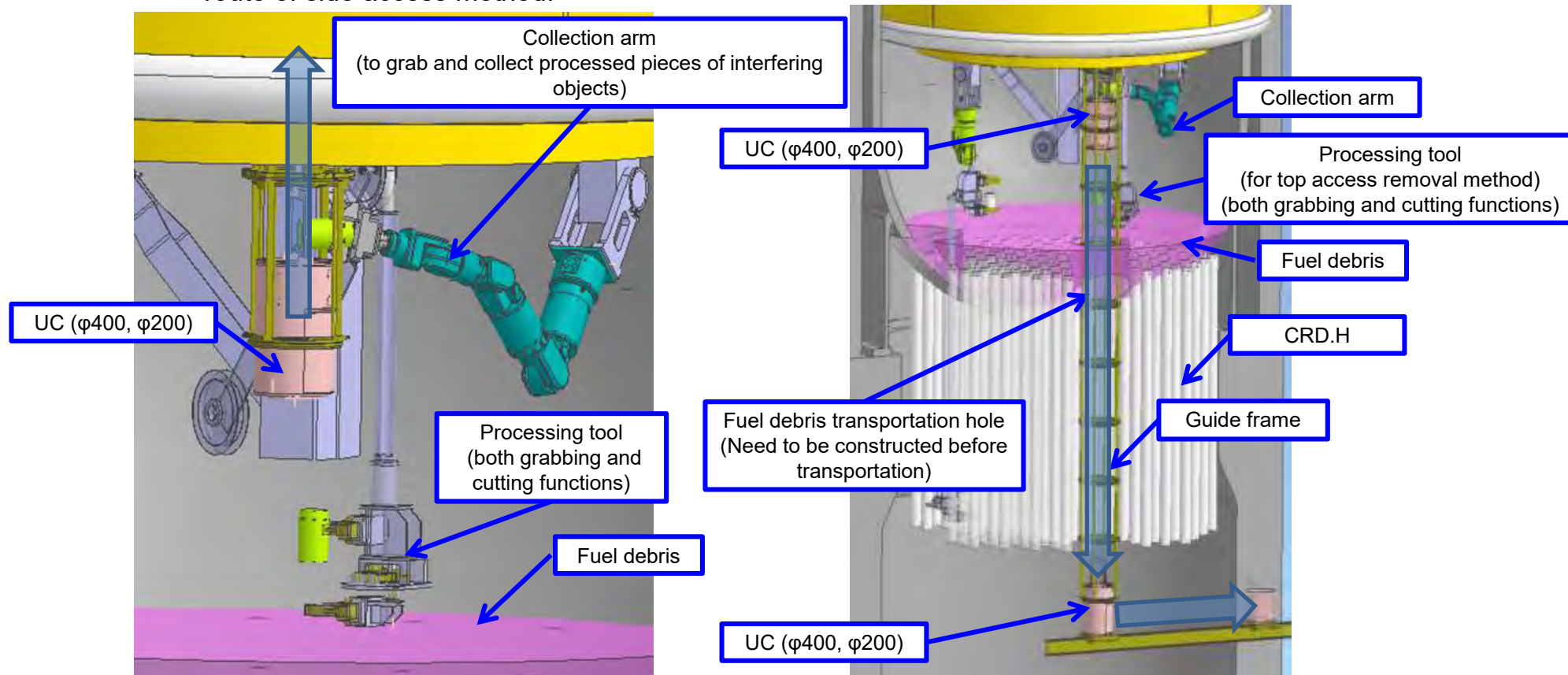

Illustration of transportation utilizing only the top access method

Illustration of transportation utilizing the top and side access methods in combination

6. Implementation details of this project

6.2. Implementation details

2) Development of Element Technology for Retrieval Device Installation

(2) Development of Interference Object Removal during Fuel Debris Retrieval

a. Method to remove interfering objects by the fuel debris retrieval device designed for the top access method

Processing steps of the top and side access combined interfering objects removal method were studied.*

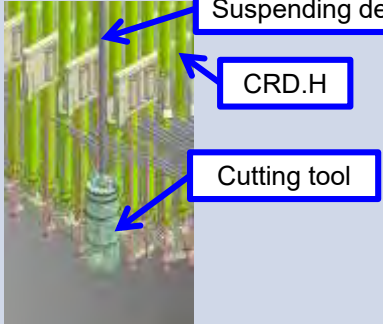
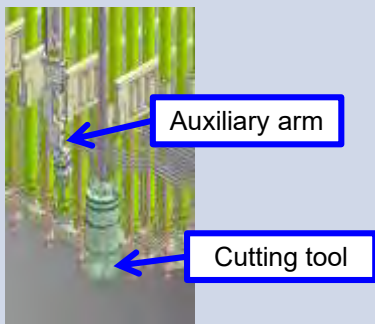
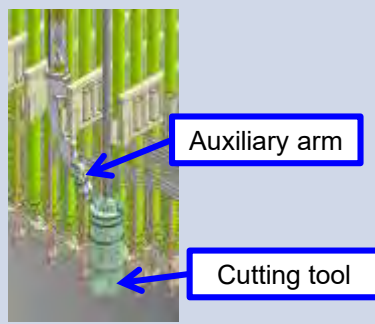
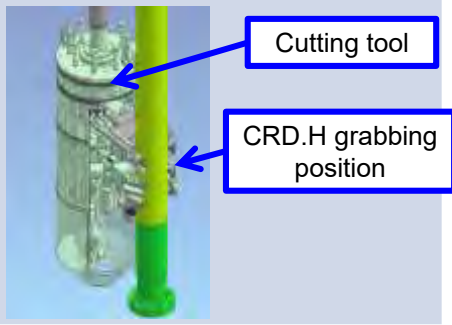
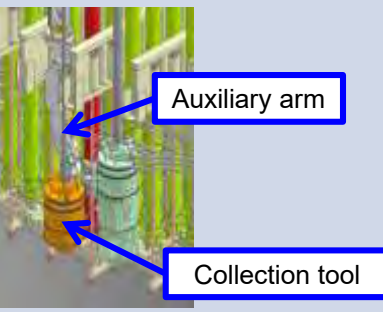
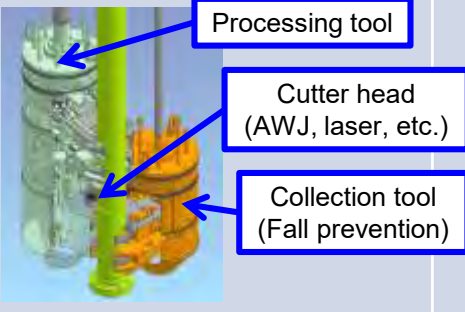
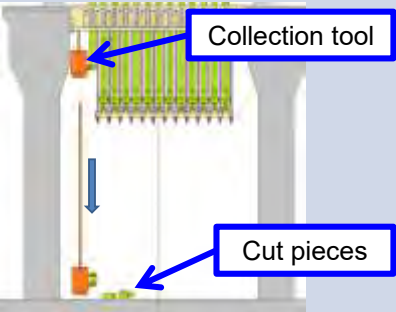
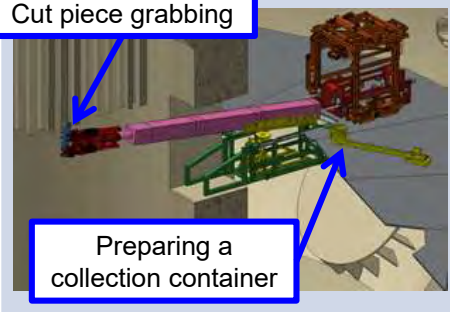
Work step	CRD.H processing tool installation	Installing auxiliary arm	Positioning the processing tool by the auxiliary arm	Grabbing CRD.H by the processing tool
Illustration of operation	 <p>Suspending device CRD.H Cutting tool</p>	 <p>Auxiliary arm Cutting tool</p>	 <p>Auxiliary arm Cutting tool</p>	 <p>Cutting tool CRD.H grabbing position</p>
Work step	Positioning collection tool, Grabbing CRD.H (fall prevention)	Cutting CRD.H by the processing tool	Placing cut pieces in the pedestal bottom temporarily	Grabbing cut pieces utilizing the side access method
Illustration of operation	 <p>Auxiliary arm Collection tool</p>	 <p>Processing tool Cutter head (AWJ, laser, etc.) Collection tool (Fall prevention)</p>	 <p>Collection tool Cut pieces</p>	 <p>Cut piece grabbing Preparing a collection container</p>

*: This study was performed based on the assumption that CRD.Hs removal would be carried out after the completion of fuel debris retrieval by the side access method.

6. Implementation details of this project

6.2. Implementation details

2) Development of Element Technology for Retrieval Device Installation

(2) Development of Interference Object Removal during Fuel Debris Retrieval

a. Method to remove interfering objects by the fuel debris retrieval device designed for the top access method

Processing steps of the top and side access combined interfering objects removal method were studied.*

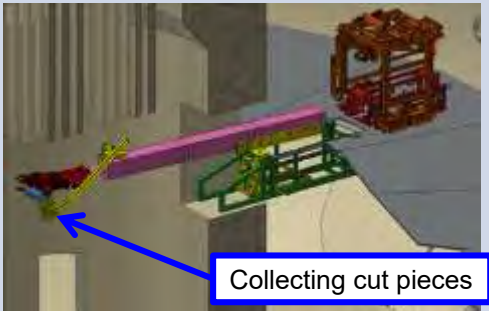
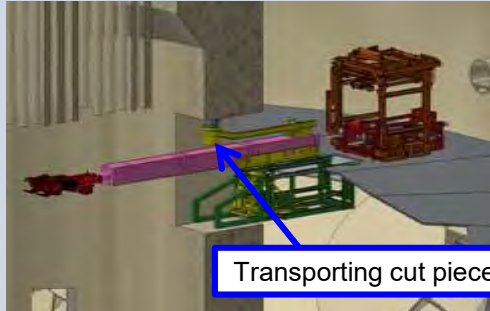
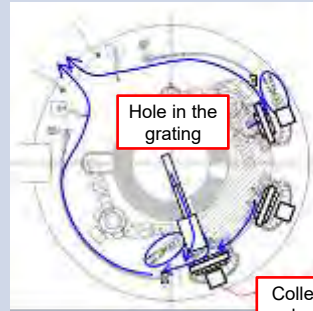
Work step	Collecting cut pieces in a collection container	Transporting cut pieces out from inside the pedestal	Transporting cut pieces out from inside the PCV
Illustration of operation	 Collecting cut pieces	 Transporting cut pieces	 Hole in the grating Collection device

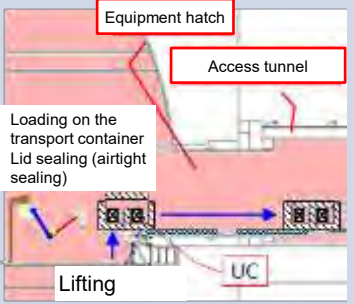
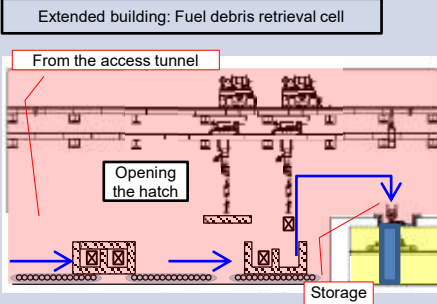
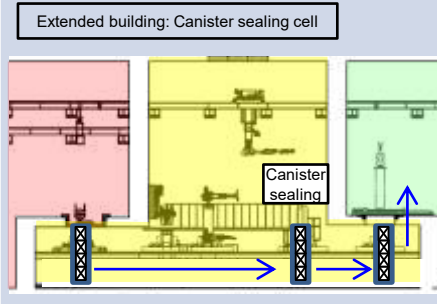
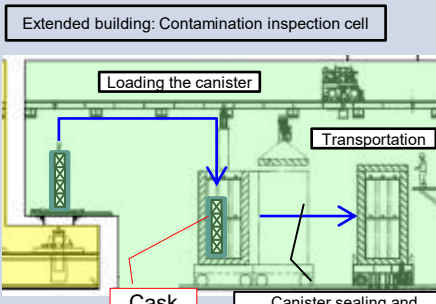
Work step	Transportation (from equipment hatch to access tunnel)	Transportation (from red area to yellow area)	Transportation (from yellow area to R/B outside)	
Illustration of operation	 Equipment hatch Access tunnel Loading on the transport container Lid sealing (airtight sealing) Lifting UC	 Extended building: Fuel debris retrieval cell From the access tunnel Opening the hatch Storage canister	 Extended building: Canister sealing cell Canister sealing	 Extended building: Contamination inspection cell Loading the canister Transportation Cask Canister sealing and contamination inspection

*: This study was performed based on the assumption that CRD.Hs removal would be carried out after the completion of fuel debris retrieval by the side access method.

6. Implementation details of this project

6.2. Implementation details

2) Development of Element Technology for Retrieval Device Installation

(2) Development of Interference Object Removal during Fuel Debris Retrieval

b. Method for removing interfering objects by the fuel debris retrieval device designed for the side access method

Removal procedures were studied for interfering objects to be removed, in consideration of all operation steps from the PCV inside detailed investigation, sampling of fuel debris in the PCV, to fuel debris retrieval.

: Element tests were performed.

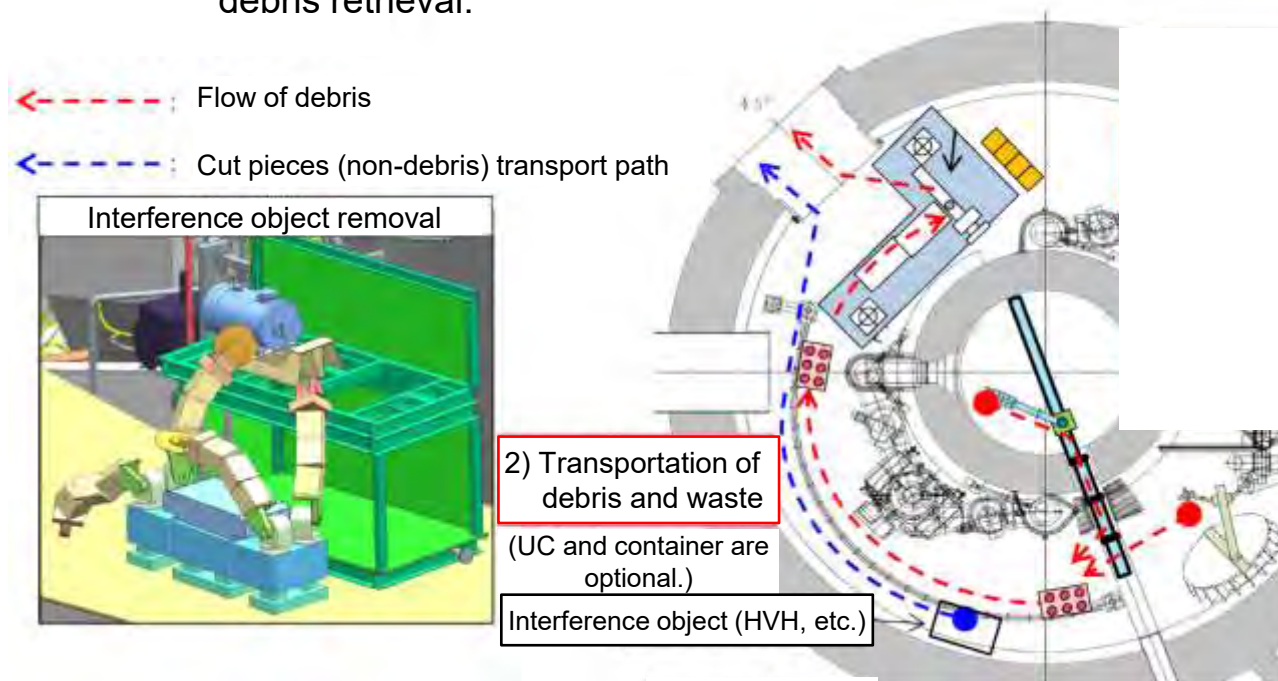

Interfering objects removal operation procedures (Idea)

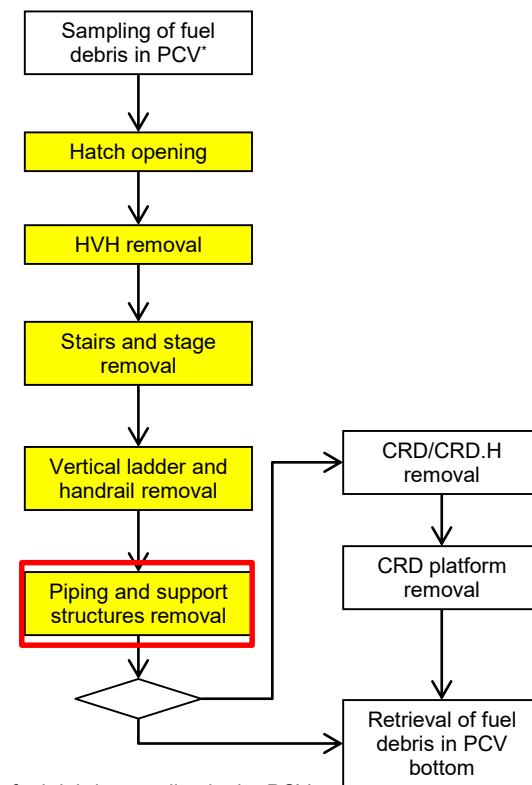

The procedures shown on the right were considered practical to gain access inside the pedestal for fuel debris retrieval.

It will be determined later which should be prioritized between the following two operations after establishing an access route into the pedestal: small scale fuel debris retrieval operation in the bottom of the PCV utilizing the established access route, or large scale fuel debris retrieval operation after removing interfering objects in the pedestal.

*: The removal of structures outside the pedestal was not considered necessary for fuel debris sampling in the PCV.

6. Implementation details of this project

6.2. Implementation details

2) Development of Element Technology for Retrieval Device Installation

(2) Development of Interference Object Removal during Fuel Debris Retrieval

b. Method for removing interfering objects by the fuel debris retrieval device designed for the side access method

Removal procedures were studied for interfering objects to be removed, in consideration of all operation steps from the PCV inside detailed investigation, sampling of fuel debris in the PCV, to fuel debris retrieval.

: Element tests were performed.

Interfering objects removal operation procedures (Idea)

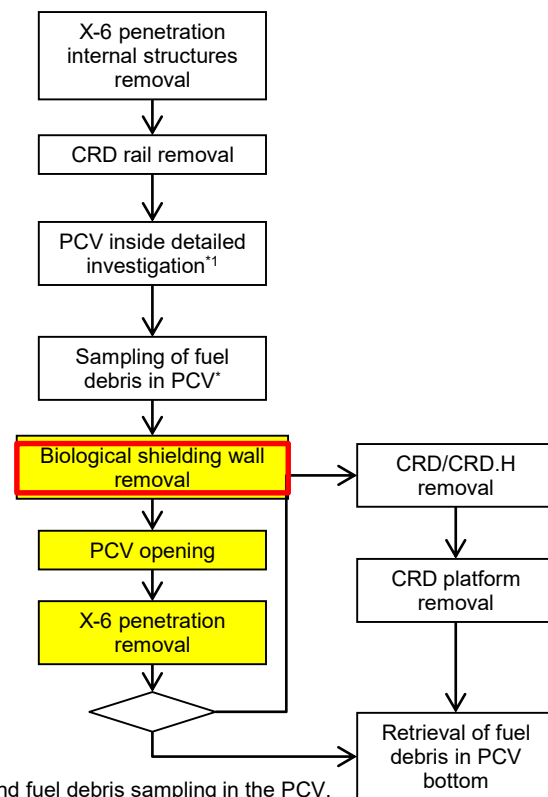
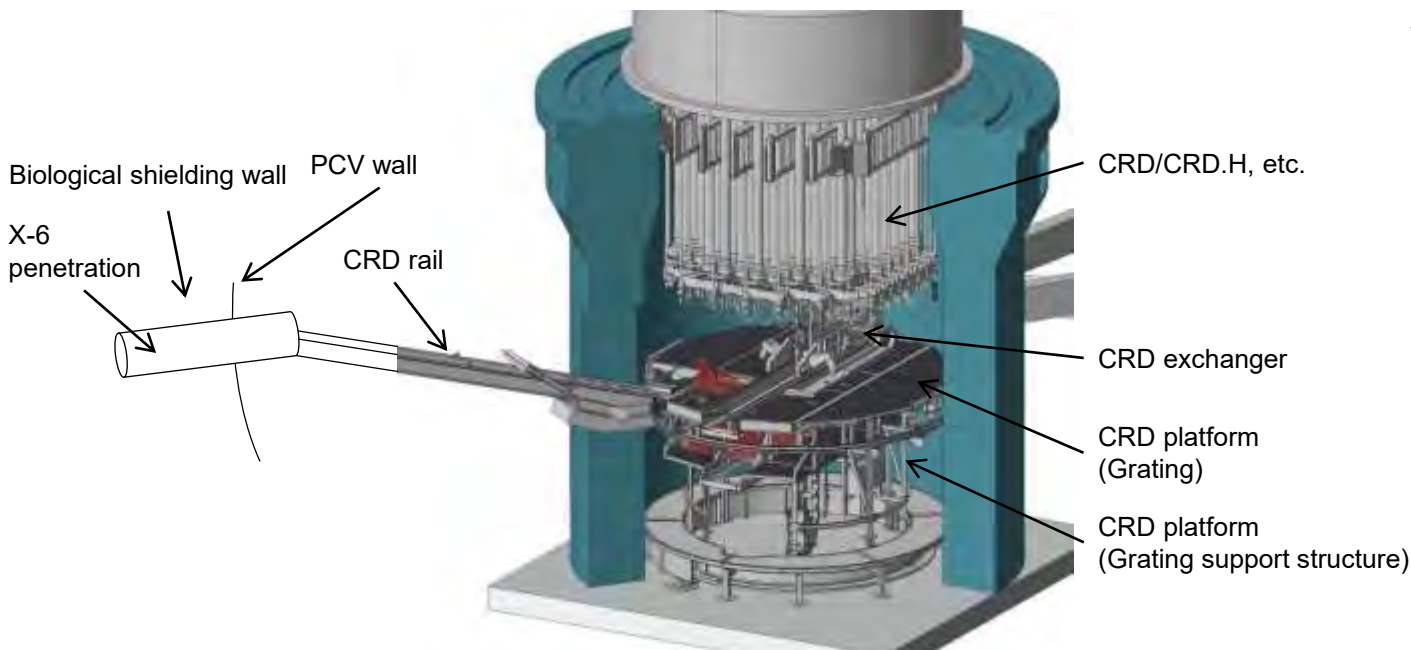

The procedures shown on the right were considered practical to gain access inside the pedestal for fuel debris retrieval.

It will be determined later which should be prioritized between the following two operations after establishing an access route into the pedestal: small scale fuel debris retrieval operation in the bottom of the PCV utilizing the established access route, or large scale fuel debris retrieval operation after removing interfering objects in the pedestal.

*: The use of an arm-type mechanism was considered for PCV inside detailed investigation and fuel debris sampling in the PCV.

6. Implementation details of this project

6.2. Implementation details

2) Development of Element Technology for Retrieval Device Installation

(2) Development of Interference Object Removal during Fuel Debris Retrieval

b. Method for removing interfering objects by the fuel debris retrieval device designed for the side access method

Interfering objects that need to be removed were listed along with relevant information. : Element tests were performed.

* Degree of difficulty scores in the table are based on relative evaluation

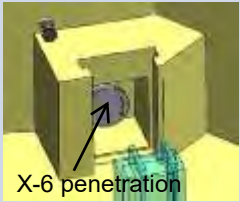
No.	Interfering objects	Outline specifications	Proposed processing methods	Examples of removal methods	Degree of difficulty of operation*	Notes
1	Biological shielding wall 	Main material Reinforced concrete	Core boring Wire saw	<ol style="list-style-type: none"> ① Cut out and remove concrete around X-6 penetration. ② Install a shielding wall. ③ Construct an opening in the BSW using core boring and an overlapping-hole method. ④ Extracted cores are transported through the sleeve. 	Medium	
2	X-6 penetration	Main material SA516 Gr. 70	Core boring Thermal cutting (Laser, gas)	<ol style="list-style-type: none"> ① Install an airtight and radiation shielding cell that encompasses X-6 penetration outside the BSW. ② Remove concrete around X-6 penetration by coring. ③ Cut the exposed concrete core in a longitudinal direction and remove it. ④ Cut the exposed X-6 penetration sleeve from outside using trim cutting. ⑤ Cut the PCV wall around X-6 penetration. 	Low	When adopting the method to remove X-6 penetration, it will be cut and removed together with the PCV wall. As to the method to utilize the through-hole of X-6 penetration, its internal structures are considered to have been removed when a PCV inside detailed investigation was conducted.
3	PCV wall	Main material SA515 Gr. 70	Thermal cutting (Laser, gas)	<ol style="list-style-type: none"> ① Install inflate seals between the inner surface of the BSW and the PCV. ② Mark cutting lines on the wall. ③ Cut the wall along the cutting lines by laser. ④ Put cut pieces in a container and move them out. 	Low	

6. Implementation details of this project

6.2. Implementation details



2) Development of Element Technology for Retrieval Device Installation

(2) Development of Interference Object Removal during Fuel Debris Retrieval

b. Method for removing interfering objects by the fuel debris retrieval device designed for the side access method

Interfering objects that need to be removed were listed along with relevant information.

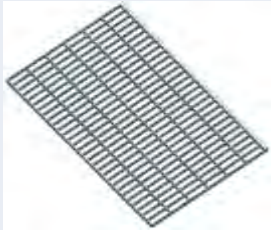
* Degree of difficulty scores in the table are based on relative evaluation

No.	Interfering objects	Outline specifications	Proposed processing methods	Examples of removal methods	Degree of difficulty of operation*	Notes
4	CRD rail 	Main material SUS+SS	Disc cutter, sabre saw, thermal cutting (laser, gas)	① Cut by a disc cutter or the like. ② Put cut pieces in a container and move them out (through the equipment hatch).	Medium	This structure is considered to have been removed when the PCV inside detailed investigation was conducted.
5	Grating 	Main material SS	Disc cutter, sabre saw	① Cut by a disc cutter or the like. ② Put cut pieces in a container and move them out (through the equipment hatch).	Low	
6	Grating support structure 	Main material SS	Disc cutter, sabre saw	① Cut by a disc cutter or the like. ② Put cut pieces in a container and move them out (through the equipment hatch).	Low	

6. Implementation details of this project

6.2. Implementation details



2) Development of Element Technology for Retrieval Device Installation

(2) Development of Interference Object Removal during Fuel Debris Retrieval

b. Method for removing interfering objects by the fuel debris retrieval device designed for the side access method

Interfering objects that need to be removed were listed along with relevant information.

* Degree of difficulty scores in the table are based on relative evaluation

No.	Interfering objects	Outline specifications	Proposed processing methods	Examples of removal methods	Degree of difficulty of operation*	Notes
7	Equipment hatch and shield plug 	Main material · Shield plug: Reinforced concrete · Hatch: SS	Shield plug: Wire saw Hatch: Disc cutter	① Cut the shield plug by a wire saw or the like. (Push-cutting) ② Cut the hatch by a disc cutter or the like. ③ Put cut pieces in a container and move them out.	Medium	Detailed procedure will be considered when the connection method with the cell is engineered.
8	Heating Ventilating Handlina Unit (HVH) 	Main material SS	Disc cutter, sabre saw, hydraulic cutter	① Cut the exterior panel by a disc cutter. ② A method used to cut the internal equipment is to be selected separately (among suitable methods). ③ Put cut pieces in a container and move them out (through the equipment hatch).	High	· Cutting of ducts in high place · Operation in a narrow place · Cutting of compound and complex shape objects (Tests were performed in previous fiscal years.)
9	Airlock front stairs and stage 	Main material SS	Disc cutter, sabre saw	① Cut by a disc cutter or the like. ② Put cut pieces in a container and move them out (through the equipment hatch).	Low	

6. Implementation details of this project

6.2. Implementation details



2) Development of Element Technology for Retrieval Device Installation

(2) Development of Interference Object Removal during Fuel Debris Retrieval

b. Method for removing interfering objects by the fuel debris retrieval device designed for the side access method

Interfering objects that need to be removed were listed along with relevant information. : Element tests were performed.

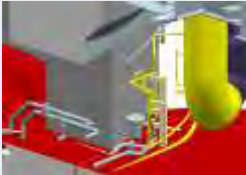
* Degree of difficulty scores in the table are based on relative evaluation

No.	Interfering objects	Outline specifications	Proposed processing methods	Examples of removal methods	Degree of difficulty of operation*	Notes
10	Vertical ladder and handrails 	Main material SS	Disc cutter, sabre saw	① Cut by a disc cutter or the like. ② Put cut pieces in a container and move them out (through the equipment hatch).	Low	
11	Piping and support structures  Back side of PLR piping (underground)  Sump pit and its vicinity (underground)	Main material SS	Disc cutter, sabre saw	① Cut by a disc cutter or the like. ② Put cut pieces in a container and move them out (through the equipment hatch).	Medium to high	Although cutting pipes is not difficult work by itself, gaining access to pipes laid out in a difficult-to-reach place or highly populated area and how to arrange the operation procedures are challenging.

6. Implementation details of this project

6.2. Implementation details

2) Development of Element Technology for Retrieval Device Installation

(2) Development of Interference Object Removal during Fuel Debris Retrieval

b. Method to remove interfering objects by the fuel debris retrieval device designed for the side access method

(i) Method and procedure to remove interfering objects outside the pedestal

Equipment outside the pedestal is included in the group of objects that are to be removed by methods common to the top and side access methods. For said reason, and in consideration of difficulty of operation, etc., elemental tests are planned for the removal of structures near the personnel access port (such as piping and support structures).

- Purpose of development
 - Feasibility demonstration of cutting work in a narrow place
 - Feasibility demonstration of processing methods that take into consideration object fall prevention measures
- Issues to be solved
 - Cutting methods applicable to narrow places
 - Operability of remote operation
- Expected outcome
 - Verification of the feasibility of installing equipment in a narrow place
 - Feasibility of the entire operation process from cutting target interfering objects, putting the cut pieces of them in containers, to transporting the containers from the B1 floor to the 1st floor
 - Study of throughput.

6. Implementation details of this project

6.2. Implementation details

2) Development of Element Technology for Retrieval Device Installation

(2) Development of Interference Object Removal during Fuel Debris Retrieval

b. Method for removing interfering objects by the fuel debris retrieval device designed for the side access method

(i) Method and procedure to remove interfering objects outside the pedestal

The illustration of the element test to evaluate the removal of piping and support structures outside the pedestal is shown below.

Reasons of the selection of sections reproduced in the test mock-up

- ① It is located near the platform. (To build a platform to the pedestal)
- ② The first floor is crowded due to the presence of the MS piping.
- ③ Underground floors are crowded due to the presence of the PLR pump.

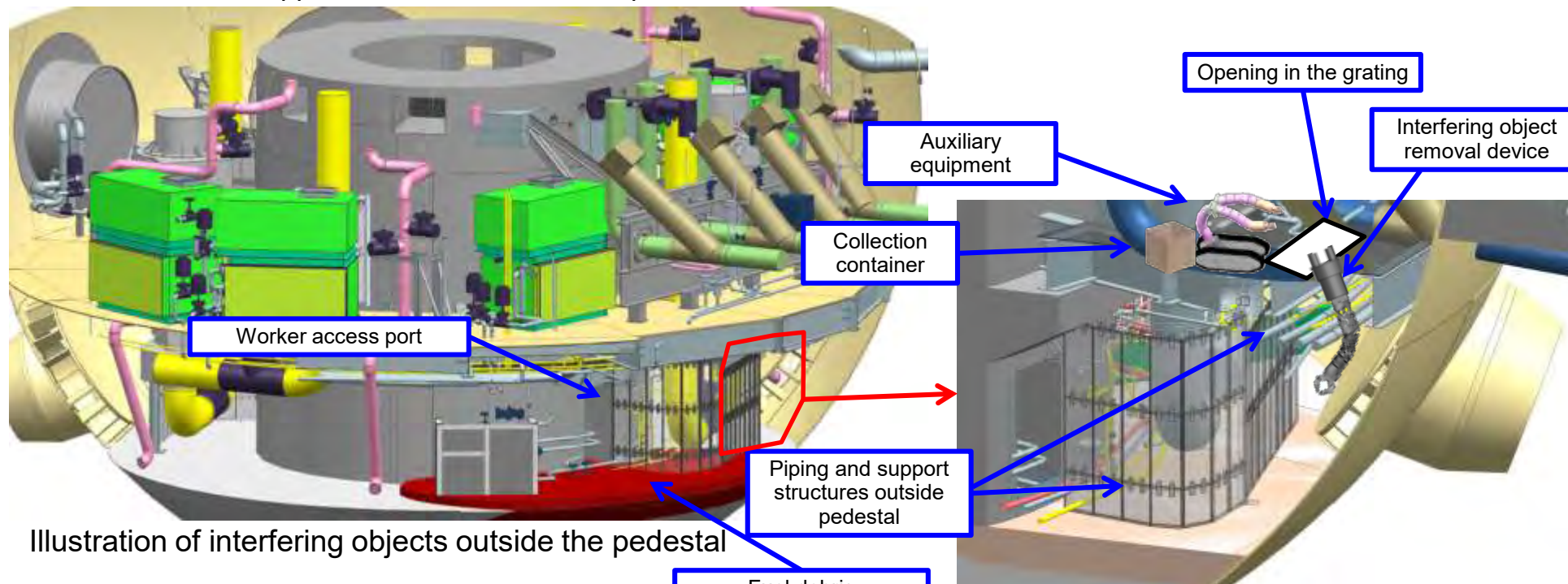

Illustration of interfering objects outside the pedestal

Illustration of the element test for studying the removal of piping and support structures outside the pedestal

: Scope of simulation for element tests

6. Implementation details of this project

6.2. Implementation details

2) Development of Element Technology for Retrieval Device Installation

(2) Development of Interference Object Removal during Fuel Debris Retrieval

b. Method to remove interfering objects by the fuel debris retrieval device designed for the side access method

(i) Method and procedure to remove interfering objects outside the pedestal

The overview of the development and the procedures is provided.

No.	Steps of the removal process of interfering objects outside the pedestal	Contents of activities and the purpose of tests (Confirmation items)	Element test	Notes
1	Construction of an opening to the basement floor	A grating cutting device shall be able to be installed at predetermined locations, and openings to the basement floor shall be able to be constructed by cutting the grating by the device while fall prevention measures are implemented for the cut pieces of the grating.	○	
2	Processing of interfering objects in access routes to the basement floor	Special device shall be able to be installed at a desired location so that the arms of the device can be manipulated to interfering objects in a narrow place and cut and remove them while fall prevention measures are implemented for cut pieces.	○	
3	Collection of interfering objects in access routes to the basement floor	Cut pieces of interfering objects shall be able to be put in a collection container, and the container shall be able to be transported above the grating and transferred to the transportation route to outside of the PCV.	○	
4	Installation of the interfering object removal device outside the pedestal	<ul style="list-style-type: none"> The special cutting and removal unit shall be able to be installed from above the grating, and the platform of the device shall be able to be built above the jet deflector. The operation arm shall be able to be installed on the platform from above the grating. 	○	
5	Processing of interfering objects	The arms of the device shall be able to be manipulated to interfering objects in a narrow place and cut and remove them while fall prevention measures are implemented for cut pieces.	○	
6	Removal of interfering objects	Cut pieces of interfering objects shall be able to be put in a collection container, and the container shall be able to be transported above the grating and transferred to the transportation route to outside of the PCV.	○	

6. Implementation details of this project

6.2. Implementation details

2) Development of Element Technology for Retrieval Device Installation

(2) Development of Interference Object Removal during Fuel Debris Retrieval

b. Method for removing interfering objects by the fuel debris retrieval device designed for the side access method

(i) Method and procedure to remove interfering objects outside the pedestal

Work steps of the removal of interfering objects outside the pedestal were studied to identify necessary functions for the operation and potential issues.

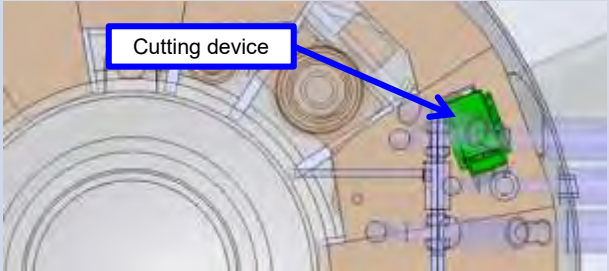
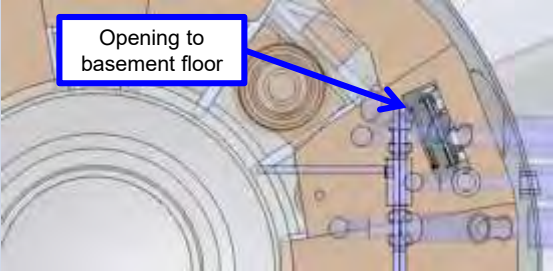
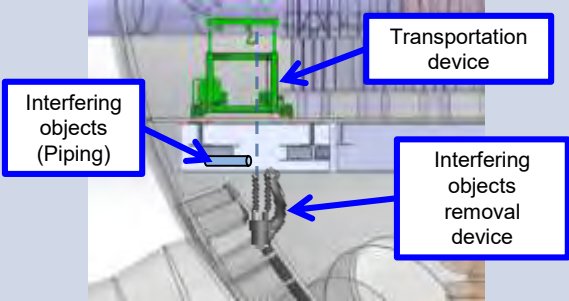
Work step	A. Preparing for the construction of an opening to the basement floor (Carrying in the grating cutting device)	B. Constructing an opening to the basement floor (Cutting the grating)	C. Installing the device to cut and remove interfering objects in access routes to the basement floor
Illustration of operation	 <p>Cutting device</p>	 <p>Opening to basement floor</p>	 <p>Transportation device</p> <p>Interfering objects (Piping)</p> <p>Interfering objects removal device</p>
Description	Installing the grating cutting device to prepare for opening construction	Cutting the grating to construct openings to the basement floor	Installing the device to cut and remove interfering objects in access routes to the basement floor
Functional requirements	Cutting device shall be able to be installed at the planned opening construction position, and its cutting head shall be able to be positioned accurately.	Fall prevention measures shall be implemented for the cut pieces of the grating during cutting operation.	Interference object removal equipment shall be able to be carried in through the grating opening.

6. Implementation details of this project

6.2. Implementation details

2) Development of Element Technology for Retrieval Device Installation

(2) Development of Interference Object Removal during Fuel Debris Retrieval

b. Method for removing interfering objects by the fuel debris retrieval device designed for the side access method

(i) Method and procedure to remove interfering objects outside the pedestal

Work steps of the removal of interfering objects outside the pedestal were studied to identify necessary functions for the operation and potential issues.

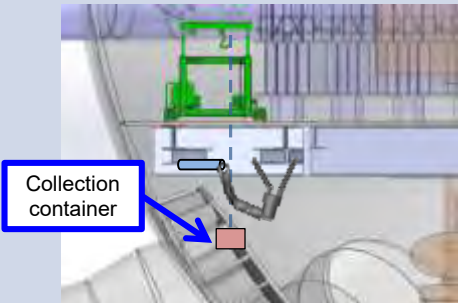
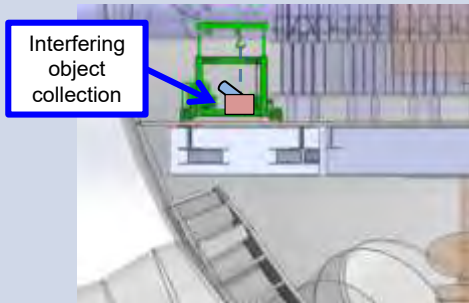
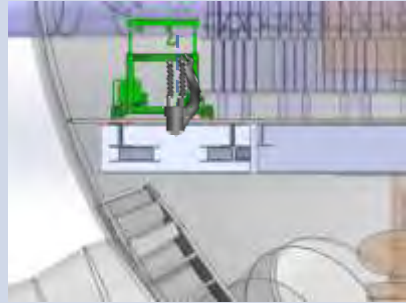
Work step	D. Grabbing and cutting interfering objects	E. Transferring collected interfering objects to the transportation route	F. Uninstalling the device to cut and remove interfering objects in access routes to the basement floor
Illustration of operation			
Description	<p>Manipulating the arms to interfering objects, cutting them into pieces, and putting the cut pieces in a collection container</p>	<p>Transporting the collection container out from the basement floor and transferring them to the transportation route to the outside of the PCV</p>	<p>Uninstalling the cut and removal device and moving it on the grating</p>
Functional requirements	<ul style="list-style-type: none"> · Interfering objects shall be able to be reached. · Interfering objects shall be able to be cut and removed without causing them to fall. · The equipment shall have a cutting tool operable in a narrow place. 	<ul style="list-style-type: none"> · Cut pieces of interfering objects shall be able to be put in a collection container. · The collection containers shall be able to be transported out to above the grating. · The collection container shall be able to be transported. 	<p>The removal device shall be able to be lifted.</p>

6. Implementation details of this project

6.2. Implementation details

2) Development of Element Technology for Retrieval Device Installation

(2) Development of Interference Object Removal during Fuel Debris Retrieval

b. Method for removing interfering objects by the fuel debris retrieval device designed for the side access method

(i) Method and procedure to remove interfering objects outside the pedestal

Work steps of the removal of interfering objects outside the pedestal were studied to identify necessary functions for the operation and potential issues.

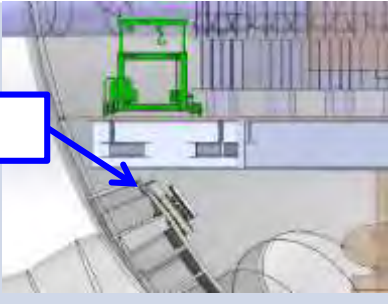
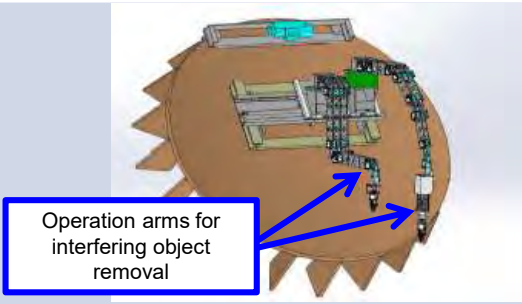
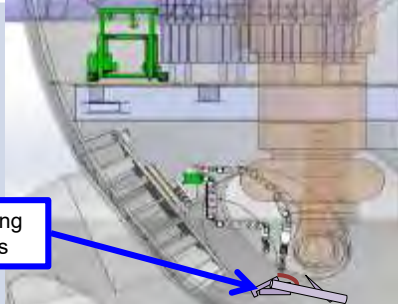
Work step	G. Preparation of the interfering object removal device outside the pedestal	H. Installing operation arms for interfering object removal	I. Manipulating the arms to target interfering objects
Illustration of operation			
Description	<p>Transporting the platform of the removal device from above the grating into the basement floor and installing it at the jet deflector</p>	<p>Carrying the operation arms from above the grating into the basement floor and installing them on the platform</p>	<p>Moving the operation arm tips near interfering objects to be cut and removed</p>
Functional requirements	<ul style="list-style-type: none"> · The platform shall be able to be carried in through the opening in the grating. · The platform shall be able to be installed at the jet deflector. 	<ul style="list-style-type: none"> · The operation arms shall be able to be carried in through the opening in the grating. · The operation arms shall be able to be installed on the platform. 	<p>The arms of the device shall be able to be manipulated to interfering objects.</p>

6. Implementation details of this project

6.2. Implementation details

2) Development of Element Technology for Retrieval Device Installation

(2) Development of Interference Object Removal during Fuel Debris Retrieval

b. Method for removing interfering objects by the fuel debris retrieval device designed for the side access method

(i) Method and procedure to remove interfering objects outside the pedestal

Work steps of the removal of interfering objects outside the pedestal were studied to identify necessary functions for the operation and potential issues.

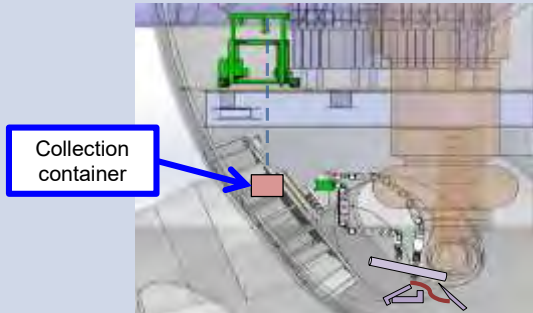
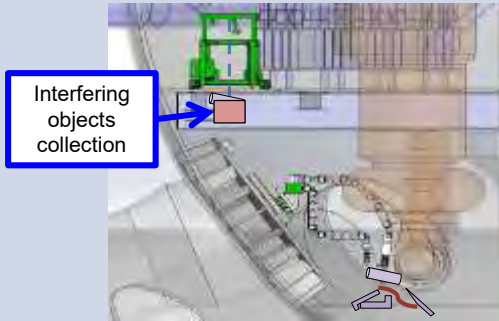
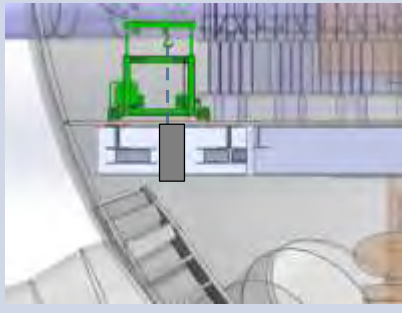
Work step	J. Grabbing and cutting interfering objects	K. Transferring collected interfering objects to the transportation route	L. Uninstalling the device
Illustration of operation			
Description	Collecting cut pieces and putting them in a collection container after cutting	Transporting the collection container out from the basement floor and transferring them to the transportation route to outside of the PCV	Uninstalling the device from the basement floor to above the grating
Functional requirements	<ul style="list-style-type: none"> Interfering objects shall be able to be cut and removed without causing them to fall. The equipment shall have a cutting tool operable in a narrow place. 	<ul style="list-style-type: none"> Cut pieces of interfering objects shall be able to be put in a collection container. The collection container shall be able to be transported out to above the grating. The collection container shall be able to be transported. 	The removal device shall be able to be lifted.

6. Implementation details of this project

6.2. Implementation details

2) Development of Element Technology for Retrieval Device Installation

(2) Development of Interference Object Removal during Fuel Debris Retrieval

b. Method for removing interfering objects by the fuel debris retrieval device designed for the side access method

(i) Method and procedure to remove interfering objects outside the pedestal

Based on the result of the study on work steps of the removal of interfering objects outside the pedestal and on functional requirements for each identified step, specifications of the interfering object removal device were developed and potential issues associated with the operation were identified.

Step	Functional requirements	Basic specifications of the device	Predictable issues during operation
A	Cutting device shall be able to be installed at the planned opening construction position, and its cutting head shall be able to be positioned accurately.	The grating cutting device shall be designed to have dimensions and weight so that it can be installed near planned opening construction positions on the grating (loading capacity of 500 kg/m ²) through the opening of the equipment hatch (1.5 m square)	<ul style="list-style-type: none"> Positioning of the cutting head at the construction position Accidents during the device transportation (fall, stuck, etc.)
B	Fall prevention measures shall be implemented for the cut pieces of the grating during cutting operation.	Fall prevention measures shall be implemented for the cut pieces of the grating.	Fall of cut pieces
C	Interference object removal equipment shall be able to be carried in through the grating opening.	The unit shall be designed to have dimensions so that it can be installed through the opening of the grating, which has a size of 1.9 m x 0.7 m to minimize the number of bar spacings in a radial direction and of bars in a circumferential direction to be removed.	<ul style="list-style-type: none"> Device carrying-in method Accidents during the device carrying-in operation (fall, stuck, etc.)
D	The arms of the device shall be able to be manipulated to interfering objects.	Cutting positions of target interfering objects shall be able to be determined.	Positioning of the cutting tool at suitable cutting positions of interfering objects
	Interfering objects shall be able to be cut and removed without causing them to fall.	Fall prevention measures shall be implemented for the cut pieces of interfering objects.	Fall of cut pieces
	The equipment shall have a cutting tool operable in a narrow place.	<ul style="list-style-type: none"> The unit shall have a cutting tool capable of cutting estimated interfering objects. The cutting tool shall be replaceable. Interference objects shall be able to be cut into a size that fits into a planned collection container (φ390 mm × 400 mm, similar to the UC considered by the packaging and storage working group). 	<ul style="list-style-type: none"> Cutting of interfering objects into pieces of a required size or smaller Cutting tool replacement method

6. Implementation details of this project

6.2. Implementation details

2) Development of Element Technology for Retrieval Device Installation

(2) Development of Interference Object Removal during Fuel Debris Retrieval

b. Method for removing interfering objects by the fuel debris retrieval device designed for the side access method

(i) Method and procedure to remove interfering objects outside the pedestal

Based on the result of the study on work steps of the removal of interfering objects outside the pedestal and on functional requirements for each identified step, specifications of the interfering object removal device were developed and potential issues associated with the operation were identified.

Step	Functional requirements	Basic specifications of the device	Predictable issues during operation
E	Cut pieces of interfering objects shall be able to be put in a collection container.	<ul style="list-style-type: none"> · Transportation of the collection containers shall be provided. · A collection container shall be provided. It shall be designed to have dimensions and weight so that it can travel between the basement floor and above the grating through the opening of the grating (1.9 m x 0.7 m) and carry up to 50 kg of cut pieces, which is a planned amount of cut pieces in a single transportation at present · The collection container shall be designed to have a size that can contain the cut pieces of interfering objects ($\phi 390$ mm x 400 mm, similar to the UC considered by the collection and storage working group). 	<ul style="list-style-type: none"> · Method to collect cut pieces in a collection container · Method to recover from collection container fall or stuck accidents · Cut pieces fall from a collection container
	The collection container shall be able to be transported out to above the grating.		
	The collection container shall be able to be transported.		
F	The removal device shall be able to be lifted.	A method to uninstall and remove the removal device shall be provided.	<ul style="list-style-type: none"> · Method to lift the device · Accidents during the device lifting operation (fall, stuck, etc.)
G	The removal device shall be able to be carried in through the grating opening.	The device shall be designed to have dimensions so that it can get through the grating opening (1.9m x 0.7m).	<ul style="list-style-type: none"> · Device carrying-in method · Accidents during the device carrying-in operation (fall, stuck, etc.)
	The platform shall be able to be installed at the jet deflector.	The platform shall be able to be fixed to the jet deflector.	Determination of the platform fixing position

6. Implementation details of this project

6.2. Implementation details

2) Development of Element Technology for Retrieval Device Installation

(2) Development of Interference Object Removal during Fuel Debris Retrieval

b. Method for removing interfering objects by the fuel debris retrieval device designed for the side access method

(i) Method and procedure to remove interfering objects outside the pedestal

Based on the result of the study on work steps of the removal of interfering objects outside the pedestal and on functional requirements for each identified step, specifications of the interfering object removal device were developed and potential issues associated with the operation were identified.

Step	Functional requirements	Basic specifications of the device	Predictable issues during operation
H	The removal device shall be able to be carried in through the grating opening.	The device shall be designed to have dimensions so that it can get through the grating opening (1.9m x 0.7m).	<ul style="list-style-type: none"> · Device carrying-in method · Accidents during the device carrying-in operation (fall, stuck, etc.)
	<ul style="list-style-type: none"> · The operation arms shall be able to be installed on the platform. 	The operation arms shall be able to be fixed to the platform on the jet deflector.	Determination of operation arms fixing positions
I	The arms of the device shall be able to be manipulated to interfering objects.	Cutting positions of target interfering objects shall be able to be determined.	Positioning of the cutting tool at suitable cutting positions of interfering objects
J	Interfering objects shall be able to be cut and removed without causing them to fall.	Fall prevention measures shall be implemented for the cut pieces of interfering objects.	Fall of cut pieces
	The equipment shall have a cutting tool operable in a narrow place.	<ul style="list-style-type: none"> · The device shall have a cutting tool capable of cutting estimated interfering objects. · The cutting tool shall be replaceable. · Interference objects shall be able to be cut into a size that fits into a planned collection container (φ390 mm x 400 mm, similar to the UC considered by the collection and storage working group). 	<ul style="list-style-type: none"> · Cutting of interfering objects into pieces of a required size or smaller · Cutting tool replacement method

6. Implementation details of this project

6.2. Implementation details

2) Development of Element Technology for Retrieval Device Installation

(2) Development of Interference Object Removal during Fuel Debris Retrieval

b. Method for removing interfering objects by the fuel debris retrieval device designed for the side access method

(i) Method and procedure to remove interfering objects outside the pedestal

Based on the result of the study on work steps of the removal of interfering objects outside the pedestal and on functional requirements for each identified step, specifications of the interfering object removal device were developed and potential issues associated with the operation were identified.

Step	Functional requirements	Basic specifications of the device	Predictable issues during operation
K	Interfering objects shall be able to be stored in a collection container.	<ul style="list-style-type: none"> · Transportation of the collection containers shall be provided. · A collection container shall be provided. It shall be designed to have dimensions and weight so that it can travel between the basement floor and above the grating through the opening of the grating (1.9 m x 0.7 m) and carry up to 50 kg of cut pieces, which is the planned amount of cut pieces in a single transportation at present. · The collection container shall be designed to have a size that can contain the cut pieces of interfering objects ($\phi 390$ mm \times 400 mm, similar to the UC considered by the collection and storage working group). 	<ul style="list-style-type: none"> · Method to collect cut pieces in a collection container · Method to recover from collection container fall or stuck accidents · Cut pieces fall from a collection container
	The collection containers shall be able to be transported out to above the grating.		
	The collection container shall be able to be transported.		
L	The removal device shall be able to be lifted.	A method to uninstall and remove the removal device shall be provided.	<ul style="list-style-type: none"> · Method to lift the device · Accidents during the device lifting operation (fall, stuck, etc.)
Common	All devices and tools shall be able to be operated remotely.	A series of operations shall be able to be performed remotely, including the removal device assembly, arms manipulation to target interfering objects, and removal of cut pieces.	Remote operation while monitoring the condition of the device and environment in work area. A monitoring means shall be provided to enable remote operation.
	A monitoring system shall be provided to enable remote operation.	A monitoring means shall be provided to ensure clear images of points and areas needed for each operation.	Provision of the images of points and areas needed for each operation

6. Implementation details of this project

6.2. Implementation details

2) Development of Element Technology for Retrieval Device Installation

(2) Development of Interference Object Removal during Fuel Debris Retrieval

b. Method for removing interfering objects by the fuel debris retrieval device designed for the side access method

(i) Method and procedure to remove interfering objects outside the pedestal

Potential issues were identified for each step of the removal of interfering objects outside the pedestal in the previous work. In this section, it was considered whether element tests were needed to address the issues and what was to be evaluated in element tests.

Step	Predictable issues during operation	Conceptual study	Element test	Actions	Confirmation items in element tests
A	Positioning of preparation for opening	○	○	Development of a method to move and install the grating cutting device in a narrow environment	Positioning time
	Accidents during the device transportation (fall, stuck, etc.)	○	—	Identifying potential failures in addition to issues found in the above element test, developing recovery methods from the identified failures/issues through desk engineering work, and reflecting the result to the device specifications	—
B	Fall of cut pieces	○	○	Evaluation of cut piece fall prevention measures by tests	· Interfering object grabbing method · Cutting time
C	Device insertion method	○	○	Development of a method and procedure to carry in the device under the grating	· Device insertion procedures · Time needed for device insertion
	Accidents during the device insertion (fall, stuck, etc.)	○	—	Identifying potential failures in addition to issues found in the above element test, developing recovery methods from the identified failures/issues through desk engineering work, and reflecting the result to the device specifications	—
D	Positioning of the cutting tool at suitable cutting positions of interfering objects	○	○	Development of a method to position the cutting tool at target cutting positions in a narrow environment	· Positioning procedures · Positioning time
	Fall of cut pieces	○	○	Evaluation of cut piece fall prevention measures by tests	Interfering object grabbing method
	Cutting of interfering objects into pieces of a required size or smaller	○	○	Development of interfering object processing methods applicable to narrow environment	Interfering object cutting time
	Cutting tool replacement method	○	—	Desk study of required cutting tool replacement frequency based on the result of cutting tests and the reflection of the study result to the design of the device and replacement method	—

6. Implementation details of this project

6.2. Implementation details

2) Development of Element Technology for Retrieval Device Installation

(2) Development of Interference Object Removal during Fuel Debris Retrieval

b. Method for removing interfering objects by the fuel debris retrieval device designed for the side access method

(i) Method and procedure to remove interfering objects outside the pedestal

Potential issues were identified for each step of the removal of interfering objects outside the pedestal in the previous work. In this section, it was considered whether element tests were needed to address the issues and what was to be evaluated in element tests.

Step	Predictable issues during operation	Conceptual study	Element test	Concrete actions	Confirmation items in element tests
E	Method to collect cut pieces in a collection container	○	○	Measurement of time required to collect cut pieces in a collection container	· Cut piece collection time · Collection container transportation time
	Method to recover from collection container fall or stuck accidents	○	—	Identifying potential failures in addition to issues found in the above element test, developing recovery methods from the identified failures/issues through desk engineering work, and reflecting the result to the device specifications	—
	Cut pieces fall from a collection container	○	—	Desk study of measures for issues identified in the cut piece collection test as well as of cut pieces fall prevention measures and reflection of the study result to the design of the collection method	—
F	Method to lift the device	○	○	Development of a method and procedure to lift the device above the grating	· Device lifting procedures · Device lifting time
	Accidents during the device lifting operation (fall, stuck, etc.)	○	—	Identifying potential failures in addition to issues found in the above element test, developing recovery methods from the identified failures/issues through desk engineering work, and reflecting the result to the device specifications	—
G	Device carrying-in method	○	○	Development of a method and procedure to carry in the device under the grating	· Device insertion procedures · Time needed for device insertion
	Accidents during the device insertion (fall, stuck, etc.)	○	—	Identifying potential failures in addition to issues found in the above element test, developing recovery methods from the identified failures/issues through desk engineering work, and reflecting the result to the device specifications	—
	Determination of the platform fixing position	○	○	Development of a method to move and install the platform in a narrow environment	Positioning time

6. Implementation details of this project

6.2. Implementation details

2) Development of Element Technology for Retrieval Device Installation

(2) Development of Interference Object Removal during Fuel Debris Retrieval

b. Method for removing interfering objects by the fuel debris retrieval device designed for the side access method

(i) Method and procedure to remove interfering objects outside the pedestal

Potential issues were identified for each step of the removal of interfering objects outside the pedestal in the previous work. In this section, it was considered whether element tests were needed to address the issues and what was to be evaluated in element tests.

Step	Predictable issues during operation	Conceptual study	Element test	Concrete actions	Confirmation items in element tests
H	Device insertion method	○	○	Development of a method and procedure to carry in the device under the grating	· Device insertion procedures · Time needed for device insertion
	Accidents during the device insertion (fall, stuck, etc.)	○	—	Identifying potential failures in addition to issues found in the above element test, developing recovery methods from the identified failures/issues through desk engineering work, and reflecting the result to the device specifications	—
	Determination of operation arms fixing positions	○	○	Development of a method to move and install the operation arms in a narrow environment	Positioning time
I	Positioning of the cutting tool at suitable cutting positions of interfering objects	○	○	Development of a method to position the cutting tool at target cutting positions in a narrow environment	· Positioning procedures · Positioning time
J	Fall of cut pieces	○	○	Evaluation of cut piece fall prevention measures by tests	Interfering object grabbing method
	Cutting of interfering objects into pieces of a required size or smaller	○	○	Development of interfering object processing methods applicable to narrow environment	Interfering object cutting time
	Cutting tool replacement method	○	—	Desk study of required cutting tool replacement frequency based on the result of cutting tests and the reflection of the study result to the design of the device and replacement method	—

6. Implementation details of this project

6.2. Implementation details

2) Development of Element Technology for Retrieval Device Installation

(2) Development of Interference Object Removal during Fuel Debris Retrieval

b. Method for removing interfering objects by the fuel debris retrieval device designed for the side access method

(i) Method and procedure to remove interfering objects outside the pedestal

Potential issues were identified for each step of the removal of interfering objects outside the pedestal in the previous work. In this section, it was considered whether element tests were needed to address the issues and what was to be evaluated in element tests.

Step	Predictable issues during operation	Conceptual study	Element test	Concrete actions	Confirmation items in element tests
K	Method to collect cut pieces in a collection container	○	○	Measurement of time required to collect cut pieces in a collection container	· Cut piece collection time · Collection container transportation time
	Method to recover from collection container fall or stuck accidents	○	—	Identifying potential failures in addition to issues found in the above element test, developing recovery methods from the identified failures/issues through desk engineering work, and reflecting the result to the device specifications	—
	Cut pieces fall from a collection container	○	—	Desk study of measures for issues identified in the cut piece collection test as well as of cut pieces fall prevention measures and reflection of the study result to the design of the collection method	—
L	Method to lift the device	○	○	Development of a method and procedure to lift the device above the grating	· Device lifting procedures · Device lifting time
	Accidents during the device lifting operation (fall, stuck, etc.)	○	—	Identifying potential failures in addition to issues found in the above element test, developing recovery methods from the identified failures/issues through desk engineering work, and reflecting the result to the device specifications	—
Common	Remote operation while monitoring the condition of the device and environment in work area	○	○	Identification of functions required for remote operation in each work step	Identification of potential issues arising from each remote operation
	Provision of the images of points and areas needed for each operation	○	○	Determination of monitoring methods and monitoring areas suitable for each work step	· Camera installation positions · Number of cameras

6. Implementation details of this project

6.2. Implementation details

2) Development of Element Technology for Retrieval Device Installation

(2) Development of Interference Object Removal during Fuel Debris Retrieval

b. Method for removing interfering objects by the fuel debris retrieval device designed for the side access method

(i) Method and procedure to remove interfering objects outside the pedestal

Confirmation items of the element tests and criteria used to assess the feasibility of operations were studied.

No.	Test item	Relevant work steps	Test procedures	Evaluation criteria	Data and information to be obtained
1	Preparation for interfering object removal	A, B	Install the grating cutting device and construct openings.	Openings shall be able to be constructed in the grating at planned positions.	<ul style="list-style-type: none"> Positioning time Installation time Grating cutting time
2	Removal of interfering objects in access routes	C, D, F	Cut target interfering objects without causing them to fall.	The cutting tool shall be able to be positioned at planned cutting positions of interfering objects and cut them.	<ul style="list-style-type: none"> Positioning procedures Positioning time Interfering object grabbing method Interfering object cutting time Device carrying in and lifting time
3	Removal of interfering objects outside the pedestal	G, H, I, J, L	Same as above	Same as above	Same as above
4	Transfer of interfering objects	E, K	Transfer the collection container containing cut pieces of interfering objects to the transportation route.	The container shall be able to be transferred to the transportation route.	<ul style="list-style-type: none"> Cut piece collection time Collection container transportation time
5	Remote operation and monitoring test	Common	Carry out the operation of each step remotely while monitoring the operation using camera images.	All operations of above-listed tests shall be able to be monitored by cameras and carried out remotely.	<ul style="list-style-type: none"> Identifying potential issues arising from the remote operation of each step Camera installation positions Number of cameras

6. Implementation details of this project

6.2. Implementation details

2) Development of Element Technology for Retrieval Device Installation

(2) Development of Interference Object Removal during Fuel Debris Retrieval

b. Method for removing interfering objects by the fuel debris retrieval device designed for the side access method

(i) Method and procedure to remove interfering objects outside the pedestal

A mock-up to simulate densely populated structures and objects, methods to gain access to the basement floor of the pedestal, and a device required to cut and remove interfering objects and fuel debris were studied.

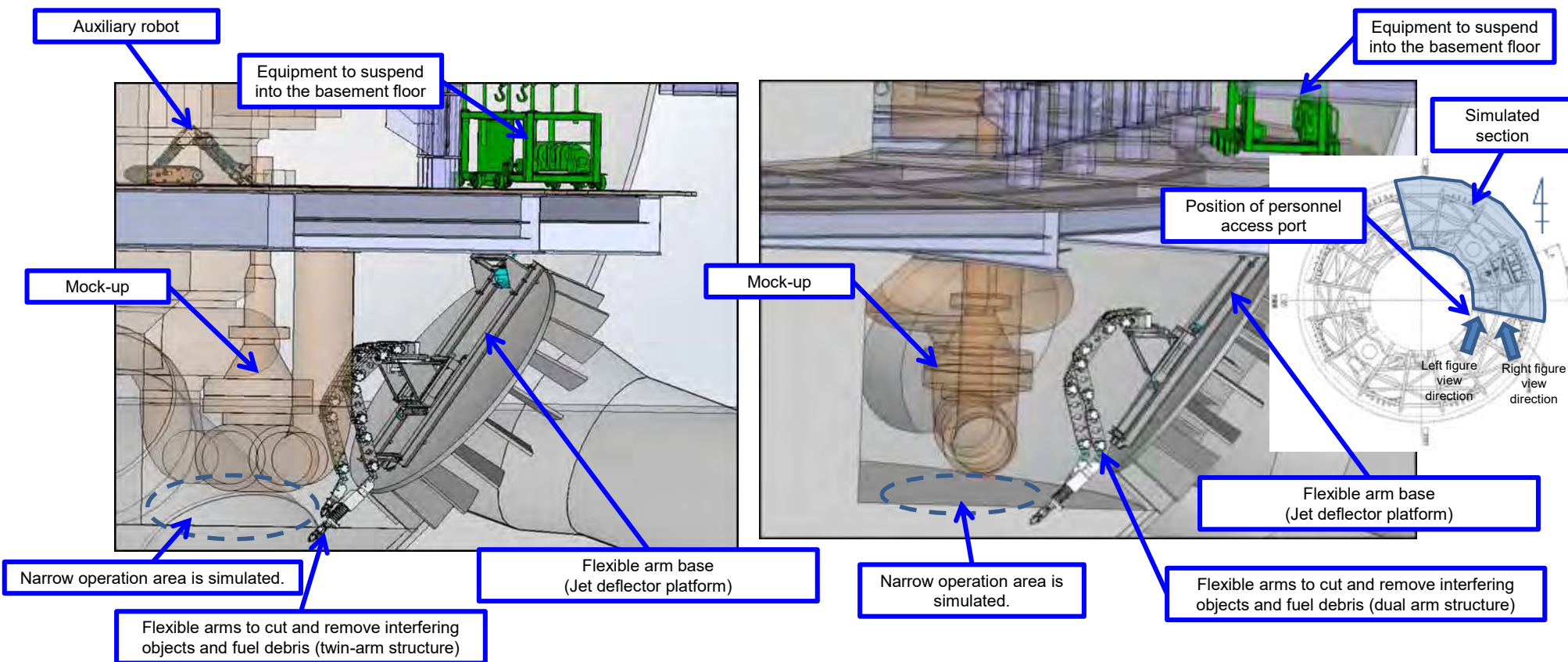

6. Implementation details of this project

6.2. Implementation details

2) Development of Element Technology for Retrieval Device Installation

(2) Development of Interference Object Removal during Fuel Debris Retrieval

b. Method for removing interfering objects by the fuel debris retrieval device designed for the side access method

(i) Method and procedure to remove interfering objects outside the pedestal

The external appearance of the simulated mock-up used for the cutting and removal test of interfering objects outside the pedestal is shown below.

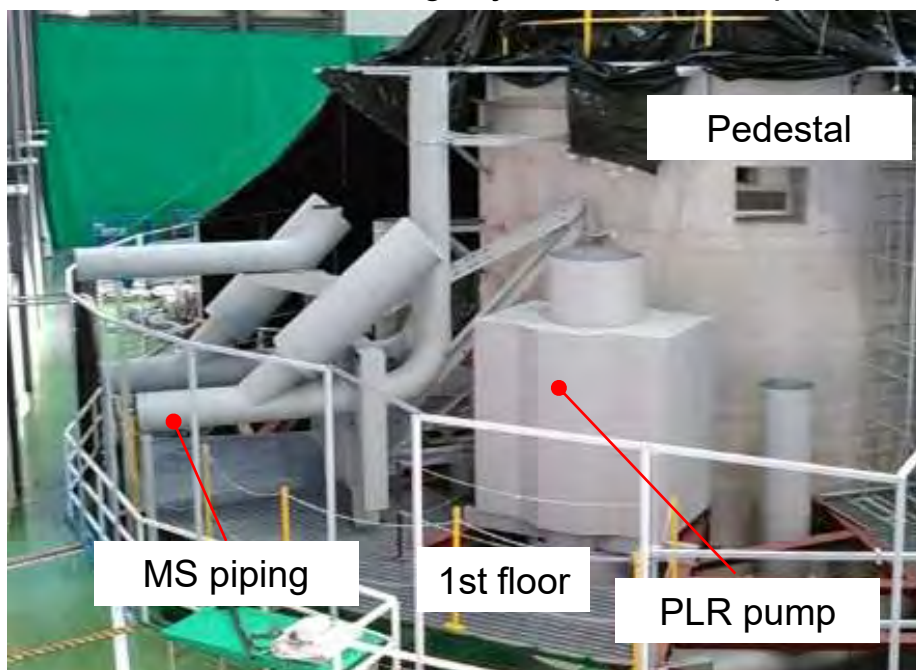

Mock-up unit on the grating

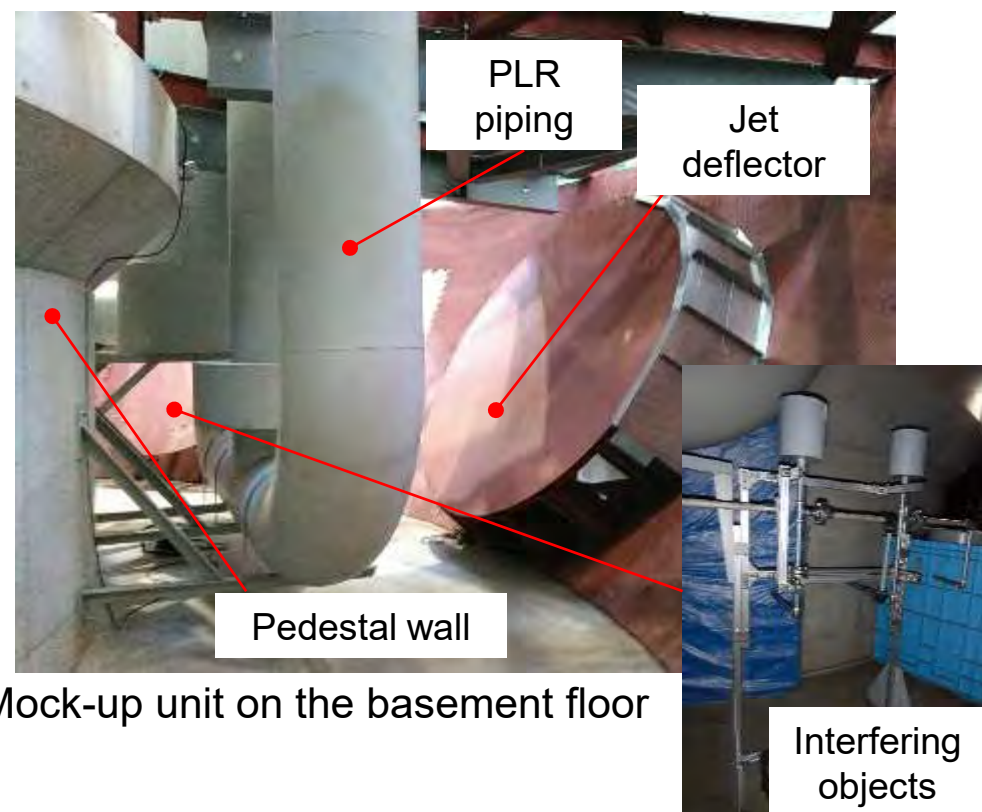

Mock-up unit on the basement floor

6. Implementation details of this project

6.2. Implementation details

2) Development of Element Technology for Retrieval Device Installation

(2) Development of Interference Object Removal during Fuel Debris Retrieval

b. Method for removing interfering objects by the fuel debris retrieval device designed for the side access method

(i) Method and procedure to remove interfering objects outside the pedestal

The external appearance of devices used for the test (transportation device and cutting device) and their main specifications are shown below.

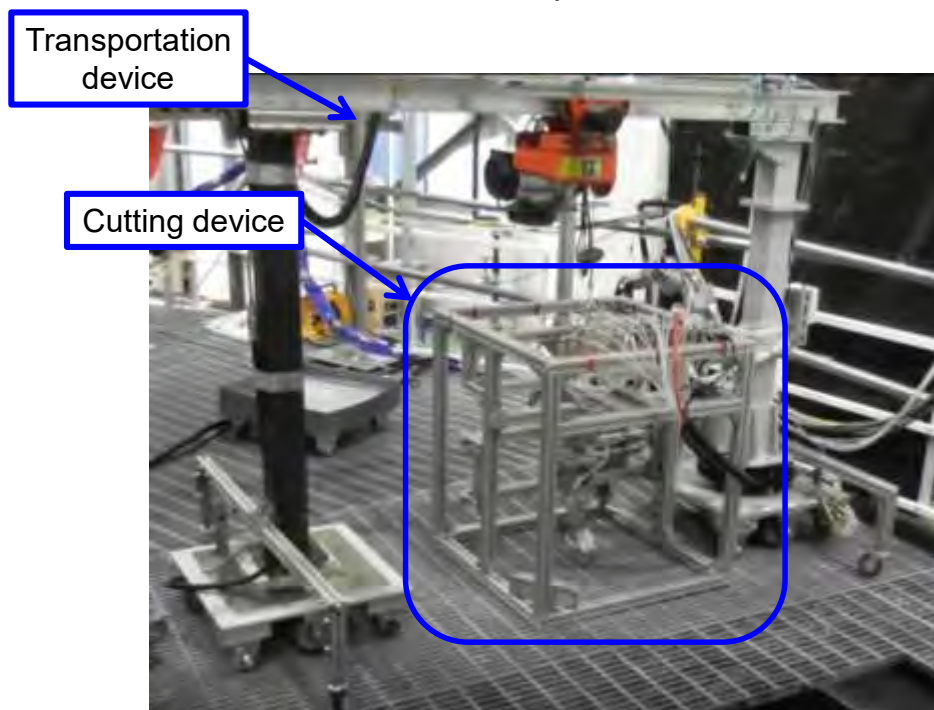

External appearance of transportation and cutting devices

Main specifications of the transportation device

Item	Specifications	Notes
Device dimensions	L800×W2360×H1354mm	
Loading capacity of the carriage	200kg	
Travel speed of the carriage	approx. 0.05 m/s	When traveling on the floor
Winch up/down speed	approx. 0.05 m/s	

Main specifications of the cutting device

Item	Specifications	Notes
Device dimensions	L750×W750×H750mm	
Device weight	80kg	
Operation range	0.5m	Maximum cutting range of the device when it is fixed
Cutting tool	Sabre saw (Reciprocating saw)	

6. Implementation details of this project

6.2. Implementation details

2) Development of Element Technology for Retrieval Device Installation

(2) Development of Interference Object Removal during Fuel Debris Retrieval

b. Method for removing interfering objects by the fuel debris retrieval device designed for the side access method

(i) Method and procedure to remove interfering objects outside the pedestal

The external appearance of the device used for the test (interfering object removal device in access routes) and its main specifications are shown below.

Main specifications of the interfering

Item	Specifications	Notes
Device dimensions	L3086×W400×H310mm	
Device weight	100kg	
Loading capacity	10 kg	

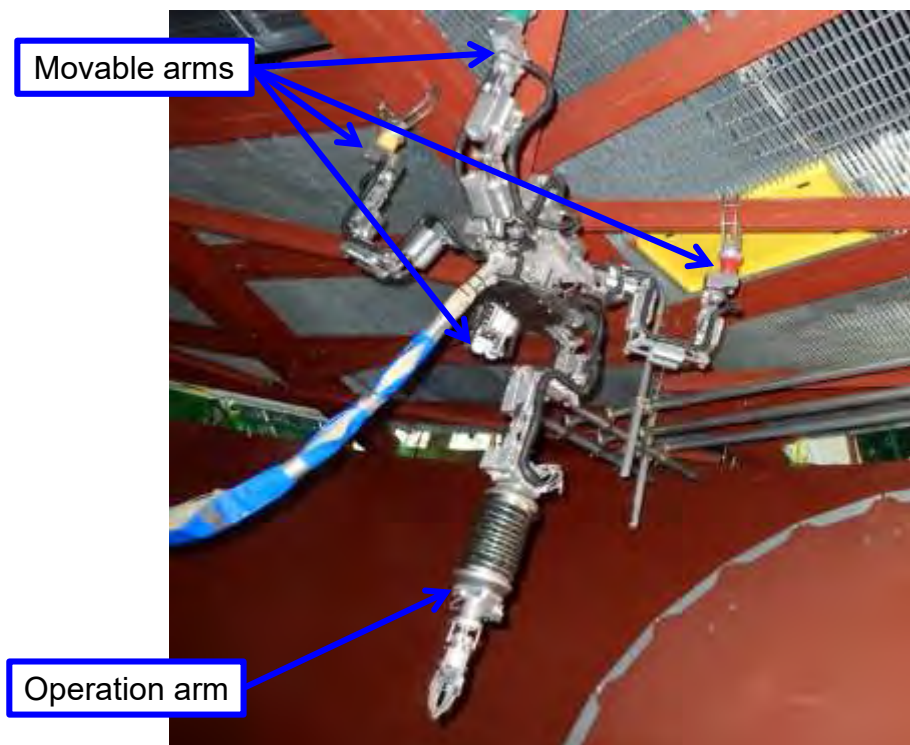

interfering object removal device in access routes

6. Implementation details of this project

6.2. Implementation details

2) Development of Element Technology for Retrieval Device Installation

(2) Development of Interference Object Removal during Fuel Debris Retrieval

b. Method for removing interfering objects by the fuel debris retrieval device designed for the side access method

(i) Method and procedure to remove interfering objects outside the pedestal

The external appearance of the device used for the test (interfering object removal device outside the pedestal) and its main specifications are shown below.

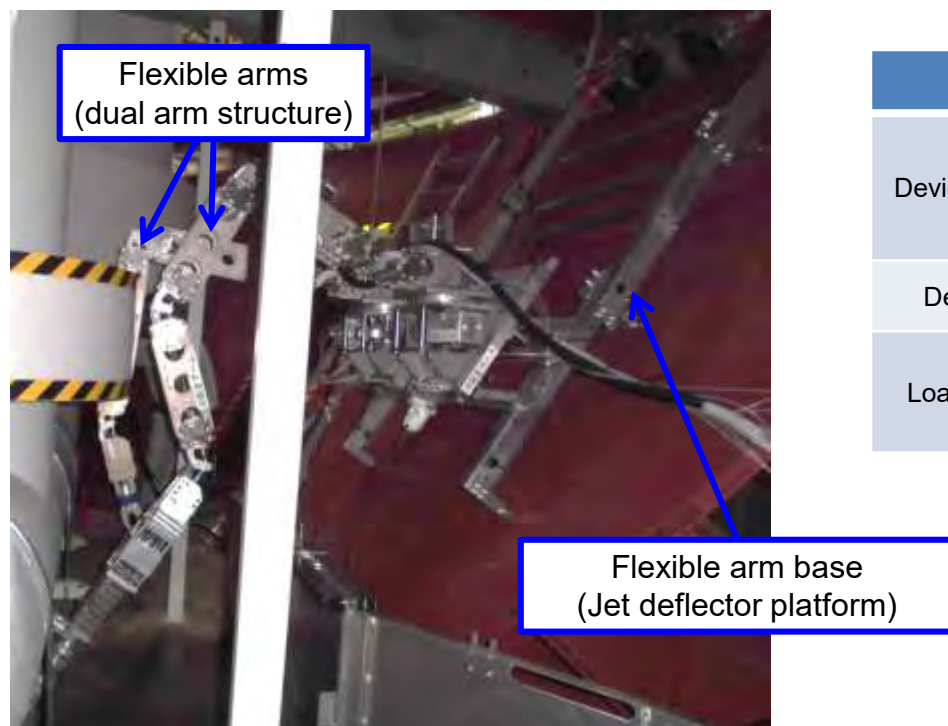

Interfering object removal device outside the pedestal

Main specifications of the interfering

Item	Specifications	Notes
Device dimensions	L2200 × W1500 × H400 mm (base section) Arm length: 2,300 mm and 2,800 mm respectively	
Device weight	400kg	
Loading capacity	10 kg for 2,800 mm arm 20 kg for 2,300 mm arm	

6. Implementation details of this project

6.2. Implementation details

2) Development of Element Technology for Retrieval Device Installation

(2) Development of Interference Object Removal during Fuel Debris Retrieval

b. Method for removing interfering objects by the fuel debris retrieval device designed for the side access method

(i) Method and procedure to remove interfering objects outside the pedestal

Operation time was measured during the element tests and used to analyze throughput. Photos of the operation of devices in each work step are also shown.

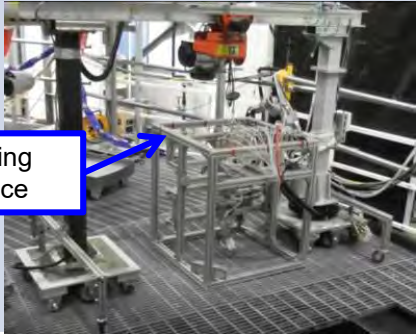
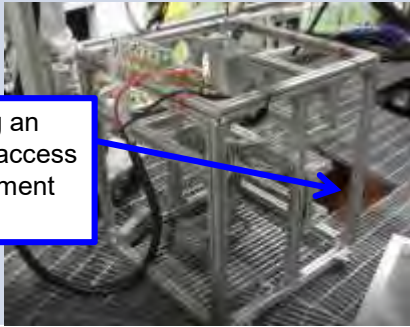
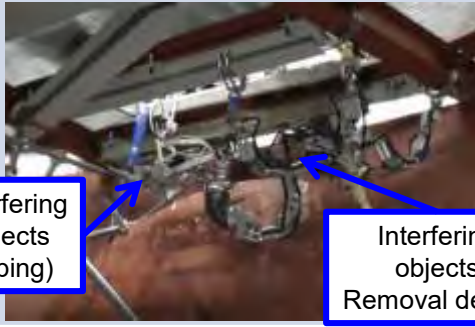
Work step	A. Preparing for making open space to access the basement floor (Carrying in the grating cutting device)	B. Creating an opening to access the basement floor (Cutting the grating)	C. Installing the device to remove interfering objects in access routes to the basement floor
Illustrations/ photos of operation			
Operation time	For cutting device positioning: approx. 2 hours/location (Started from near opening construction locations)	For grating cutting: approx. 16 hours/location (Approx. 2 h for each 500mm square opening)	For device installation and setup: approx. 0.5 hour/location (until being mounted on the beam under the grating)

6. Implementation details of this project

6.2. Implementation details



2) Development of Element Technology for Retrieval Device Installation

(2) Development of Interference Object Removal during Fuel Debris Retrieval

b. Method for removing interfering objects by the fuel debris retrieval device designed for the side access method

(i) Method and procedure to remove interfering objects outside the pedestal

Operation time was measured during the element tests and used to analyze throughput. Photos of the operation of devices in each work step are also shown.

Work step	D. Grabbing, cutting, and collecting interfering objects	E. Transferring collected interfering objects to the transportation route	F. Uninstalling the device to cut and remove interfering objects in access routes to the basement floor
Illustrations/ photos of operation			
Operation time	<ul style="list-style-type: none"> · For cutting tool positioning: approx. 0.3 hour/object (Time of cutting tool moving to the cutting position and grabbing an interfering object) · For interfering object cutting: approx. 1 min/object (SS pipe with $\phi 48.6\text{mm}$ diameter and 1.6mm thickness) · For cut piece collection: approx. 0.1 hour/object (putting the cut piece in a collection container) 	<ul style="list-style-type: none"> · For the collection container transportation: approx. 0.3 hour/trip (from lifting the container to loading it on a transfer carriage) 	<p>For the device lifting: approx. 0.3 hour/location</p>

6. Implementation details of this project

6.2. Implementation details



2) Development of Element Technology for Retrieval Device Installation

(2) Development of Interference Object Removal during Fuel Debris Retrieval

b. Method for removing interfering objects by the fuel debris retrieval device designed for the side access method

(i) Method and procedure to remove interfering objects outside the pedestal

Operation time was measured during the element tests and used to analyze throughput. Photos of the operation of devices in each work step are also shown.

Work step	G. Preparation of the interfering object removal device outside the pedestal	H. Installing operation arms for interfering object removal	I. Manipulating the arms to target interfering objects
Illustrations/ photos of operation			
Operation time	For base structure installation and setup: approx. 2 hours/location (Starting after locating the structure at the creating an opening)	For arms installation and setup: approx. 6 hours/location (Starting after locating the arms at the creating an opening)	For cutting tool positioning: approx. 0.2 hours/object (Time needed to reach and grab an interfering object located at the farthest reachable place)

6. Implementation details of this project

6.2. Implementation details



2) Development of Element Technology for Retrieval Device Installation

(2) Development of Interference Object Removal during Fuel Debris Retrieval

b. Method for removing interfering objects by the fuel debris retrieval device designed for the side access method

(i) Method and procedure to remove interfering objects outside the pedestal

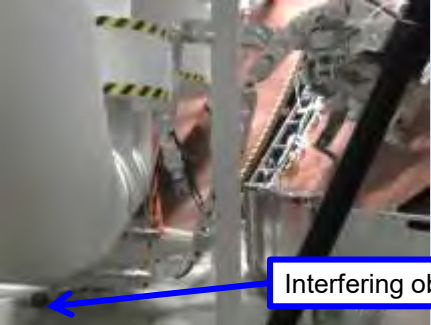
Operation time was measured during the element tests and used to analyze throughput. Photos of the operation of devices in each work step are also shown.

Work step	J. Grabbing and cutting interfering objects	K. Transferring collected interfering objects to the transportation route	L. Uninstalling the device
Illustrations/ photos of operation			
Operation time	<ul style="list-style-type: none"> · For interfering object cutting: approx. 1.5 min/object (SS pipe with $\phi 27.2$mm diameter and 3.9mm thickness) · For cut piece collection: approx. 0.1 hour/object (storing the cut piece in a collection container) 	<ul style="list-style-type: none"> · For the collection container transportation: approx. 0.3 hour/trip (from lifting the container to loading it on a transfer carriage) 	<ul style="list-style-type: none"> · For the device lifting: approx. 8 hours/location

6. Implementation details of this project

6.2. Implementation details

2) Development of Element Technology for Retrieval Device Installation

(2) Development of Interference Object Removal during Fuel Debris Retrieval

b. Method for removing interfering objects by the fuel debris retrieval device designed for the side access method

(i) Method and procedure to remove interfering objects outside the pedestal

Operation time measured in the element tests was summarized in the table below by the type of processes.

No.	Test item	Test procedure	Operation time per cycle	Total operation time	Notes
1	Preparation for interfering object removal (Steps A to C, G and H)	After locating the grating cutting device, construct openings in the grating by it, and install two interfering object removal devices in access routes and those outside the pedestal.	Operation time per grating opening location: approx. 27 hours	This process is needed in two locations Total operation time: approx. 54 hours	Based on the assumption that fuel debris spreads in an angle of 120° outside the pedestal
2	Removal of interfering objects in access routes (Step D)	Cut interfering objects in access routes and collect them in a collection container.	For one cut-and-collect cycle: approx. 3.4 hours	The number of cycles needed is four (4) Total operation time: approx. 13.6 hours	Based on the assumption that a 1m-long cylindrical structure is cut into five 0.2m-long pieces
3	Removal of interfering objects outside the pedestal (Steps I and J)	Cut target interfering objects and collect them in a collection container.	For one cut-and-collect cycle: approx. 0.6 hour	The number of cycles needed is four (4) Total operation time: approx. 2.4 hours	
4	Transfer of interfering objects (Steps E and K)	Transfer a collection container containing cut pieces of interfering objects to the transportation route.	One cycle of collection container transportation: approx. 0.3 hours	The number of cycles needed is five (5). Total operation time: approx. 1.5 hours (The above total operation time is needed for each group of interfering objects in access routes and of those outside the pedestal.)	
Others	Uninstallation of devices (Steps F and L)	Uninstall the interfering object removal devices in access routes and outside the pedestal and move them on the grating.	Operation time per grating opening: approx. 9 hours	This process is needed in two locations Total operation time: 18 hours	

6. Implementation details of this project

6.2. Implementation details

2) Development of Element Technology for Retrieval Device Installation

(2) Development of Interference Object Removal during Fuel Debris Retrieval

b. Method to remove interfering objects by the fuel debris retrieval device designed for the side access method

(i) Method and procedure to remove interfering objects outside the pedestal

Results of the element tests and main issues identified in each process

No.	Test item	Test results	Main issues	Action policy*
1	Preparation for interfering object removal	The grating cutting device was installed and openings to the basement floor were constructed.	Shortening of time to locate the grating cutting device at desired positions remotely	Development of a manipulation support function applicable to the cutting device
			Shortening of grating cutting time	Redesign of cutting procedure and method and cutting speed increase
			Transportation of the cutting device from the entrance of the equipment hatch to the installation location	Detailed design of devices and equipment carrying in/ out method (*)
			Monitoring of remote cutting operation	Detailed design of a method to install monitoring equipment remotely (*)
2	Removal of interfering objects in access routes	Special devices designed and built for removal work were installed from above the grating, and simulated structures laid out in a narrow place were cut by them.	Shortening of the removal devices installation time	Streamlining of installation method
			Shortening of time to locate cutting tools at desired cutting positions	Development of a cutting tool locating supporting function
			Expansion of interfering object cutting devices covering range	Detailed design of device transportation routes
			Method to monitor operation in areas distant from the openings	Development of a method to provide an external point of view in combination with images from installed cameras
3	Removal of interfering objects outside the pedestal		Shortening of the removal device's installation and assembling time	Streamlining of installation and assembling method
			Remote operation monitoring	Detailed design of a method to install monitoring equipment remotely (*)
			Shortening of the removal device's uninstallation time	Streamlining of uninstallation method
4	Transfer of interfering objects	Cut pieces of interfering objects were put in collection containers and transported out to the top of the grating.	Interface mechanism between the collection container and the transport container and remote connection/disconnection method	Development of the interface mechanism and a method easy to connect and disconnect remotely
			Shortening of time to put cut pieces in collection containers	Shortening of time to locate cutting tools and collection containers at desired positions
			Shortening of collection container carrying in/out time	Streamlining of collection container carrying in/out method (*)
5	Remote operation and monitoring test	The layout of cameras required to realize remote operation was examined.	Remote operation monitoring	Detailed design of a method to install monitoring equipment remotely (*)
			Expansion of areas covered by remote operation	Introduction of remote operation for the installation and construction of operation devices and peripheral equipment (*)

Actions with an asterisk () will be set out in the following fiscal year onward. Others will be worked on through future engineering activities.

6. Implementation details of this project

6.2. Implementation details

2) Development of Element Technology for Retrieval Device Installation

(2) Development of Interference Object Removal during Fuel Debris Retrieval

b. Method to remove interfering objects by the fuel debris retrieval device designed for the side access method

(ii) Method and procedure used to enlarge existing openings in the PVC wall for enabling the entry of arm-type devices into the PCV

- Development purpose: Establishment of PCV opening method and procedure
- Basic requirements:
 - An opening large enough for the installation of work cells shall be able to be constructed.
 - The method shall not deteriorate the soundness of the PCV.
 - The diffusion of radioactive materials via cutting chips and wastewater shall be minimized.
 - Worker exposure associated with the operation shall be minimized.
- Approaches to the development: Combining unit tests and combination tests according to the purposes

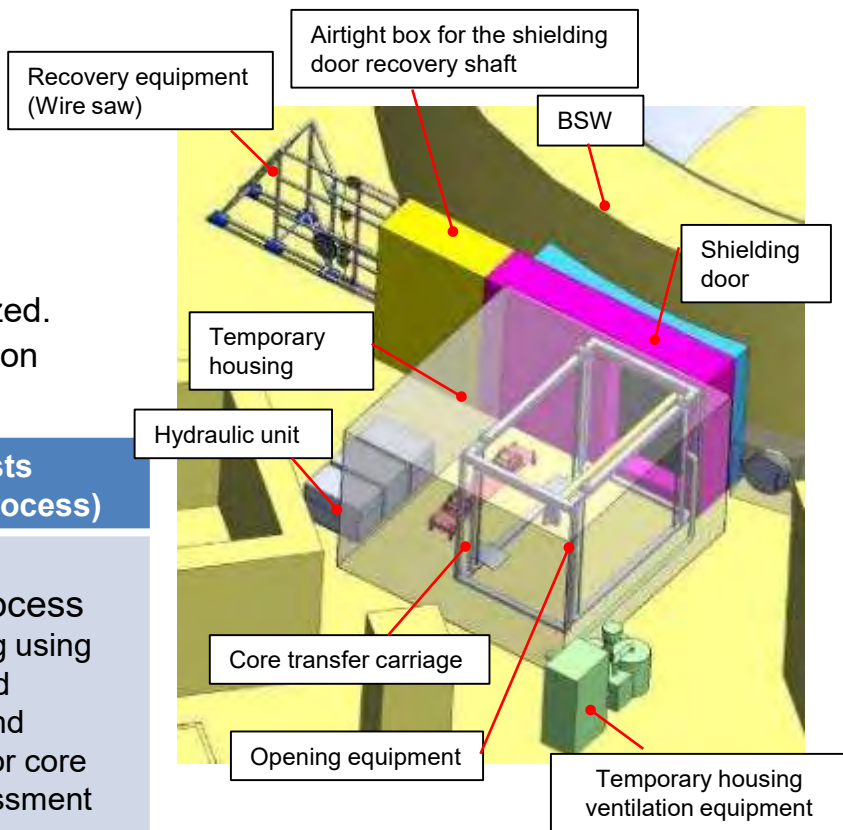

Unit element tests (Acquisition of basic data)	Combination element tests (Confirmation of operation process)
<p>Confirmation of the principles</p> <ul style="list-style-type: none"> • A through-hole shall be able to be constructed in 1.8m-thick concrete wall. (Aged deterioration of rebar and strength, variation of engage angle). • Evaluation of cutting parameters Operation time, necessary water feed rate, inclination of opening for collection operation • Method to release a stuck core sleeve 	<p>Confirmation of operation process</p> <ul style="list-style-type: none"> • Construction of a large opening using an overlapping opening method • Evaluation of workers layout and operation time measurement for core sleeve change Exposure assessment based on measured data • Evaluation of workability in the housing

6.2. Implementation details

2) Development of Element Technology for Retrieval Device Installation

(2) Development of Interference Object Removal during Fuel Debris Retrieval

b. Method to remove interfering objects by the fuel debris retrieval device designed for the side access method(ii) Method and procedure used to enlarge existing openings in the PVC wall for enabling the entry of arm-type devices into the PCV

- Confirmation items and intended results of the tests
 - Criteria to pass the unit test: A through-hole can be constructed in a BSW mock-up.
 - Criteria to pass the combination test: The feasibility of interfering object removal method and procedure has been demonstrated through tests with full-scale interfering object simulants.

Legend:

◎: Intended result was obtained

Phase	Purposes of tests (Test items)	Unit test	Combination test	Notes
1) BSW opening operation				
Core sleeve carrying in/out	To measure operation time for core sleeves carrying in/out and attaching/detaching them to/from the opening equipment.	—	◎	
BSW opening	To make sure that through-holes (single hole and overlapping-holes) can be constructed in a BSW mock-up (1.8 m thick, with rebar and formwork)	◎	◎	
	Evaluate the amount of dust generated to assess impact on work environment.	◎ Visual observation	◎ Quantitative assessment	
	To make sure that a core bit can be accurately located at planned positions in a full-scale BSW mock-up and holes (only along the outline) can be constructed	—	◎	
	To make sure that the condition of cooling water can be monitored remotely (by cameras and/or microphones)	—	◎	
2) Stuck core sleeve release operation				
Core sleeve cutting	To make sure that a core sleeve can be cut by a wire saw	◎	—	
Attachment of large-diameter core sleeve	To measure operation time to attach a large-diameter core sleeve to the opening equipment.	—	◎	
Large-diameter coring	To make sure that a regular-diameter core sleeve can be released when it is stuck during coring.	◎	—	

6. Implementation details of this project

6.2. Implementation details

2) Development of Element Technology for Retrieval Device Installation

(2) Development of Interference Object Removal during Fuel Debris Retrieval

b. Method to remove interfering objects by the fuel debris retrieval device designed for the side access method

(ii) Method and procedure used to enlarge existing openings in the PVC wall for enabling the entry of arm-type devices into the PCV

- Test procedures

- Perform core boring in the wall of BSW and PCV full-scale mock-ups by remote control. Evaluate the dimensions of the opening and the deformation and burrs of the BSW formwork.
- Obtain data required to design the following equipment used in the BSW opening operation at the actual site: cooling water supply equipment, waste cooling water collection equipment, waste cooling water-borne cutting dust collection equipment, and airborne cutting dust collection equipment. Such data includes the amount of cooling water and cutting dust generated, water flow and dust diffusion path, and dust size distribution.
- Verify the feasibility of stuck core sleeve release operation.
- Measure operation time for core bit change

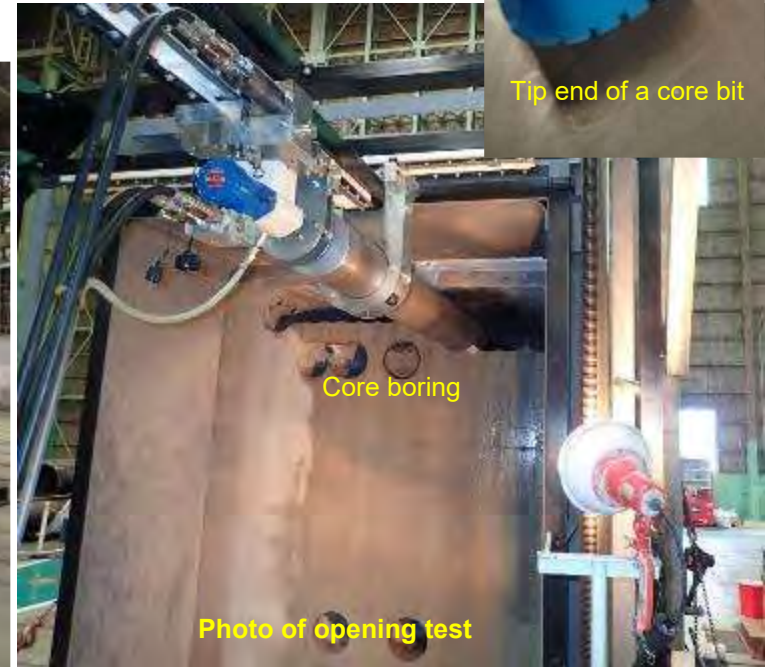
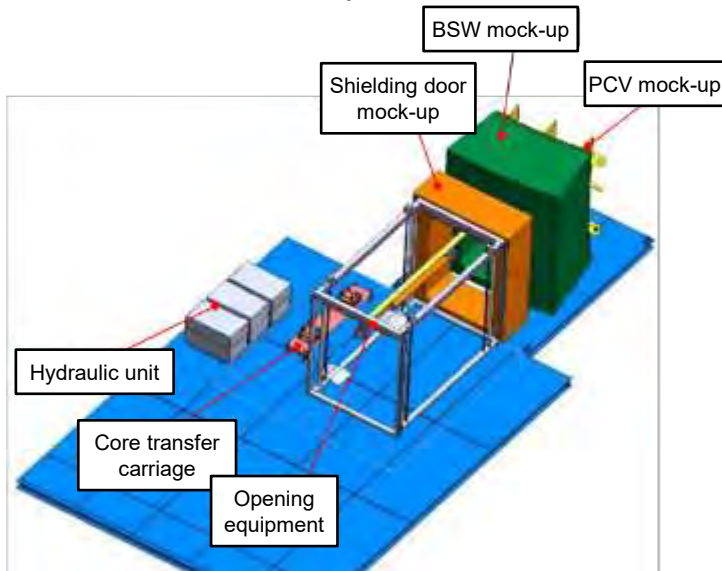

6. Implementation details of this project

6.2. Implementation details

2) Development of Element Technology for Retrieval Device Installation

(2) Development of Interference Object Removal during Fuel Debris Retrieval

b. Method to remove interfering objects by the fuel debris retrieval device designed for the side access method

(ii) Method and procedure used to enlarge existing openings in the PVC wall for enabling the entry of arm-type devices into the PCV

- Test results
- Total 75 holes (diameter of 200 mm, pitch of 100 mm) were bored.
- The dimensions of the constructed opening were the following against the targets of 1,685 mm for short side and 2,300 mm for long side: 1,682 to 1,695 mm for short side and 2,303 to 2,308 mm for long side on the near side (outer wall of BSW); and 1,681 to 1,699 mm for short side and 2,297 to 2,312.5 mm for long side on the far side (PCV-side wall). Dimensional errors were suppressed within approx. 0.2% though they were slightly greater on the far side.
- Operation time varied from 1 hour 13 minutes to 2 hours 56 minutes with an average of 1 hour 55 minutes per hole. Operation time tended to be longer when opening dense rebar areas.

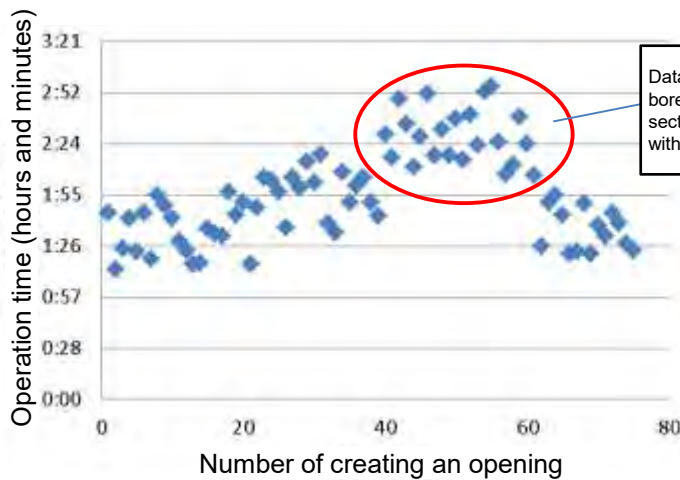

Operation time per one opening

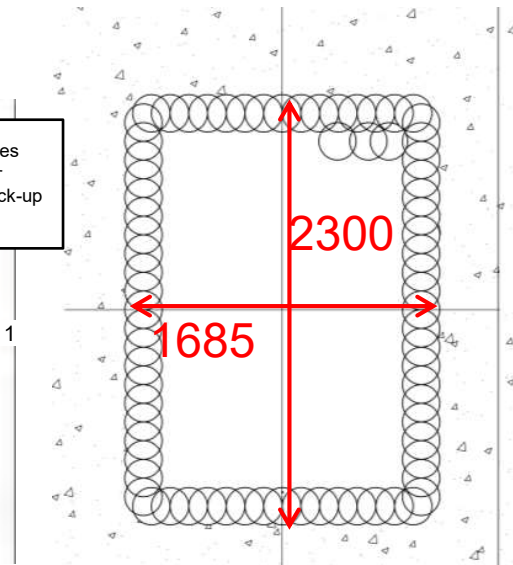

Plan of opening positions



Opening part of BSW mock-up

6. Implementation details of this project

6.2. Implementation details

2) Development of Element Technology for Retrieval Device Installation





(2) Development of Interference Object Removal during Fuel Debris Retrieval

b. Method to remove interfering objects by the fuel debris retrieval device designed for the side access method

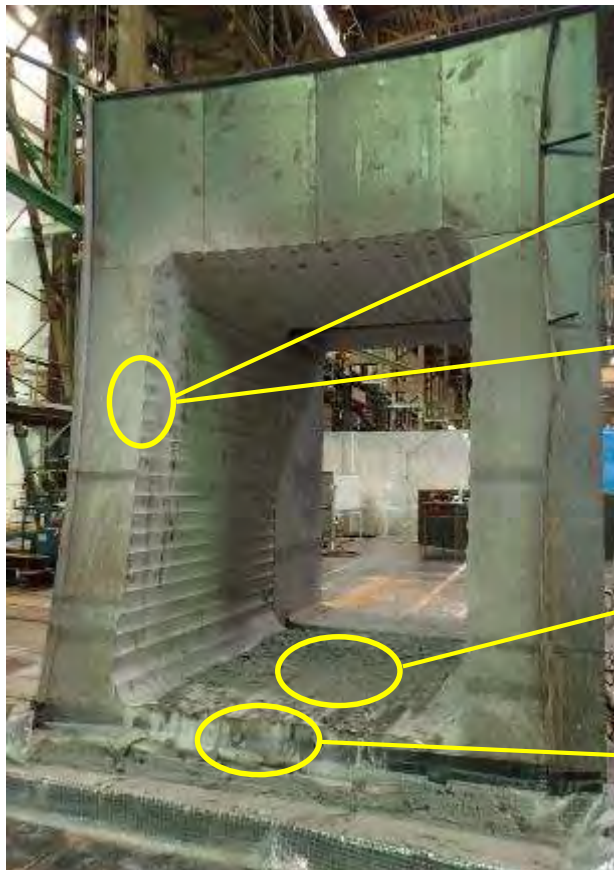
(ii) Method and procedure used to enlarge existing openings in the PVC wall for enabling the entry of arm-type devices into the PCV

● Identified issues



Identified issues	Action plan toward designing actual equipment
	Burr on the BSW formwork (approx. 1 to 5 mm, max. 10 mm) Burr must be removed before installing inflate seals. A burr removal test was performed in this combination test.
	The BSW formwork was peeled from concrete and bent. (Max. gap between the formwork and concrete was 7 mm.) Sealant will be applied to peeled part when inflate seals are installed. Sealant application method was tested in this combination test.
	Concrete dust (sludge) deposited on the floor of the opening construction site. The dust must be washed off by water, or dispersion prevention measures need to be taken such as preparing curing iron plates since the dust solidifies when dried.
	Cut pieces of the BSW formwork and concrete dust (sludge) fell between the formwork and the PCV. A method to check the condition of the inflate seal contacting surfaces visually was tested in this combination test.

6. Implementation details of this project

6.2. Implementation details

2) Development of Element Technology for Retrieval Device Installation

(2) Development of Interference Object Removal during Fuel Debris Retrieval

b. Method to remove interfering objects by the fuel debris retrieval device designed for the side access method

(ii) Method and procedure used to enlarge existing openings in the PVC wall for enabling the entry of arm-type devices into the PCV

- Cooling water supply (4 L/min, total 460 L/hole)
- 4L of concrete dust (sludge) is generated per hole
- 409.4 L (88%) flows to the equipment side (near side) while 54.6 L (12%) falls in the gap between the BSW and the PCV.
- Total 183 holes are required. **Total 109.8 L of sludge falls in the gap.**

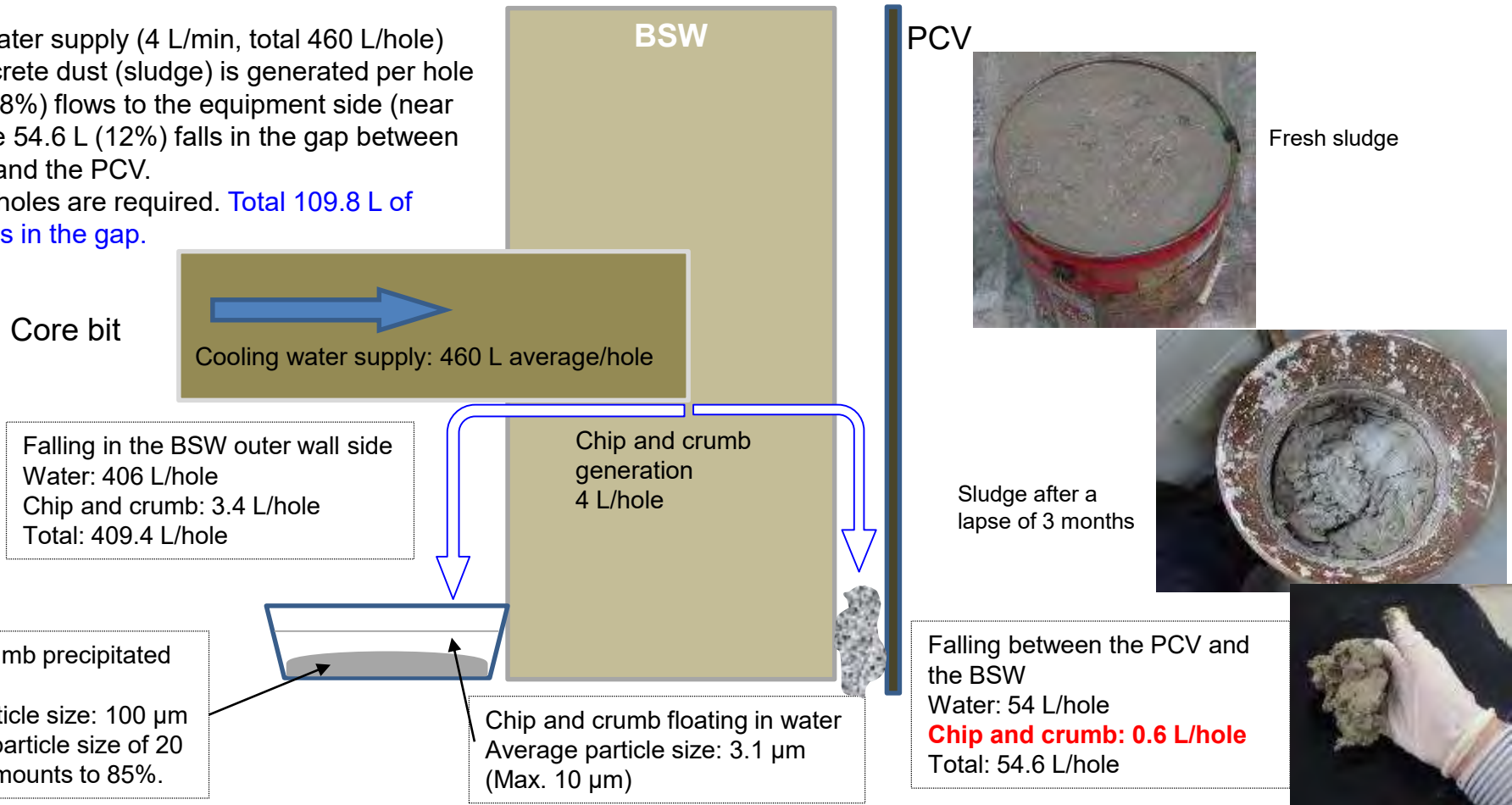

6. Implementation details of this project

6.2. Implementation details

2) Development of Element Technology for Retrieval Device Installation

(2) Development of Interference Object Removal during Fuel Debris Retrieval

b. Method to remove interfering objects by the fuel debris retrieval device designed for the side access method

(ii) Method and procedure used to enlarge existing openings in the PVC wall for enabling the entry of arm-type devices into the PCV

Evaluation of dust (Contamination of investigation points)

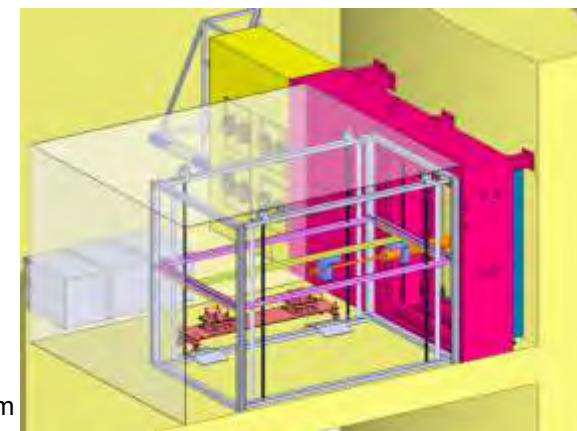
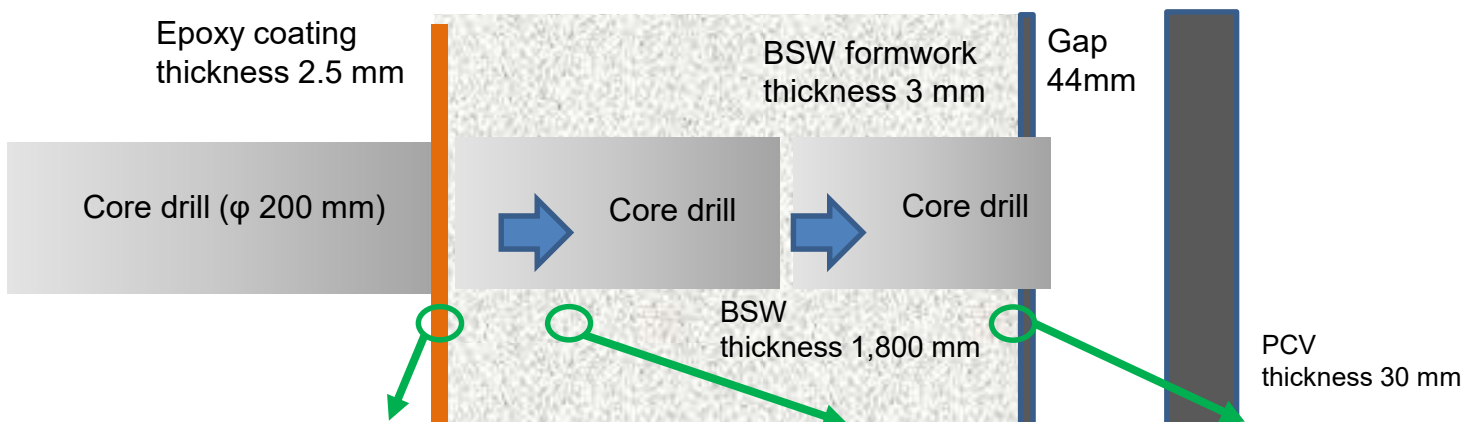

BSW surface coating Government R&D project “Development of Remote Decontamination Technology in the Reactor Building” Sampling investigations were performed in FY2012. (Actual measurement)	Concrete surface and inside (Same as the left, actual measurement)	BSW formwork surface “Development of technology required for PCV inside investigation” Evaluated in FY2017 (estimate for PCV inner surface)
<ul style="list-style-type: none"> Contaminated up to a depth of 1 mm (thickness of 2.5 mm) The penetration of contamination occurred at a flaw in the epoxy coating, no penetration in the main coating layer Max. 60 kBq/cm² Dominant contaminants are Cs134 and Cs137. 	Contamination was not detected in actual measurements.	The following contaminants were assumed as the origin of surface contamination: Cs: 8.5×10 ¹⁰ Bq/m ² Pu: 2.07×10 ³ Bq/mm ²

- The contamination of the BSW was thought to be limited to that of the coating surface (of the outer wall) and of the BSW formwork by the adhesion of contaminants, and not to have occurred in its entire part. Therefore, an investigation was conducted focusing on the dispersion of contaminants in those areas and the vicinity of them.
- For reference in the future, the dispersion of contaminants in the center area was also investigated.

6. Implementation details of this project

No.270

6.2. Implementation details

2) Development of Element Technology for Retrieval Device Installation

(2) Development of Interference Object Removal during Fuel Debris Retrieval

b. Method to remove interfering objects by the fuel debris retrieval device designed for the side access method

(ii) Method and procedure used to enlarge existing openings in the PVC wall for enabling the entry of arm-type devices into the PCV

Plan to collect and evaluate dust generated in BSW opening tests

- The evaluation of dust generation shall be conducted in the following three locations taking into consideration the anticipated contamination of the actual BSW at the site: **BSW surface and its vicinity (for the initial instance of a core bit bite), formwork and its vicinity (during opening), and the intermediate part of the BSW (for reference)**. Dust collection shall be conducted in areas close to the aforementioned target locations as much as possible to evaluate the amount of dispersion near surface.
- The same epoxy coating as that used for the R/B wall shall be applied to the surface of the BSW to simulate the contamination of the actual BSW at the site, which is limited to the coating.
- Dust collection shall be conducted for the following two operations: **single opening and continuous opening operations**.
- Dust collection shall be conducted from the following two directions: from the outer wall surface of the BSW (from **the opening start point**), and from the BSW formwork (from **the opening end point**).
- Dust shall be sucked through a dust collection hood, and **its total amount (weight) and the particle size distribution of sampled dust shall be measured**. The ratio of the collected dust weight to the weight scraped off by the core bit shall be calculated as a dispersion factor. The calculation method is as follows:

Dispersion factor = (Actual measurement of collected dust weight) / (Weight scraped off)

Weight scraped off = {Area of the cross-section scraped off (actual measurement)} x {Travel distance of the core bit (change in the coordinate value of the core bit)}

6. Implementation details of this project

6.2. Implementation details

2) Development of Element Technology for Retrieval Device Installation

(2) Development of Interference Object Removal during Fuel Debris Retrieval

b. Method to remove interfering objects by the fuel debris retrieval device designed for the side access method

(ii) Method and procedure used to enlarge existing openings in the PVC wall for enabling the entry of arm-type devices into the PCV

- Airborne dust generated by the BSW opening operation was collected, and its total weight, dispersion factor, and particle size distribution were measured.
- The dispersion factor ranged approximately from 0.002% to 0.028%

		Weight of collected dust (mg)	Dispersion factor (%)
Single opening	Surface part	47.7	0.028%
	Intermediate part	3.0	0.0028%
	Rear part (PCV side)	0.2	0.00003%
Continuous opening	Surface part	6.1	0.0072%
	Intermediate part	13.8	0.0019%
	Rear part (PCV side)	39.2	0.013%

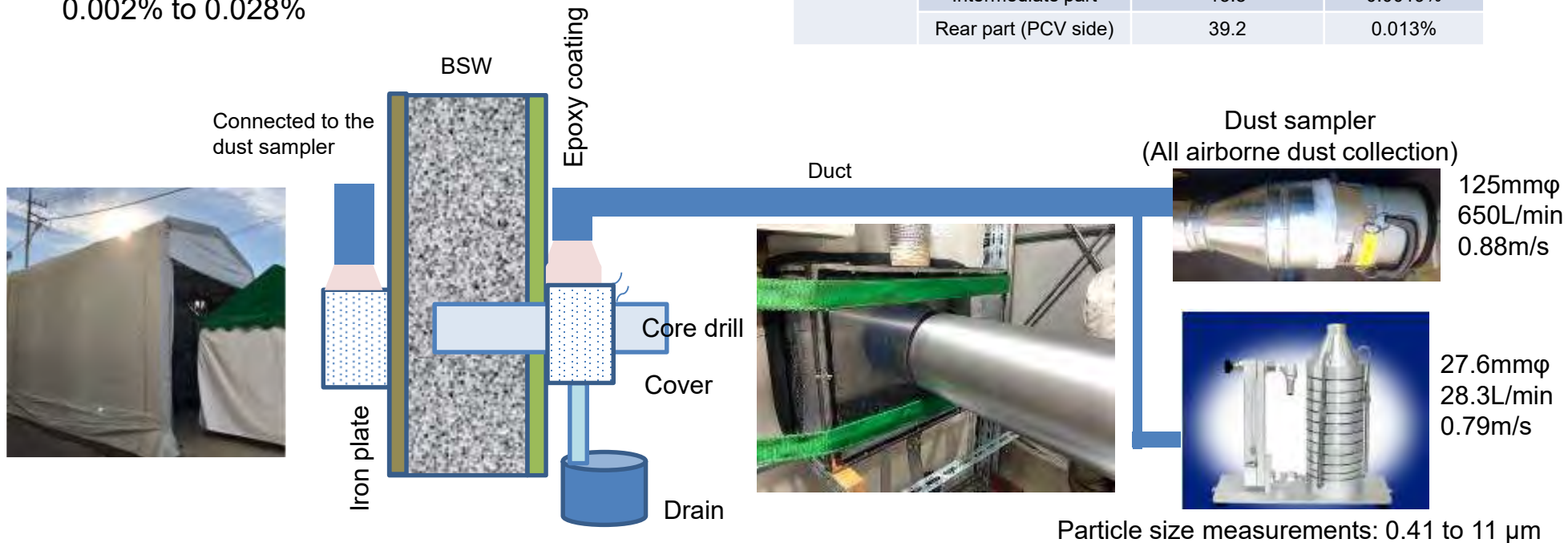

Particle size measurements: 0.41 to 11 μm

6. Implementation details of this project

No.272

6.2. Implementation details

2) Development of Element Technology for Retrieval Device Installation

(2) Development of Interference Object Removal during Fuel Debris Retrieval

b. Method to remove interfering objects by the fuel debris retrieval device designed for the side access method

(ii) Method and procedure used to enlarge existing openings in the PVC wall for enabling the entry of arm-type devices into the PCV

Results and photos of dust sampling tests by a dust sampler

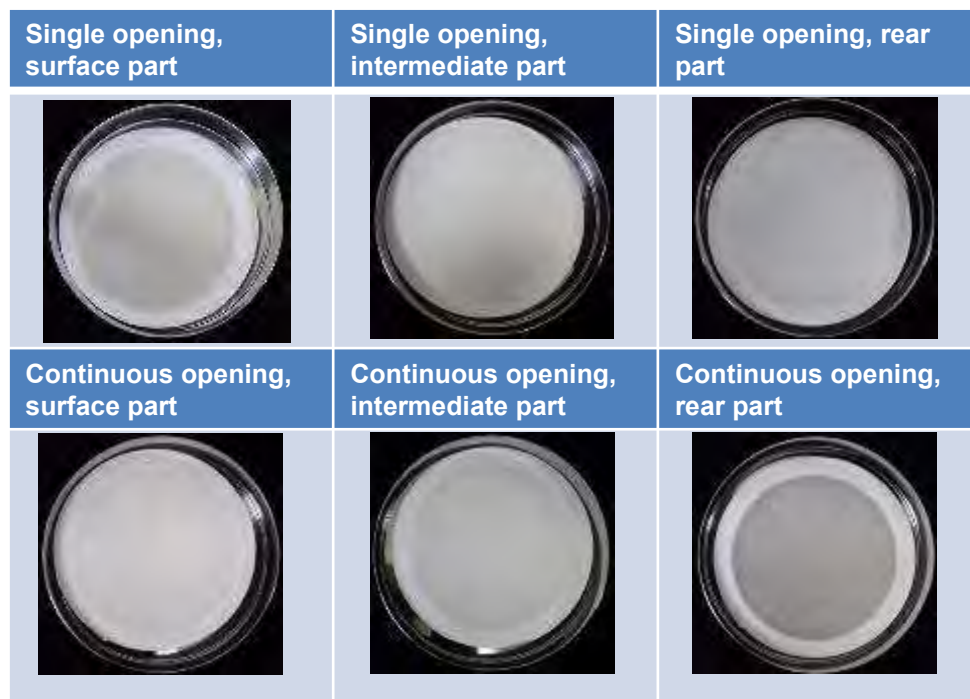

Results of particle size classification

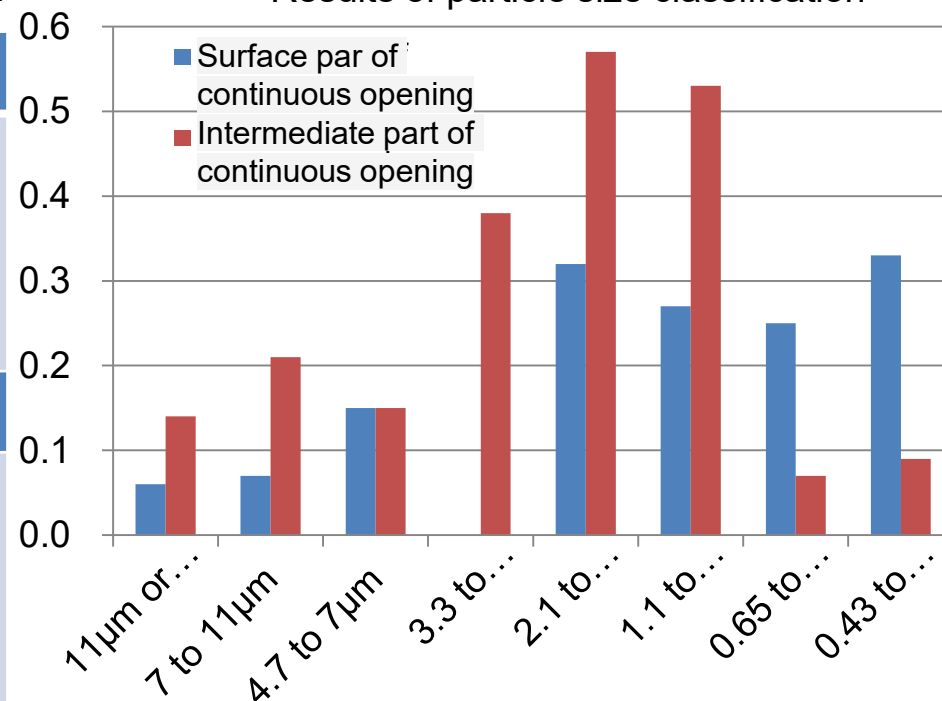

6. Implementation details of this project

6.2. Implementation details

2) Development of Element Technology for Retrieval Device Installation

(2) Development of Interference Object Removal during Fuel Debris Retrieval

b. Method to remove interfering objects by the fuel debris retrieval device designed for the side access method

(ii) Method and procedure used to enlarge existing openings in the PVC wall for enabling the entry of arm-type devices into the PCV

- Workers' movement was tracked during core sleeve installation/uninstallation operation
- Operation time for changing core sleeves (uninstalling a used sleeve and installing a new sleeve) after the completion of a through-hole was measured. Part of the actual operation process was simulated, and core sleeve installation/uninstallation operation by workers wearing protection equipment such as Tyvek clothing, full-face mask, and gloves was also tested.
- It was determined adequate to perform this process by three workers as a group.
- Operation time ranged from 10 to 17 minutes for single change operation regardless of worker protection equipment being worn or not. A reason of no significant difference in operation time between with and without protection equipment may be attributed to cold weather during the test. (The level of workers' familiarity to the operation can be considered the same between the tests since it had been repeated several times before time measurement)
- Radiation dose in the place where this operation is conducted is estimated to be 5 to 10 mSv/h. Dose reduction is important since a worker exposure of 2 to 3 mSv/person/operation is estimated.
- Efforts to shorten the operation time need to be made in the course toward the commencement of actual operation at the site, such as redesigning opening equipment



Worker protection equipment such as Tyvek clothing, full-face mask, and gloves	Core tube change time
Without protection equipment	10 to 17 minutes
With protection equipment	11 to 15 minutes

6. Implementation details of this project

6.2. Implementation details

2) Development of Element Technology for Retrieval Device Installation

(2) Development of Interference Object Removal during Fuel Debris Retrieval

b. Method to remove interfering objects by the fuel debris retrieval device designed for the side access method

(ii) Method and procedure used to enlarge existing openings in the PVC wall for enabling the entry of arm-type devices into the PCV

Stuck core tube release attempts and the number of successes

- Core tube stuck occurred in 44 through-hole opening cycles among a total of 117 cycles. (Occurrence rate was 38%.)
- Conventional style core tubes (threaded joint type) cannot be released by reverse turning once they get stuck. **Reversely turnable core tubes were able to be released remotely either by core tube withdrawal operation or reverse turning.** (Larger diameter opening was not needed to release stuck cores)
- **Figures in green letters are the numbers of successful stuck core release attempts with reversable core tubes among the all successful attempts. Boring attempts were made in areas with dense rebar to test stuck release methods because core tube stuck is likely to occur more often in those areas.**

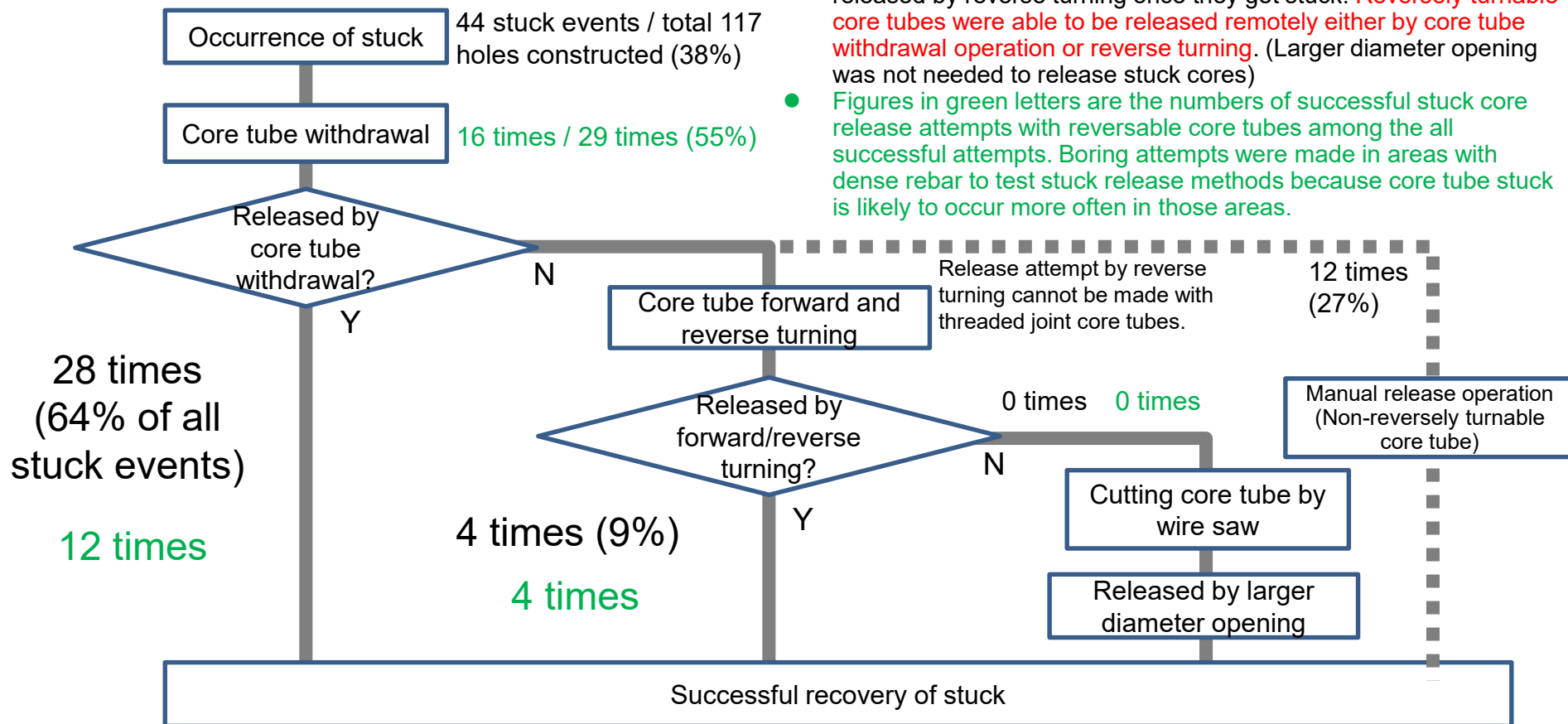

6. Implementation details of this project

6.2. Implementation details

2) Development of Element Technology for Retrieval Device Installation

(2) Development of Interference Object Removal during Fuel Debris Retrieval

b. Method to remove interfering objects by the fuel debris retrieval device designed for the side access method

(ii) Method and procedure used to enlarge existing openings in the PVC wall for enabling the entry of arm-type devices into the PCV

Stuck recovery by larger diameter opening

- It was tested to prepare for cases where stuck cannot be released by withdrawal operation or reverse turning.
- A coring bit whose diameter is larger than stuck cores is used to remove the stuck cores.
- Several combinations of different diameters and thicknesses of rescue core bits were tested to change the thickness of the sleeve cut out by them. (Figure on the right)
- Tests were performed for 8 stuck cases, and all were released by larger diameter opening. Average operation time was approx. 3 hours.
- The fracture of cut out sleeve occurred in 5 cases. Fracture tended to occur when the sleeve was thinner.
- Rescue core bit stuck occurred in 3 cases of these cases. Stuck was successfully released by withdrawal operation for all the cases (1 to 2 min/attempt)

Outside: Boring cores to release stuck cores
Inside: Stuck cores

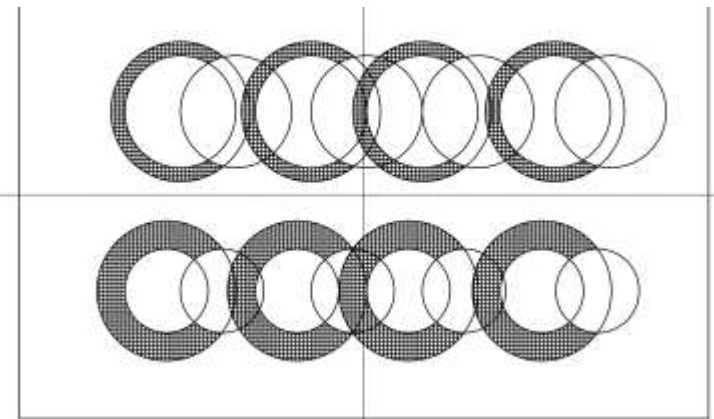

Simulated stuck cores

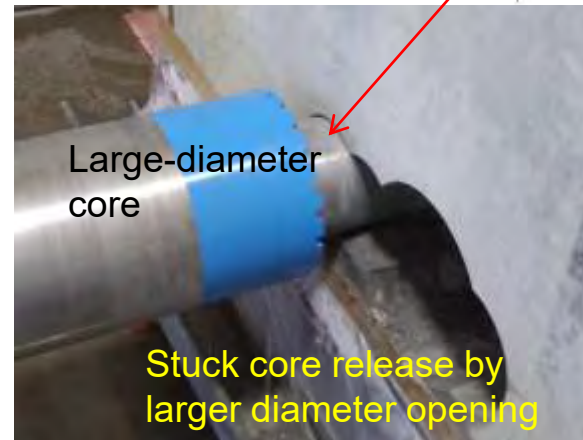

6. Implementation details of this project

6.2. Implementation details

2) Development of Element Technology for Retrieval Device Installation

(2) Development of Interference Object Removal during Fuel Debris Retrieval

b. Method to remove interfering objects by the fuel debris retrieval device designed for the side access method

(ii) Method and procedure used to enlarge existing openings in the PVC wall for enabling the entry of arm-type devices into the PCV

- The final dimensions of the BSW opening will be determined based on the achievable dimensional accuracy of the construction, seal installation accuracy, and so on.

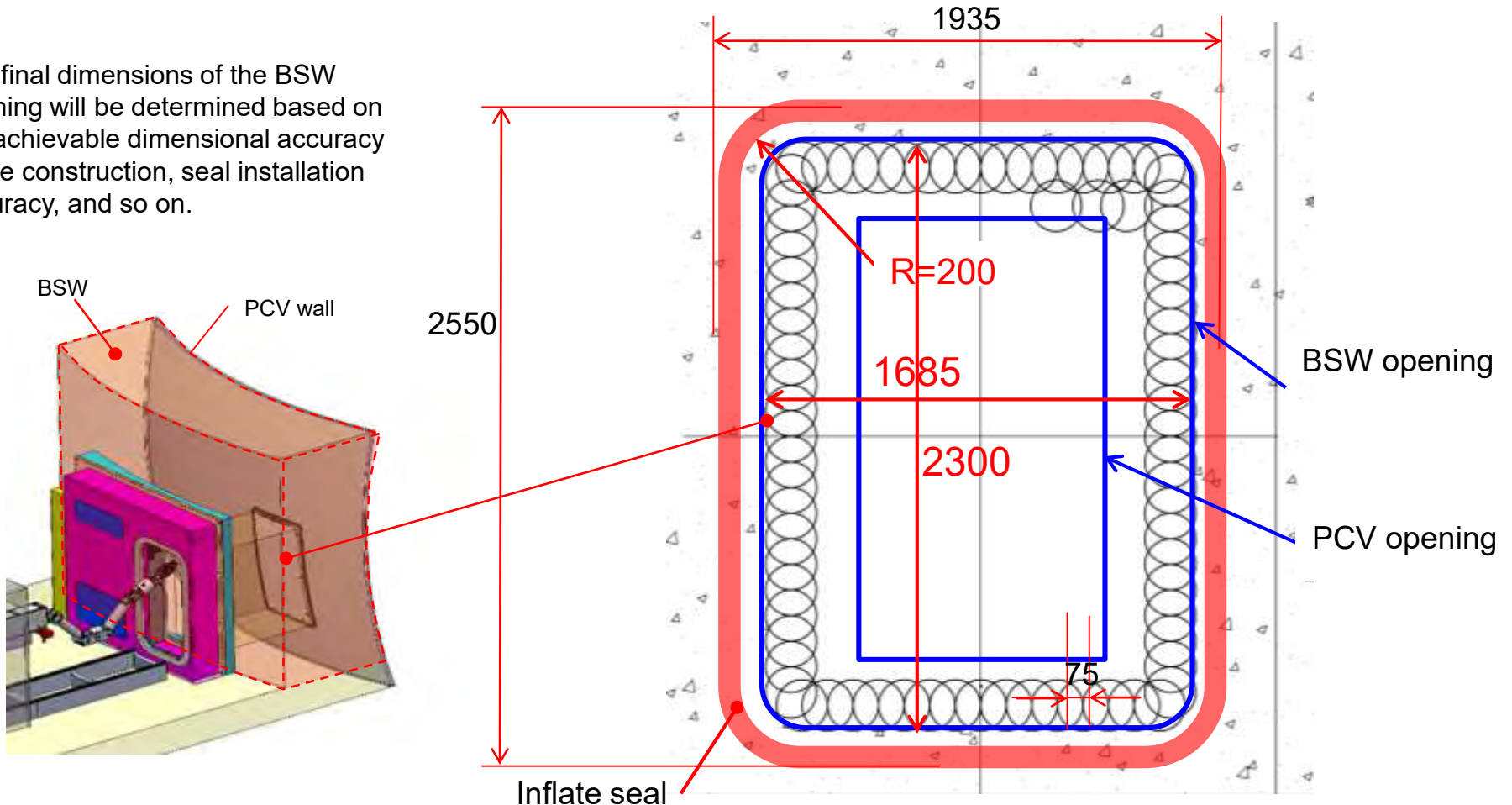

6. Implementation details of this project

6.2. Implementation details

2) Development of Element Technology for Retrieval Device Installation

(2) Development of Interference Object Removal during Fuel Debris Retrieval

b. Method to remove interfering objects by the fuel debris retrieval device designed for the side access method

(ii) Method and procedure used to enlarge existing openings in the PVC wall for enabling the entry of arm-type devices into the PCV

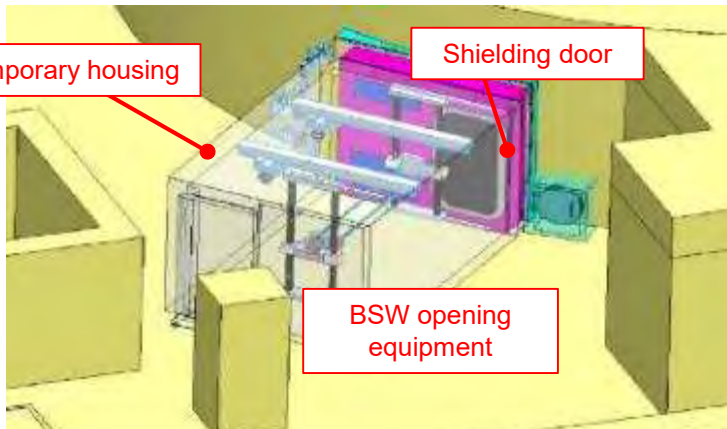

1. Temporary housing and BSW opening equipment installation

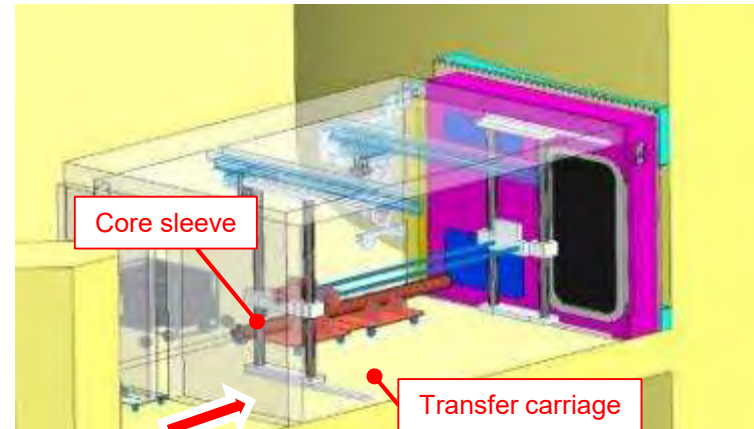

2. Transportation of core sleeve into temporary housing

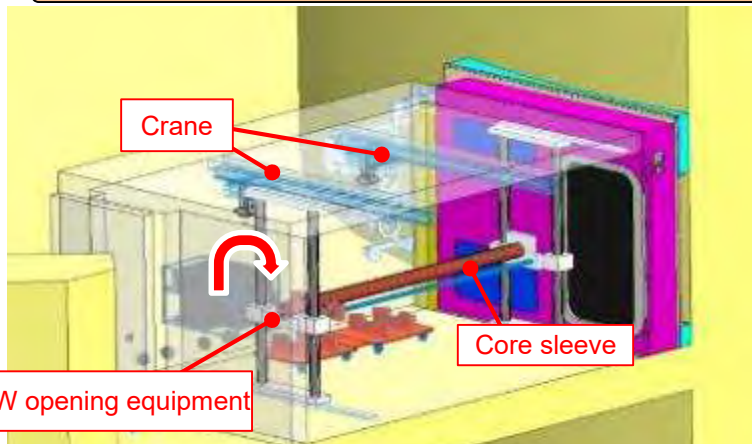

3. Core sleeve loading on BSW opening equipment

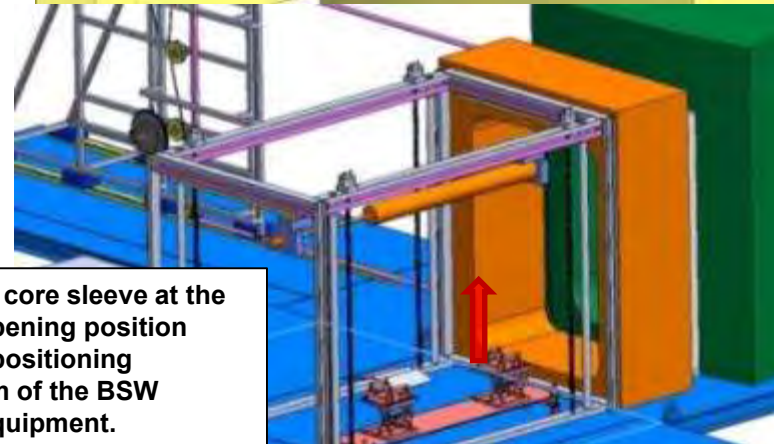

4. Positioning of BSW opening equipment

6. Implementation details of this project

6.2. Implementation details

2) Development of Element Technology for Retrieval Device Installation

(2) Development of Interference Object Removal during Fuel Debris Retrieval

b. Method to remove interfering objects by the fuel debris retrieval device designed for the side access method

(ii) Method and procedure used to enlarge existing openings in the PVC wall for enabling the entry of arm-type devices into the PCV

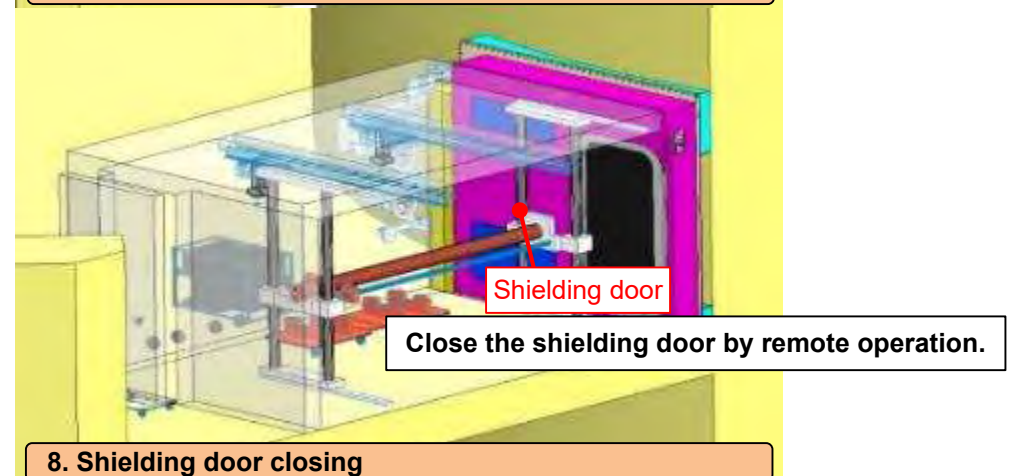
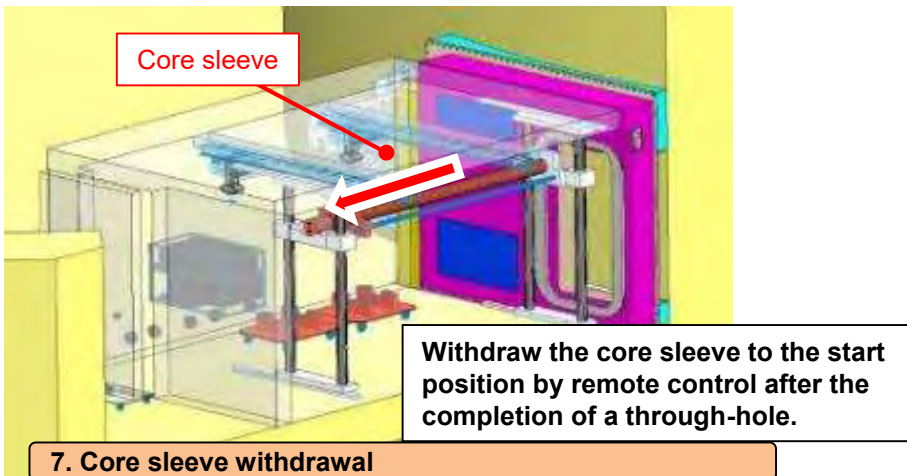
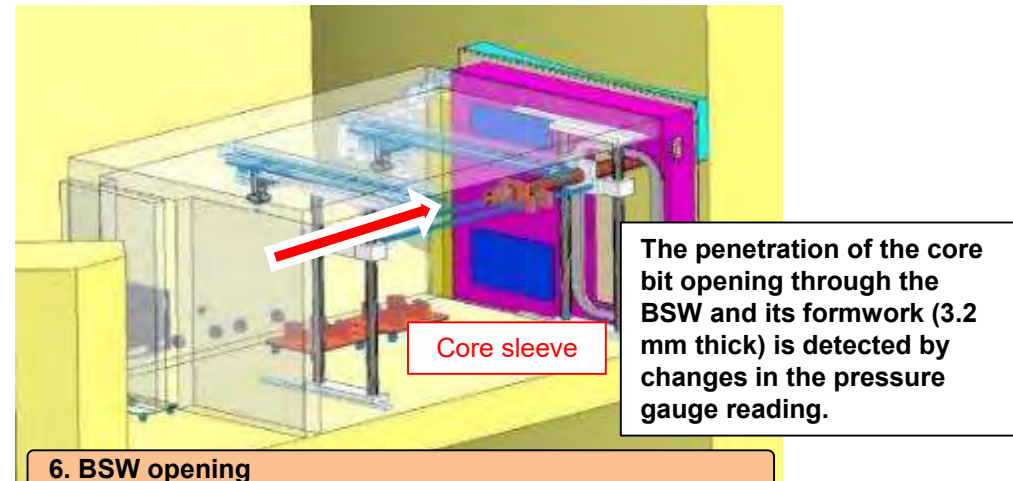
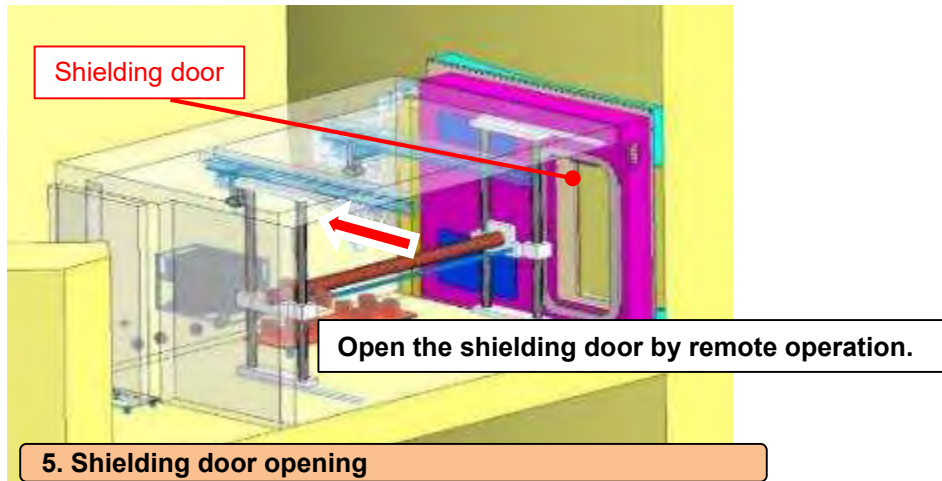

6. Implementation details of this project

6.2. Implementation details

2) Development of Element Technology for Retrieval Device Installation

(2) Development of Interference Object Removal during Fuel Debris Retrieval

b. Method to remove interfering objects by the fuel debris retrieval device designed for the side access method

(ii) Method and procedure used to enlarge existing openings in the PVC wall for enabling the entry of arm-type devices into the PCV

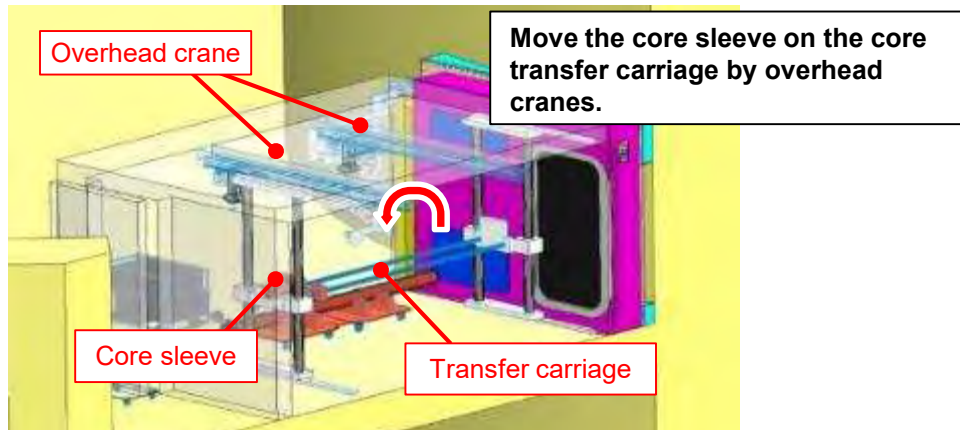

9. Loading of the core sleeve on the core transfer carriage

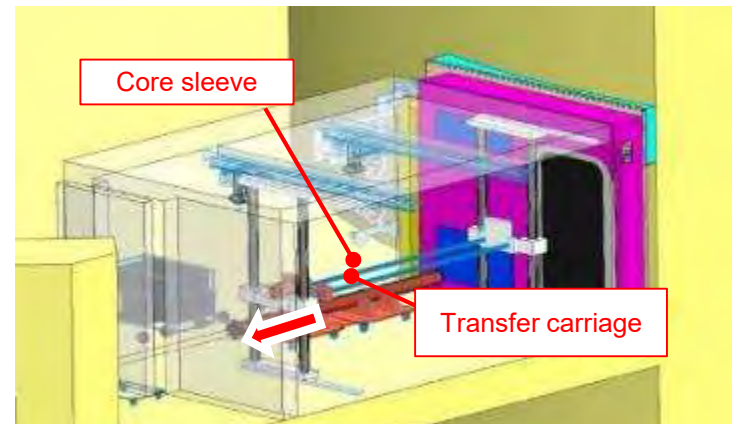

10. Transportation of the used core sleeve

Transport the used core sleeve outside the temporary housing.
* Repeat steps 2 to 10 in this order.

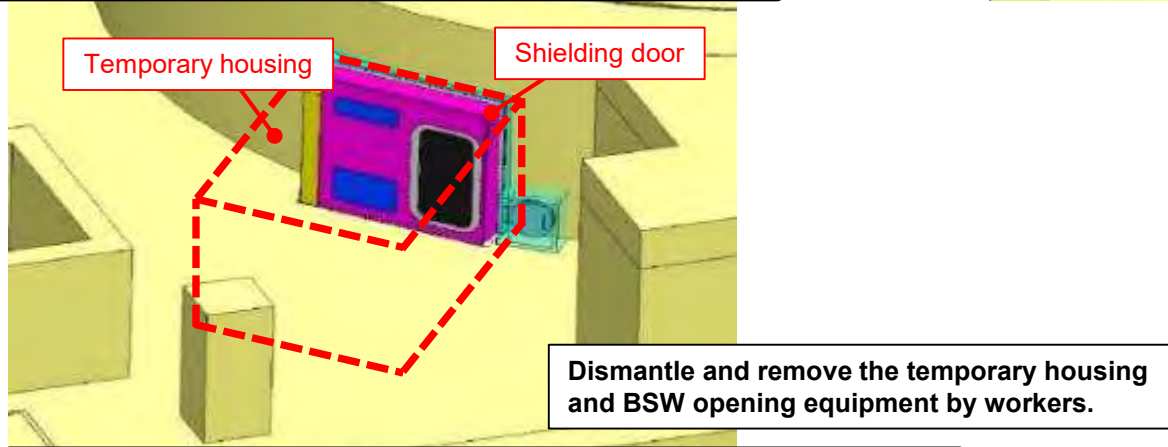

11. Dismantlement of temporary housing and BSW opening equipment

6. Implementation details of this project

6.2. Implementation details

2) Development of Element Technology for Retrieval Device Installation

(2) Development of Interference Object Removal during Fuel Debris Retrieval

b. Method to remove interfering objects by the fuel debris retrieval device designed for the side access method

(ii) Method and procedure used to enlarge existing openings in the PVC wall for enabling the entry of arm-type devices into the PCV

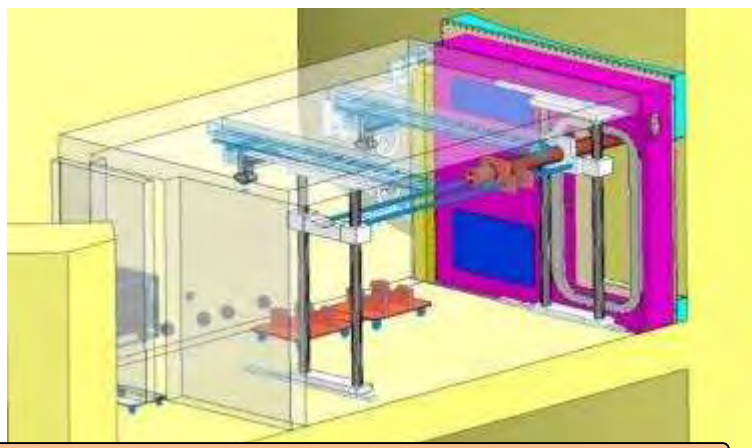

Recovery operation 1) Occurrence of core sleeve stuck

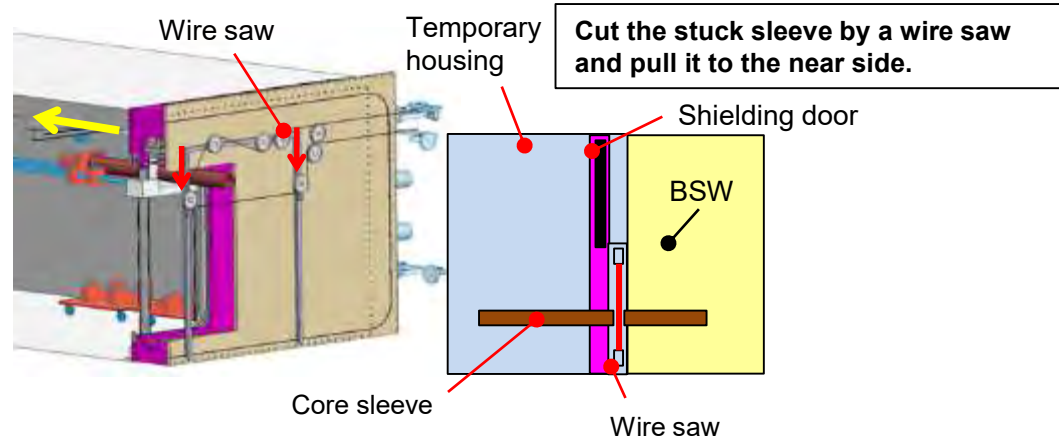

Recovery operation 2) Core sleeve cutting

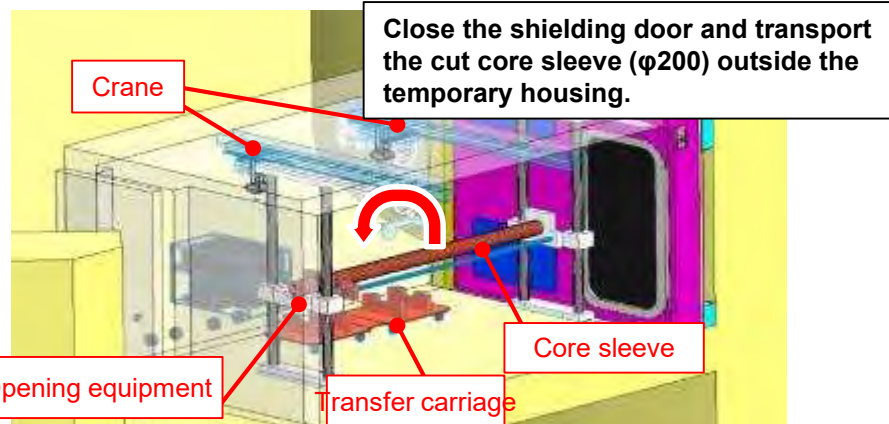

Recovery operation 3) Cut core sleeve removal

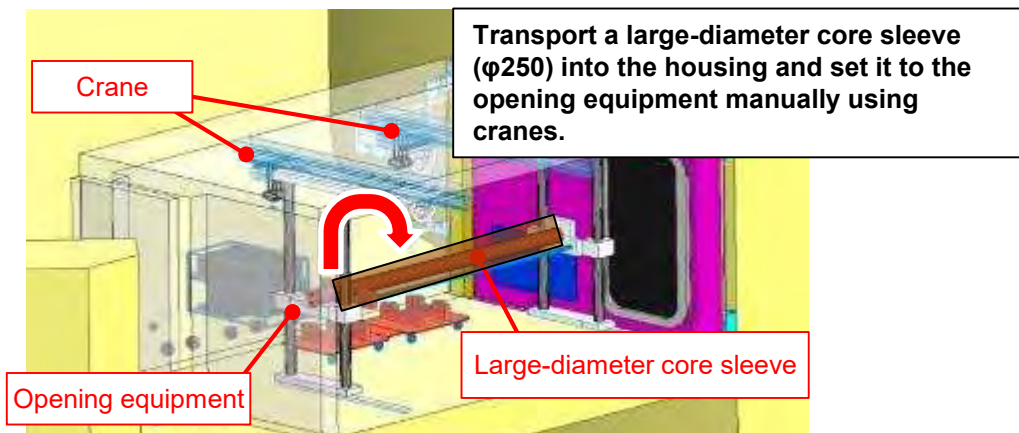

Recovery operation 4) Large-diameter core sleeve loading

6. Implementation details of this project

No.281

6.2. Implementation details

2) Development of Element Technology for Retrieval Device Installation

(2) Development of Interference Object Removal during Fuel Debris Retrieval

b. Method to remove interfering objects by the fuel debris retrieval device designed for the side access method

(ii) Method and procedure used to enlarge existing openings in the PVC wall for enabling the entry of arm-type devices into the PCV

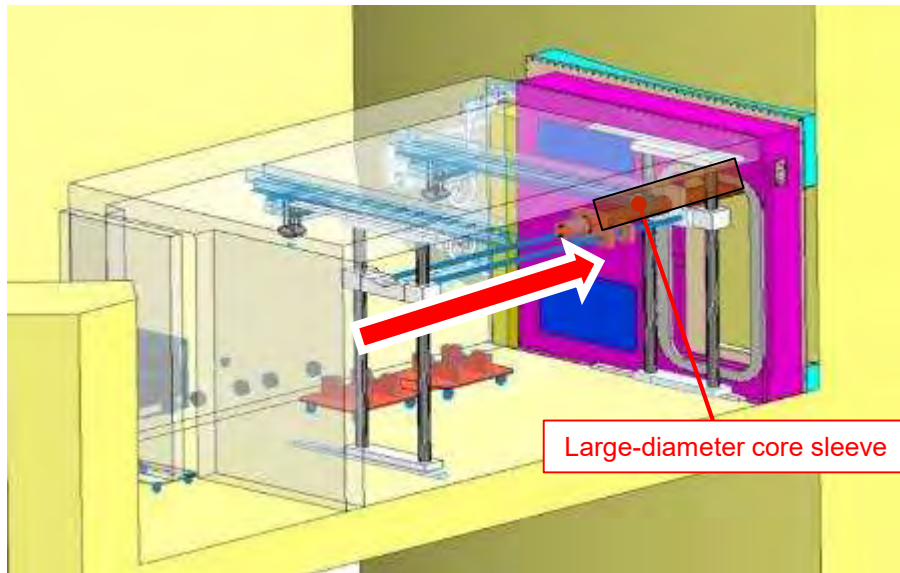

Recovery operation 5) Coring by large-diameter core sleeve

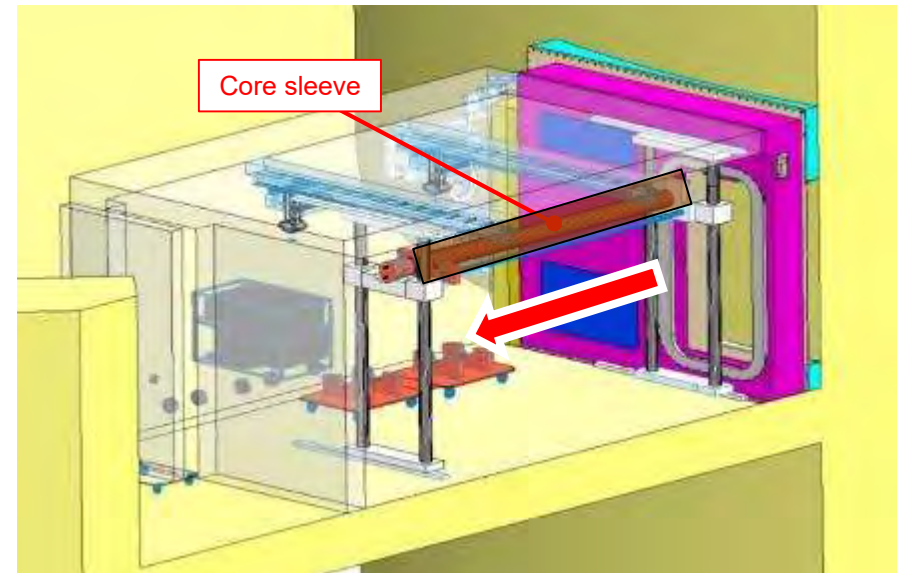

Recovery operation 6) Withdrawal of large-diameter core sleeve

Open the shielding door by remote control. Locate the large-diameter core sleeve at a position remotely so that it encompasses the core sleeve ($\phi 200$) stuck in the BSW in a concentric manner, turn and drive it forward into the BSW until its front end passes through the far end of the BSW and its formwork (3.2 mm thick). The completion of opening is detected by change in the pressure gauge reading.

6. Implementation details of this project

6.2. Implementation details

2) Development of Element Technology for Retrieval Device Installation

(2) Development of Interference Object Removal during Fuel Debris Retrieval

b. Method to remove interfering objects by the fuel debris retrieval device designed for the side access method

(ii) Method and procedure used to enlarge existing openings in the PVC wall for enabling the entry of arm-type devices into the PCV

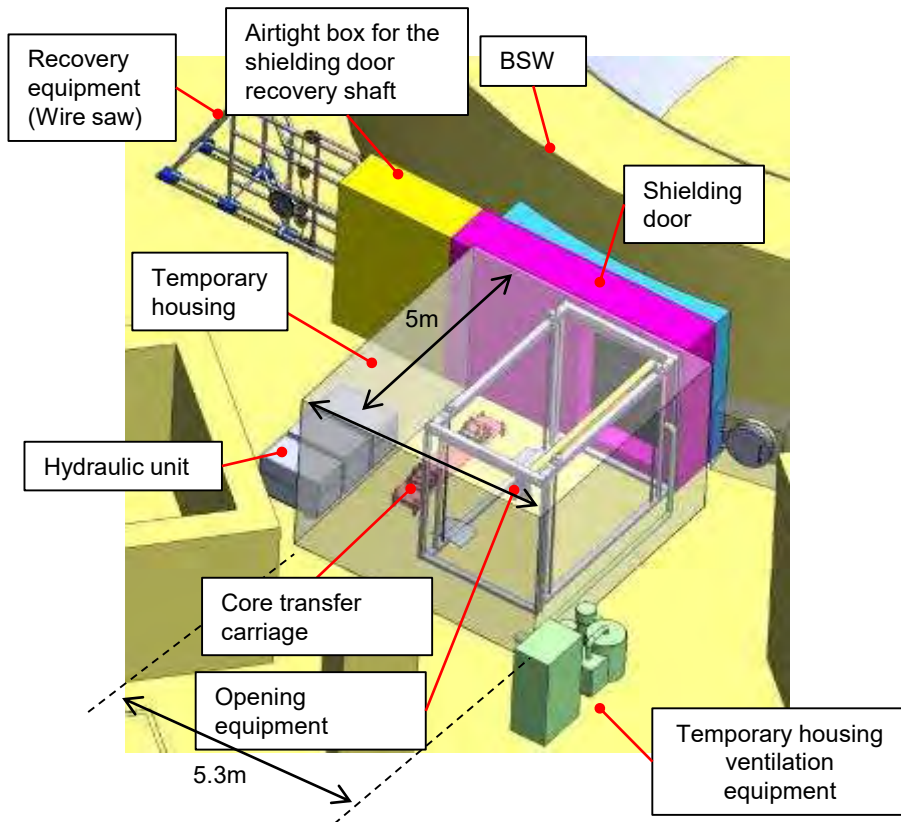

Equipment configuration and layout designed for the actual site

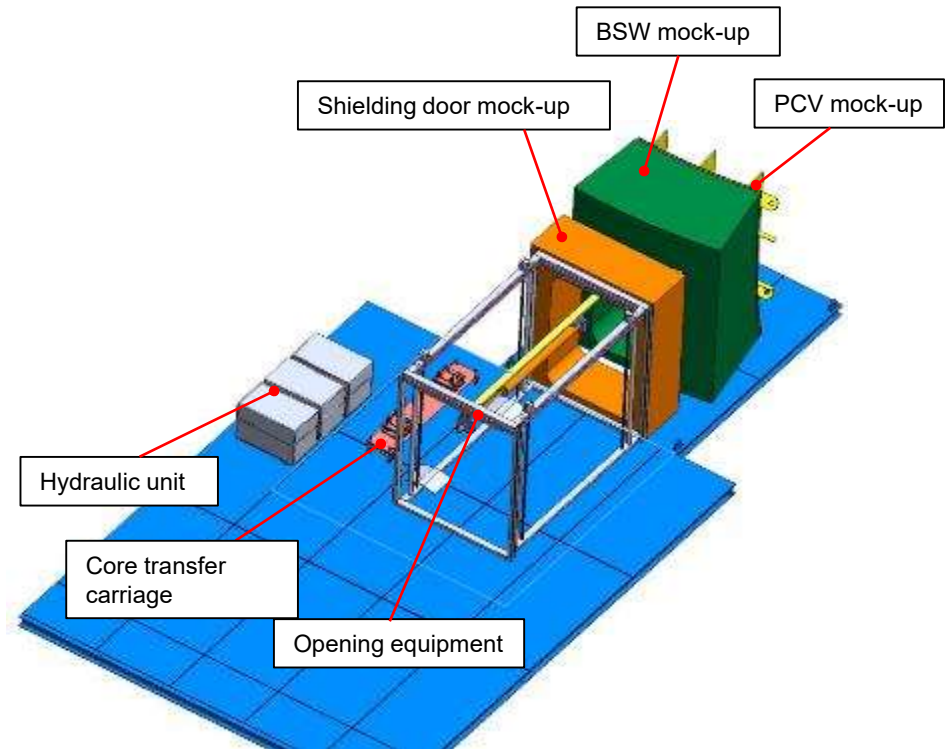

Configuration of components in the combination test

6. Implementation details of this project

6.2. Implementation details

2) Development of Element Technology for Retrieval Device Installation

(2) Development of Interference Object Removal during Fuel Debris Retrieval

b. Method to remove interfering objects by the fuel debris retrieval device designed for the side access method

(ii) Method and procedure used to enlarge existing openings in the PVC wall for enabling the entry of arm-type devices into the PCV

Structures and equipment		Element test (Combination test)	Actual operation at the site	Notes (differences between the mock-up and actual site)
BSW		Standard design strength: 51 N/mm ² Thickness: approx. 1,800 mm Rebar arrangement: D38-SD345 (two-layer-two-stage) Dimensions: outside radius of 11,700 mm and inside radius of 10,069 mm Formwork: 3.2 mm thick steel plate (one side)	Standard design strength: 225kg/cm ² (22 N/mm ²) Thickness: approx. 1,800 mm Rebar arrangement: D38-SD345 (two-layer-two-stage) Dimensions: outside radius of 11,700 mm and inside radius of 10,069 mm Formwork: 3.2 mm thick steel plate (one side)	The actual measurement of strength obtained by long-term deterioration tests is used.
Opening equipment	Core sleeve	φ 200 × 2,309 long (plan)	Same as on the left	—
	Drive unit	Hydraulic motor is used for both turning and linear motion.	Same as on the left	—
	Positioning unit	Positioning is automatically performed by an X-Y positioning system.	Same as on the left	—
	Large-diameter core	φ 250 × 2,309 long (plan)	Same as on the left	—
Core transfer carriage		Used for transportation and core sleeve change	Same as on the left	—
Recovery	Wire saw	It is installed between BSW and shielding door and used to cut a core sleeve.	It is installed between BSW and shielding door and used to cut a core sleeve.	—
Shielding door		Mock-up to simulate the dimensions of the opening	A door with shielding and sealing functions is installed.	Simulating the dimensions of the opening Thickness is 150 mm less than that of the actual reactor
Temporary housing		None	Yes	The maximum allowable area for the installation is marked on the floor.
Temporary housing ventilation		None	Yes	Because of no housing prepared
Cutting chips collection equipment and wastewater treatment equipment		It is used to collect sludge generated by opening operation (mixture of concrete cutting dust and water).	Same as on the left	About the same

6. Implementation details of this project

6.2. Implementation details

2) Development of Element Technology for Retrieval Device Installation

(2) Development of Interference Object Removal during Fuel Debris Retrieval

b. Method to remove interfering objects by the fuel debris retrieval device designed for the side access method

(ii) Method and procedure used to enlarge existing openings in the PVC wall for enabling the entry of arm-type devices into the PCV

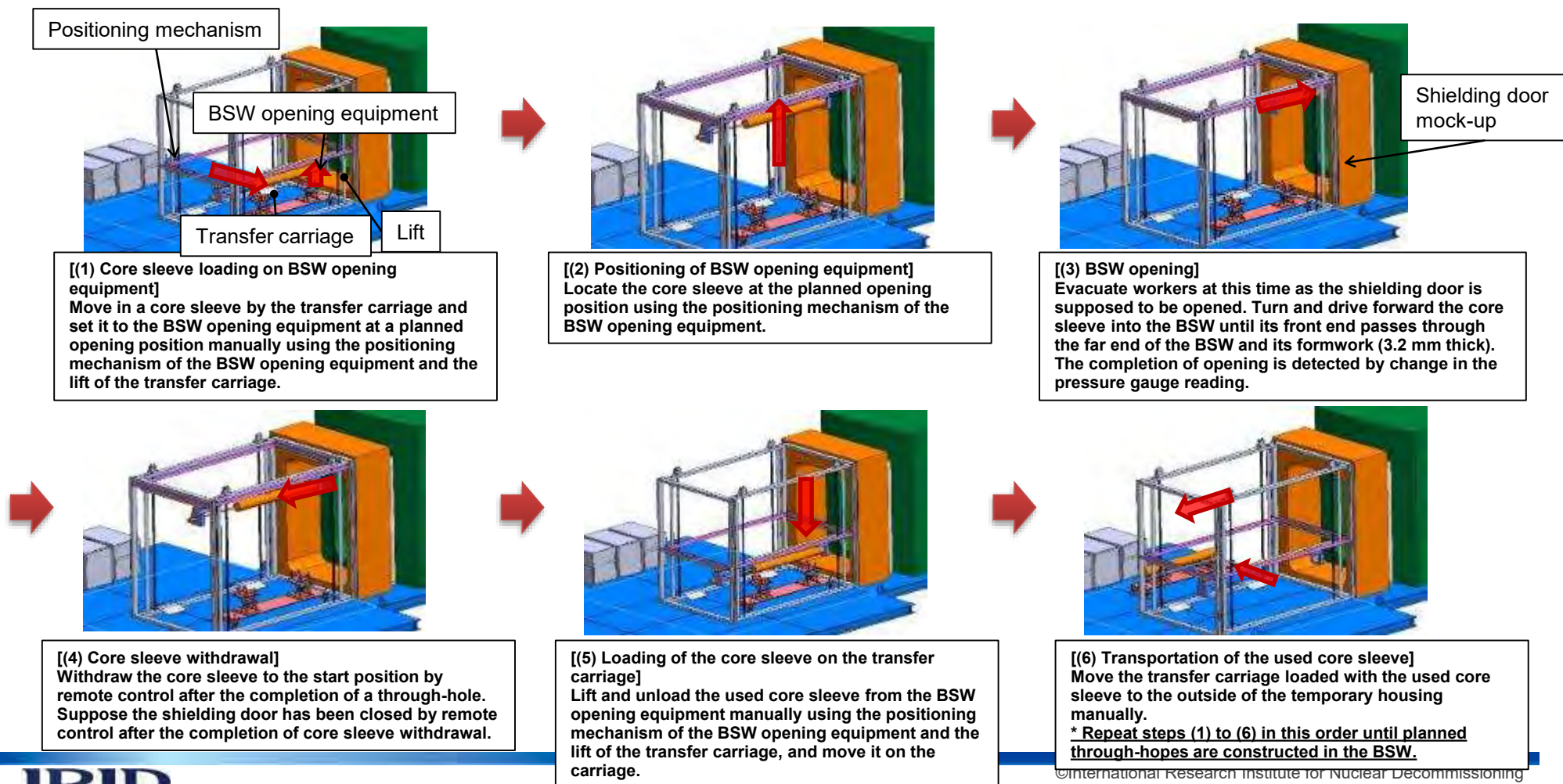

6. Implementation details of this project

6.2. Implementation details

2) Development of Element Technology for Retrieval Device Installation

(2) Development of Interference Object Removal during Fuel Debris Retrieval

b. Method to remove interfering objects by the fuel debris retrieval device designed for the side access method

(ii) Method and procedure used to enlarge existing openings in the PVC wall for enabling the entry of arm-type devices into the PCV

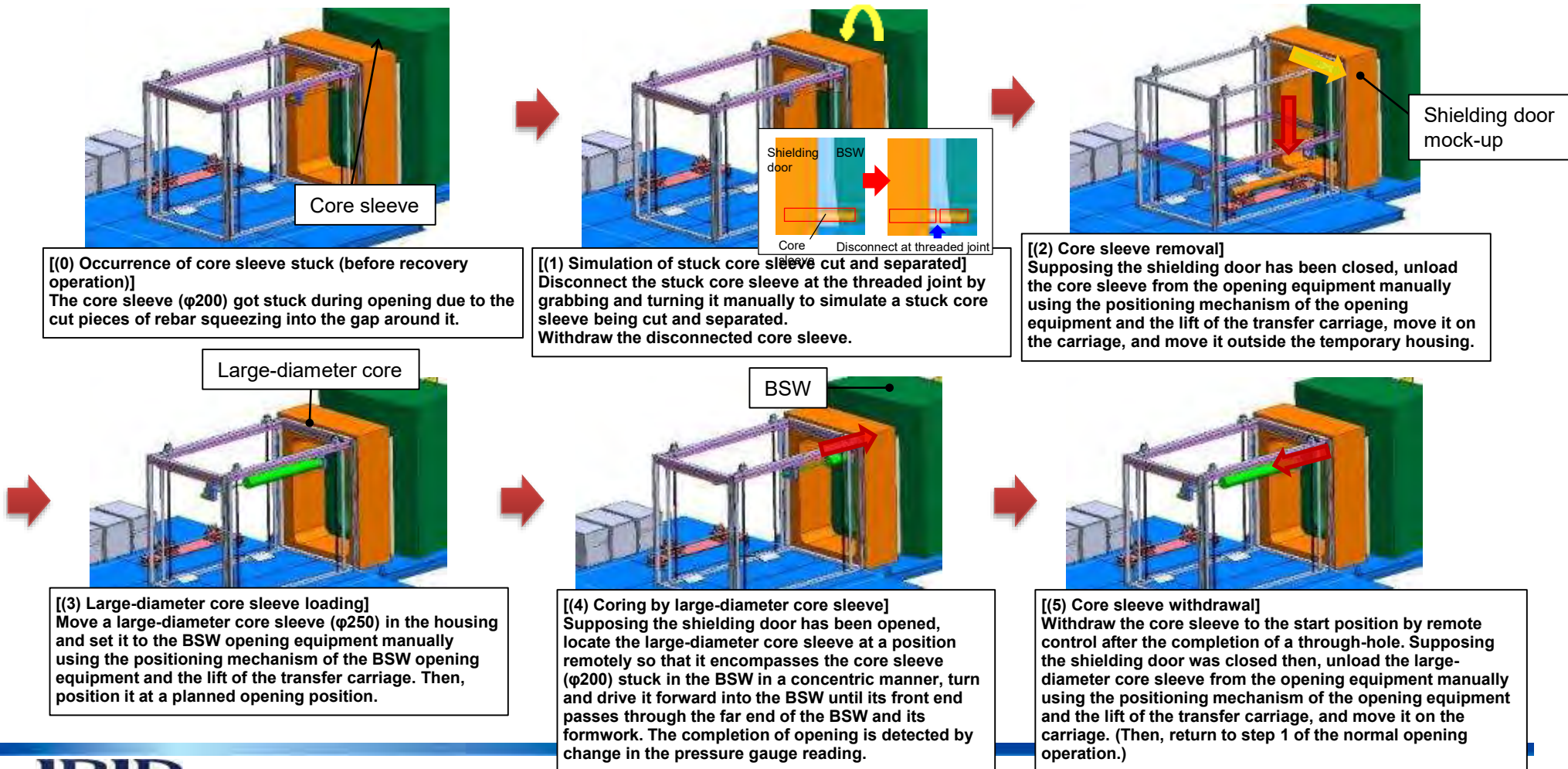

6. Implementation details of this project

No.286

6.2. Implementation details

2) Development of Element Technology for Retrieval Device Installation

(2) Development of Interference Object Removal during Fuel Debris Retrieval

b. Method to remove interfering objects by the fuel debris retrieval device designed for the side access method

(ii) Method and procedure used to enlarge existing openings in the PVC wall for enabling the entry of arm-type devices into the PCV

Phase	No.	Process control parameters
1) BSW opening operation		
Temporary housing and BSW opening equipment installation	1-1	Installation position and levelness of the temporary housing and BSW opening equipment
Transportation of a core sleeve	2-1	Confirmation of the completion of transportation
Core sleeve loading on the BSW opening equipment	3-1	Boring start position (coordinate)
Shielding door opening	4-1	Shielding door open/close dimensions and position (coordinate)
BSW opening	5-1	(1) Core sleeve overshoot distance after reaching the far end of the wall PCV (primary boundary) shall not be damaged. The following items shall be monitored to check the progress of opening: · Hydraulic pressure gauge of the core sleeve drive unit · Color of wastewater, opening noise · Advancement of the core bit (coordinate)
Core sleeve withdrawal	6-1	Core sleeve position (coordinate)
Shielding door closing	7-1	Shielding door position (coordinate)
Loading of a core sleeve on the transfer carriage	8-1	Loading position of a core sleeve on the carrier
Transportation of a used core sleeve	9-1	Confirmation of the completion of transportation outside the housing
Temporary housing and BSW opening equipment dismantlement and removal	10-1	Confirmation of removal outside the R/B
2) Stuck core sleeve release operation		
Core sleeve cutting	11-1	Cutting device position (coordinate)
Core sleeve withdrawal	12-1	Core sleeve position (coordinate)
Large-diameter core sleeve loading	13-1	* Same as 3-1 above
Coring by large-diameter core sleeve	14-1	Same as 5-1 above
Core sleeve withdrawal	15-1	Core sleeve position (coordinate)

6. Implementation details of this project

No.287

6.2. Implementation details

2) Development of Element Technology for Retrieval Device Installation

(2) Development of Interference Object Removal during Fuel Debris Retrieval

b. Method to remove interfering objects by the fuel debris retrieval device designed for the side access method

(ii) Method and procedure used to enlarge existing openings in the PVC wall for enabling the entry of arm-type devices into the PCV

Verification item	Data	Notes
BSW opening	An opening to allow the entry of the fuel debris retrieval device was successfully constructed by opening. The dimensions of the constructed opening were the followings against the targets of 1,685 mm for short side and 2,300 mm for long side: 1,682 to 1,695 mm for short side and 2,303 to 2,308 mm for long side on the near side (outer wall of BSW); and 1,681 to 1,699 mm for short side and 2,297 to 2,312.5 mm for long side on the far side (PCV-side wall). Max. dimensional error was 0.5%.	Operation parameters Rotation speed: 204 rpm Hydraulic pressure (gauge reading): 5 to 10 MPa Cooling water: 4 L/min
Operation time per hole	1 h 55 min/hole (Max. 2 h 56 min, Min. 1 h 13 min)	
Weigh of generated dust	The weight of generated dust was measured. Single opening: 47.7 mg (surface part); 3.3 mg (intermediate part); and 0.2 mg (rear part) Continuous opening: 6.1 mg (surface part); 13.8 mg (intermediate part); and 39.2 mg (rear part)	Dispersion factor of airborne dust 0.002 to 0.028%
Discharge volume (cell side)	Near side (outer wall of BSW): 353.4 L/hole (Dust of 3.4 L/hole is included) Far side (PCV side): 54.6 L/hole (Dust of 0.6 L/hole is included)	
Stuck occurrence frequency	Stuck occurred mainly due to the cut pieces of rebar squeezing into the gap around the core sleeve. (Occurred in 26 out of 75 holes bored)	
Test and verification of the feasibility of stuck recovery methods	It was demonstrated to be adequate to execute the following methods in this order until the stuck core sleeve is released: 1) turn the core sleeve reversely, (2) cut the stuck core sleeve, and (3) larger diameter opening to cut out the stuck core sleeve together with the wall. It was also confirmed that all these methods were workable.	
Core boring bit change and carrying in/out operation time	Boring bit change and carrying in/out procedures were simulated and tested to measure the operation time. The operation time was 11 to 15 min/cycle. Based on this data, worker exposure was estimated to be 2 to 3 mSv/person.	Workers wore protection equipment during the test.
Issues to be addressed before starting actual construction at the site and in designing devices	<ul style="list-style-type: none"> Burrs on the edge of the BSW formwork (max. 10 mm), and peel of the formwork (max. 7 mm) It was demonstrated in the inflate seal installation test that the burrs and peel could be removed. Data to design removal equipment was also obtained. Deposit of cutting chips in the gap between the BSW and PCV and on the floor of the opening construction place, fall of the cut pieces of the BSW formwork Reduction of worker exposure during core sleeve change operation 	

6. Implementation details of this project

6.2. Implementation details

2) Development of Element Technology for Retrieval Device Installation

(2) Development of Interference Object Removal during Fuel Debris Retrieval

b. Method to remove interfering objects by the fuel debris retrieval device designed for the side access method

(ii) Method and procedure used to enlarge existing openings in the PVC wall for enabling the entry of arm-type devices into the PCV

- Outcomes of this project
 - BSW opening tests were performed with a BSW mock-up, and it was demonstrated that an opening to allow the entry of the fuel debris retrieval device could be constructed by a core boring method.
 - 1 h 55 min/hole (Max. 2 h 56 min, Min. 1 h 13 min)
 - The dimensional error of the constructed opening was max. 0.5% (actual long side measurement of 2,312.5 mm) against the targets of 1,685 mm for short side and 2,300 mm for long side.
 - Suitable operation parameters were sought, and the following conditions were demonstrated to be good for successful opening.
 - Rotation speed: 204 rpm, hydraulic pressure (gauge reading): 5 to 10 MPa, and cooling water: 4 L/min
 - It was found that approx. 11% (54.6 L) of wastewater and cutting chips generated by opening (total 408 L/hole) flew to the PCV side as an average. Issues to be addressed before starting actual construction at the site, such as flow prevention measures by leaving the formwork untouched, were identified
 - The dispersion factor of airborne dust was demonstrated to be from 0.002% to 0.028%.
- Issues (to be addressed in the design phase of devices and equipment for actual construction at the site)

	Issues	Action policy
1	Burrs on the cut edge of the formwork (max. 10 mm), and its deformation such as peel (max. 7 mm)	Removing burrs and deformed parts by a grinder or the like before installing inflate seals (Workability was demonstrated in the inflate seal installation test.)
		Designing sealing equipment applicable to a narrow gap
		Leaving the formwork untouched and cutting and dismantling it separately in the last step
2	Reduction of wastewater flowing to the PCV side	Remove cutting chips before installing inflate seals
3	Dose reduction during core sleeve change operation	Frame structure change

6. Implementation details of this project

6.2. Implementation details

2) Development of Element Technology for Retrieval Device Installation



(2) Development of Interference Object Removal during Fuel Debris Retrieval

c. Method to remove interfering objects by the fuel debris retrieval devices commonly designed for both the access methods

Interfering objects that need to be removed were listed along with relevant information.

 : Element tests were performed.

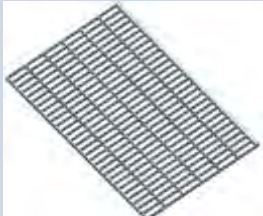
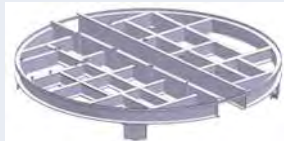
* Degree of difficulty scores in the table are based on relative evaluation

No.	Interfering objects	Outline specifications	Proposed processing methods	Examples of removal methods	Degree of difficulty of removal*	Notes
1	Grating 	Main material SS + fuel debris	Disc cutter, sabre saw	① Cut by a disc cutter or the like. ② Put cut pieces in a container and move them out (through the equipment hatch).	Medium	· With fuel debris adhering to it · It is estimated to have an odd shape due to deformation and melting.
2	Grating support structure 	Main material SS + fuel debris	Disc cutter, sabre saw	① Cut by a disc cutter or the like. ② Put cut pieces in a container and move them out (through the equipment hatch).	High	· With fuel debris adhering to it · It is estimated to have an odd shape due to deformation and melting.
3	CRD, etc. (fallen objects) 	Main material SUS + fuel debris	Disc cutter, sabre saw	① Cut by a disc cutter or the like. ② Put cut pieces in a container and move them out (through the equipment hatch).	High	· With fuel debris adhering to it · <u>The presence of objects that have fallen from reactor internals was estimated.</u> · It is estimated to have an odd shape due to deformation and melting.

6. Implementation details of this project

6.2. Implementation details

2) Development of Element Technology for Retrieval Device Installation

(2) Development of Interference Object Removal during Fuel Debris Retrieval

c. Method to remove interfering objects by the fuel debris retrieval devices commonly designed for both the access methods

Interfering objects that need to be removed were listed along with relevant information.

: Element tests were performed.

* Degree of difficulty scores in the table are based on relative evaluation

No.	Interfering objects	Outline specifications	Proposed processing methods	Examples of removal methods	Remove operation*	Notes
4	CRD replacement equipment 	Main material SS + aluminum + SUS + fuel debris	Disc cutter, sabre saw	① Cut by a disc cutter or the like. ② Put cut pieces in a container and move them out (through the equipment hatch).	High	· Fuel debris adhering to it · It is estimated to have an odd shape due to deformation and melting.

The element test will be performed to evaluate the feasibility of the series of operations, including cutting and removing target interfering objects, putting the cut pieces in a container, and transporting the container from the inside of the pedestal to the outside, all of which take into consideration object fall prevention measures. The test will be performed using mock-ups that are designed and built to meet the purpose of the test.

6. Implementation details of this project

6.2. Implementation details

2) Development of Element Technology for Retrieval Device Installation

(2) Development of Interference Object Removal during Fuel Debris Retrieval

c. Method to remove interfering objects by the fuel debris retrieval device commonly designed for both the access methods

(i) Method and procedure to cut and remove interfering objects in the pedestal

Elemental tests are planned for testing methods and procedure to cut and remove fallen objects and structures in the pedestal. These tests are performed to evaluate methods and procedure commonly applicable to both the top and side access methods as well as to any types of interfering objects that do not require special methods.

- Purpose of development
 - Feasibility demonstration of cutting work in a narrow place
 - Feasibility demonstration of processing methods that take into consideration object fall prevention measures

- Issues to be solved
 - Operability of remote operation
 - Cutting methods applicable to narrow places
 - Removal methods that take into consideration object fall prevention measures

- Expected outcome
 - Verification of the feasibility of installing equipment in narrow places
 - Feasibility of processing methods that take into consideration object fall prevention measures
 - Feasibility of the entire process from cutting target interfering objects, putting the cut pieces in a container, and transporting the container from the inside of the pedestal to the outside.
 - Study of throughput.

6. Implementation details of this project

6.2. Implementation details

2) Development of Element Technology for Retrieval Device Installation

(2) Development of Interference Object Removal during Fuel Debris Retrieval

c. Method to remove interfering objects by the fuel debris retrieval devices commonly designed for both the access methods

(i) Method and procedure to cut and remove interfering objects in the pedestal

The illustration of the element test to evaluate the removal method of fallen objects in the pedestal is shown below.

- Reasons of the selection of sections reproduced in the test mock-up
- ① There is a high probability of reactor bottom structures having fallen and lying in the pedestal (according to the result of 1F-3 PCV inside investigation).
 - ② When target interfering objects lie near the pedestal opening, removal of them will be difficult because the range of the movement of the removal device is limited.

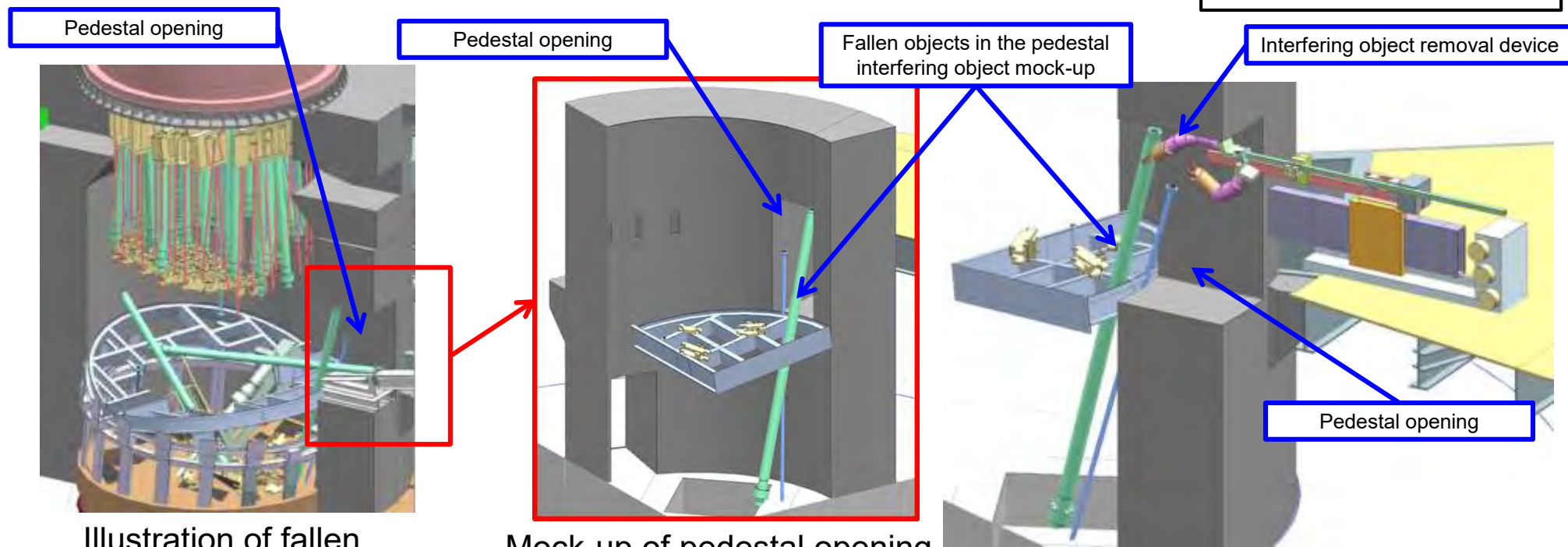

Illustration of fallen objects in the pedestal

Mock-up of pedestal opening section and its vicinity

Illustration of element tests for interfering object removal

: Object reproduced in the element test mock-up

6. Implementation details of this project

6.2. Implementation details

2) Development of Element Technology for Retrieval Device Installation

(2) Development of Interference Object Removal during Fuel Debris Retrieval

c. Method to remove interfering objects by the fuel debris retrieval devices commonly designed for both the access methods

(i) Method and procedure to cut and remove interfering objects in the pedestal

The overview of the development and the procedures is provided.

No.	Removal of interfering objects in the pedestal Phase	Details of study and objective of tests (Confirmation items)	Element test	Notes
1	Transportation of the interfering object removal device	The interfering object removal device consists of many components. All of them shall be able to be transported into the PCV and transported near the pedestal opening.	○	
2	Assembly of the interfering object removal device	The components of the interfering object removal device shall be able to be put together, and the assembled device shall be able to be installed at the pedestal opening, using remote-controlled equipment.	○	
3	Investigation of conditions in the pedestal	Conditions in the pedestal, such as the damage of internal structures and shapes and positions of target interfering objects, shall be able to be investigated using cameras mounted on the interfering object removal device.	○	
4	Removal of interfering objects near the pedestal opening	The arms of the interfering object removal device shall be able to go inside the pedestal so that they can manipulate, cut and remove target interfering objects while fall prevention measures are implemented for cut pieces.	○	
5	Removal of the cut pieces of interfering objects	Cut pieces of interfering objects shall be able to be put in a collection container.	○	
6	Transportation of collection container	The collection container with the cut pieces of interfering objects shall be able to be transported outside the pedestal and transferred to the transportation route to the outside of the PCV.	○	
7	Removal of interfering objects in the pedestal	The extendable boom of the interfering object removal device shall be controlled effectively according to the distance to target interfering objects in the pedestal, so that they shall be reached, cut and removed by the arms of the device, while fall prevention measures are implemented for cut pieces.	○	
8	Collection and transportation of the cut pieces of interfering objects	Cut pieces of interfering objects shall be able to be put in a collection container, and the container shall be able to be transported outside the pedestal and transferred to the transportation route to the outside of the PCV.	○	

6. Implementation details of this project

6.2. Implementation details

2) Development of Element Technology for Retrieval Device Installation

(2) Development of Interference Object Removal during Fuel Debris Retrieval

c. Method to remove interfering objects by the fuel debris retrieval devices commonly designed for both the access methods

(i) Method and procedure to cut and remove interfering objects in the pedestal

Work steps of the removal of interfering objects in the pedestal were studied to identify necessary functions for the operation and potential issues.

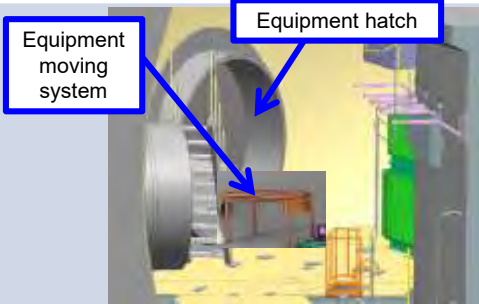
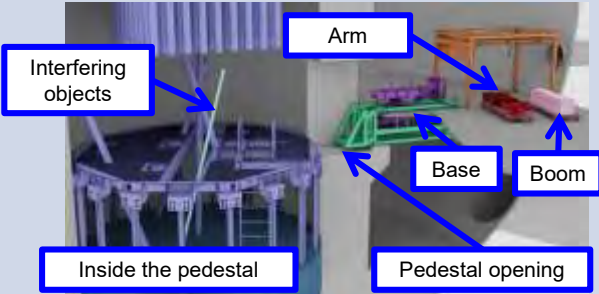
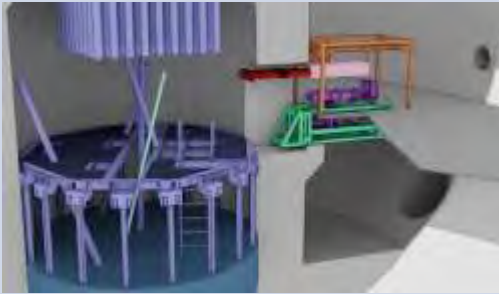
Work step	A. Transporting the interfering object removal device into the PCV	B. Moving the interfering object removal device to the pedestal opening	C. Assembling the interfering object removal device (Repeat)
Illustration of operation	 <p>Equipment moving system</p> <p>Equipment hatch</p>	 <p>Interfering objects</p> <p>Arm</p> <p>Base</p> <p>Boom</p> <p>Inside the pedestal</p> <p>Pedestal opening</p>	
Description	Transporting the components of the interfering object removal device into the PCV	Transporting the components of the interfering object removal device near the pedestal opening by the equipment moving system	Assembling the components of the interfering object removal device together by remote control
Functional requirements	The components shall be able to be transported into the PCV.	The components shall be able to be transported near the pedestal opening.	The interfering object removal device shall be able to be assembled and installed.

6. Implementation details of this project

6.2. Implementation details

2) Development of Element Technology for Retrieval Device Installation

(2) Development of Interference Object Removal during Fuel Debris Retrieval

c. Method to remove interfering objects by the fuel debris retrieval devices commonly designed for both the access methods

(i) Method and procedure to cut and remove interfering objects in the pedestal

Work steps of the removal of interfering objects in the pedestal were studied to identify necessary functions for the operation and potential issues.

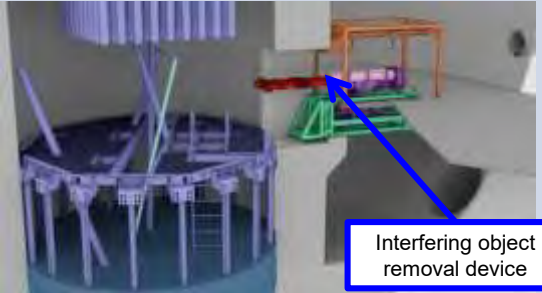
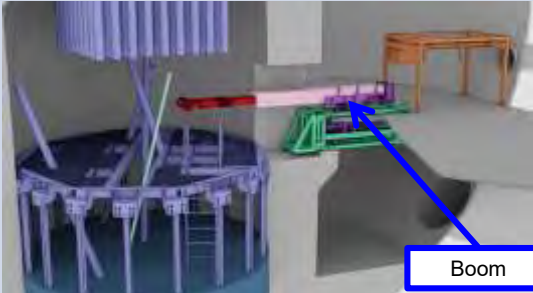
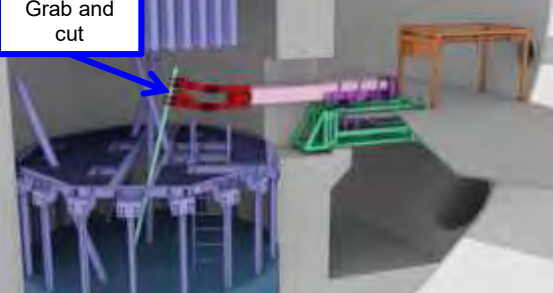
Work step	D. Investigating conditions in the pedestal	E. Manipulating the arms of the device to interfering objects near the pedestal opening	F. Cutting and removing interfering objects near the pedestal opening (atmospheric and underwater work)
Illustration of operation			
Description	Investigating conditions in the pedestal, such as the damage of internal structures and shapes and positions of target interfering objects, by cameras and the like before sending the arms of the device in the pedestal	Sending the arms of the device in the pedestal and manipulating them to target interfering objects	Performing cutting and removal work while implementing fall prevention measures for interfering objects
Functional requirements	Internal conditions of the pedestal shall be able to be investigated before sending the arms in it	The arms of the device shall be able to be manipulated to interfering objects.	<ul style="list-style-type: none"> Interfering objects shall be able to be cut and removed without causing them to fall The device shall have a cutting tool operable in a narrow place

6. Implementation details of this project

6.2. Implementation details

2) Development of Element Technology for Retrieval Device Installation

(2) Development of Interference Object Removal during Fuel Debris Retrieval

c. Method to remove interfering objects by the fuel debris retrieval devices commonly designed for both the access methods

(i) Method and procedure to cut and remove interfering objects in the pedestal

Work steps of the removal of interfering objects in the pedestal were studied to identify necessary functions for the operation and potential issues.

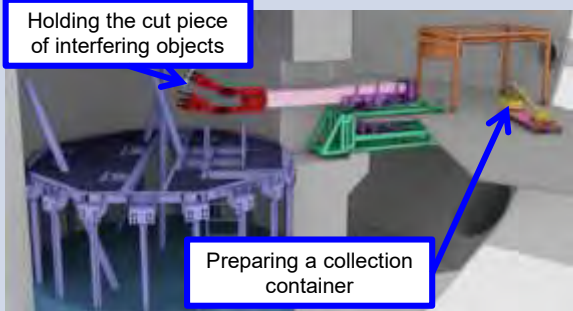
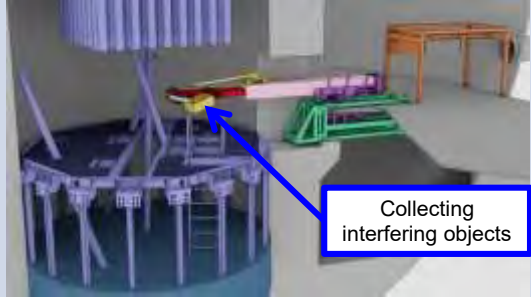
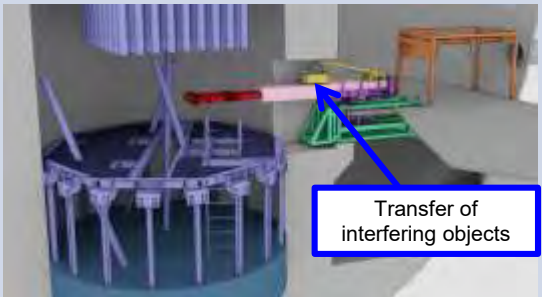
Work step	G. Preparing an interfering objects collection container	H. Storing interfering objects in the collection container	I. Transporting the collection container outside the pedestal
Illustration of operation			
Description	Preparing a collection container to hold and transport the cut pieces of interfering objects from the inside of the pedestal to the outside	Storing the cut pieces of interfering objects removed with the interfering object removal device in the collection container	Transporting the collection container from the inside of the pedestal to the outside
Functional requirements	The collection container shall be able to be transported into the pedestal.	Cut pieces of interfering objects shall be able to be put in the collection container.	The collection container with interfering objects shall be able to be transported outside the pedestal.

6. Implementation details of this project

6.2. Implementation details

2) Development of Element Technology for Retrieval Device Installation

(2) Development of Interference Object Removal during Fuel Debris Retrieval

c. Method to remove interfering objects by the fuel debris retrieval devices commonly designed for both the access methods

(i) Method and procedure to cut and remove interfering objects in the pedestal

Work steps of the removal of interfering objects in the pedestal were studied to identify necessary functions for the operation and potential issues.

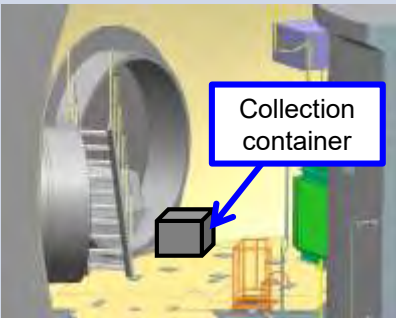
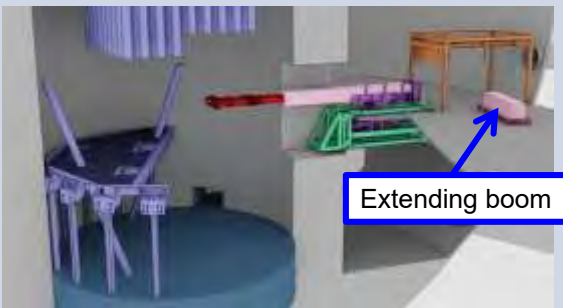
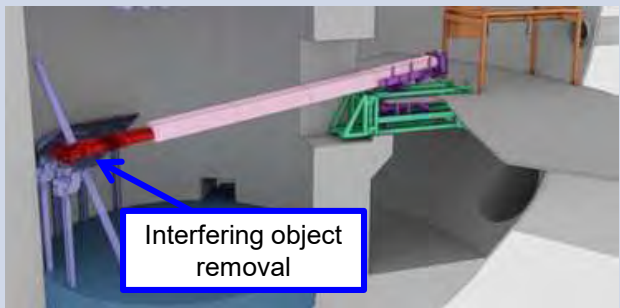
Work step	J. Transporting the collection container outside the PCV	K. Extending the boom for the interfering object removal device	L. Removing interfering objects farthest from the opening (Same manner as that for those near the opening)
Illustration of operation			
Description	J. Transferring the collection container to the transportation route to the outside of the PCV	Adjusting the length of the extendable boom of the interfering object removal device according to the distance to target interfering objects	Repeating work steps F to K to remove interfering objects in the pedestal
Functional requirements	The collection container shall be able to be transported.	The length of the extendable boom shall be adjustable.	-

6. Implementation details of this project

6.2. Implementation details

2) Development of Element Technology for Retrieval Device Installation

(2) Development of Interference Object Removal during Fuel Debris Retrieval

c. Method to remove interfering objects by the fuel debris retrieval devices commonly designed for both the access methods

(i) Method and procedure to cut and remove interfering objects in the pedestal

Based on the result of the study on work steps of the removal of interfering objects in the pedestal and on functional requirements for each identified step, the specifications of the interfering object removal device were developed and potential issues associated with the operation were identified.

Step	Functional requirements	Basic specifications of the device	Predictable issues during operation
A	The components shall be able to be transported into the PCV.	The components shall be designed and built to have dimensions and weight so that they can be transported into the PCV through the opening of the equipment hatch (1.5 m square) and put on the grating (loading capacity of 500 kg/m ²).	Transportation of the components from the outside of the PCV to the inside
B	The components shall be able to be transported near the pedestal opening.	The components shall be designed and built to have dimensions and weight so that they can be transported near the pedestal opening through the aisle beside the PLR pump (1.8 m wide) and put on the grating (loading capacity of 500 kg/m ²).	<ul style="list-style-type: none"> · Transportation of the components to the pedestal opening area · Accidents during the components' transportation (fall, stuck, etc.)
C	The interfering object removal device shall be able to be assembled and installed.	The components shall be able to be located at planned installation positions, mounted, and assembled.	<ul style="list-style-type: none"> · Troubles in joints (stuck, deformation, etc.) · Component positioning method
D	Internal conditions of the pedestal shall be able to be investigated before sending the arms in it.	Observation sensors (camera, etc.) shall be able to be mounted.	Installation of observation sensors in the pedestal
E	The arms of the device shall be able to be manipulated to interfering objects.	Cutting positions of target interfering objects shall be able to be determined.	Positioning of the cutting tool at suitable cutting positions of interfering objects

6. Implementation details of this project

6.2. Implementation details

2) Development of Element Technology for Retrieval Device Installation

(2) Development of Interference Object Removal during Fuel Debris Retrieval

c. Method to remove interfering objects by the fuel debris retrieval devices commonly designed for both the access methods

(i) Method and procedure to cut and remove interfering objects in the pedestal

Based on the result of the study on work steps of the removal of interfering objects in the pedestal and on functional requirements for each identified step, the specifications of the interfering object removal device were developed and potential issues associated with the operation were identified.

Step	Functional requirements	Basic specifications of the device	Predictable issues during operation
F	Interfering objects shall be able to be cut and removed without causing them to fall.	Fall prevention measures shall be implemented for interfering objects.	Fall of cut pieces
	The device shall have a cutting tool operable in a narrow place.	<ul style="list-style-type: none"> The unit shall have a cutting tool capable of cutting estimated interfering objects. The cutting tool shall be replaceable. Interference objects shall be able to be cut into a size that fits into a planned collection container ($\phi 390$ mm \times 400 mm, similar to the UC considered by the collection and storage working group). 	<ul style="list-style-type: none"> Cutting of interfering objects into pieces of a required size or smaller Cutting tool replacement method
G	The collection container shall be able to be transported into the pedestal.	<ul style="list-style-type: none"> Transportation of the collection containers shall be provided. A collection container shall be provided with dimensions which allow it to pass through the pedestal opening (0.79m \times 1.97m) for round trip between the inside and the outside of the pedestal and yet to hold the cut pieces of interfering objects. The collection container shall be designed to have a size that can contain the cut pieces of interfering objects ($\phi 390$ mm \times 400 mm, similar to the UC considered by the collection and storage working group). 	<ul style="list-style-type: none"> Method to collect cut pieces in a collection container Method to recover from collection container fall or stuck accidents Cut pieces fall from a collection container
H	Cut pieces of interfering objects shall be able to be put in the collection container.		
I	The collection container with interfering objects shall be able to be transported outside the pedestal.		

6. Implementation details of this project

6.2. Implementation details

2) Development of Element Technology for Retrieval Device Installation

(2) Development of Interference Object Removal during Fuel Debris Retrieval

c. Method to remove interfering objects by the fuel debris retrieval devices commonly designed for both the access methods

(i) Method and procedure to cut and remove interfering objects in the pedestal

Based on the result of the study on work steps of the removal of interfering objects in the pedestal and on functional requirements for each identified step, the specifications of the interfering object removal device were developed and potential issues associated with the operation were identified.

Step	Functional requirements	Basic specifications of the device	Predictable issues during operation
J	The collection container shall be able to be transported.	<ul style="list-style-type: none"> · A collection container transportation means shall be provided. · The collection container shall be designed to have a size that can be transferred from near the pedestal opening to the transportation route to the outside of the PCV ($\phi 390$ mm \times 400 mm, similar to the UC considered by the collection and storage working group), and weight (50 kg as a currently planned loading capacity of the container transportation system per trip). 	<ul style="list-style-type: none"> · Accidents during the collection container transportation (fall, stuck, etc.)
K	The length of the extendable boom shall be adjustable.	<ul style="list-style-type: none"> · The device shall be equipped with an extendable boom. · Cutting positions of target interfering objects shall be able to be determined. 	<ul style="list-style-type: none"> · Troubles in joints (stuck, deformation, etc.) · Locating interfering objects
L			
Common	All devices and tools shall be able to be operated remotely.	A series of operations shall be able to be performed remotely, including the removal device assembly, arms manipulation to target interfering objects, and removal of cut pieces.	Remote operation while monitoring the condition of the device and environment in work area
	A monitoring means shall be provided to enable remote operation.	A monitoring means shall be provided to ensure clear images of points and areas needed for each operation.	Provision of the images of points and areas needed for each operation

6. Implementation details of this project

6.2. Implementation details

2) Development of Element Technology for Retrieval Device Installation

(2) Development of Interference Object Removal during Fuel Debris Retrieval

c. Method to remove interfering objects by the fuel debris retrieval devices commonly designed for both the access methods

(i) Method and procedure to cut and remove interfering objects in the pedestal

Potential issues were identified for each step of the removal of interfering objects inside the pedestal in the previous work. In this section, it was considered whether element tests were needed to address the issues and what was to be evaluated in the element tests.

Step	Predictable issues during operation	Conceptual study	Element test	Concrete actions	Confirmation items in element tests
A	Transportation of the components from the outside of the PCV to the inside	○	—	Desk engineering work to estimate dimensional and weight restrictions according to transportation routes and methods to the outside of the PCV	—
B	Transportation of the components to the pedestal opening area	○	○	Prototyping a components transportation system and measuring the time needed for transportation as reference data	Transportation time (as reference data)
	Accidents during the components' transportation (fall, stuck, etc.)	○	—	Identifying potential failures in addition to issues found in the above element test, developing recovery methods from the identified failures/issues through desk engineering work, and reflecting the result to the device specifications	—
C	Troubles in joints (stuck, deformation, etc.)	○	—	Identifying potential failures in addition to issues found in the assembly test, developing recovery methods from the identified failures/issues through desk engineering work, and reflecting the result to the device specifications	—
	Component positioning method	○	○	Performing components positioning operation by remote control and studying procedures and monitoring methods	<ul style="list-style-type: none"> · Installation time · Assembly procedures · Assembly time
D	Installation of observation sensors in the pedestal	○	○	Study of the installation positions of sensors required to investigate the conditions of interfering objects in the pedestal	Observation sensor installation position
E	Positioning of the cutting tool at suitable cutting positions of interfering objects	○	○	Development of a method to position the cutting tool at target cutting positions in a narrow environment	<ul style="list-style-type: none"> · Positioning procedures · Positioning time

6. Implementation details of this project

6.2. Implementation details

2) Development of Element Technology for Retrieval Device Installation

(2) Development of Interference Object Removal during Fuel Debris Retrieval

c. Method to remove interfering objects by the fuel debris retrieval devices commonly designed for both the access methods

(i) Method and procedure to cut and remove interfering objects in the pedestal

Potential issues were identified for each step of the removal of interfering objects inside the pedestal in the previous work. In this section, it was considered whether element tests were needed to address the issues and what was to be evaluated in the element tests.

Step	Predictable issues during operation	Conceptual study	Element test	Concrete actions	Confirmation items in element tests
F	Fall of cut pieces	○	○	Evaluation of cut piece fall prevention measures by tests	Interfering object grabbing method
	Cutting of interfering objects into pieces of a required size or smaller	○	○	Development of interfering object processing methods applicable to narrow environment	Interfering object cutting time
	Cutting tool replacement method	○	—	Studying the life of cutting tools and methods to change them through element tests and desk engineering work	—
G H I	Method to collect cut pieces in a collection container	○	○	Measurement of time required to collect cut pieces in a collection container	Cut piece collection time
	Method to recover from collection container fall or stuck accidents	○	—	Identifying potential failures in addition to issues found in the above element test, developing recovery methods from the identified failures/issues through desk engineering work, and reflecting the result to the device specifications	—
	Cut pieces fall from a collection container	○	—	Desk study of measures for issues identified in the cut piece collection test as well as of cut pieces fall prevention measures and reflection of the study result to the design of the collection method	—

6. Implementation details of this project

6.2. Implementation details

2) Development of Element Technology for Retrieval Device Installation

(2) Development of Interference Object Removal during Fuel Debris Retrieval

c. Method to remove interfering objects by the fuel debris retrieval devices commonly designed for both the access methods

(i) Method and procedure to cut and remove interfering objects in the pedestal

Potential issues were identified for each step of the removal of interfering objects inside the pedestal in the previous work. In this section, it was considered whether element tests were needed to address the issues and what was to be evaluated in the element tests.

Step	Predictable issues during operation	Conceptual study	Element test	Concrete actions	Confirmation items in element tests
J	· Accidents during the collection container transportation (fall, stuck, etc.)	○	—	Identifying potential failures in addition to issues found in tests, developing recovery methods from the identified failures/issues through desk engineering work, and reflecting the result to the device specifications	Collection container transportation time
K L	Troubles in joints (stuck, deformation, etc.)	○	—	Identifying potential failures in addition to issues found in the assembly test, developing recovery methods from the identified failures/issues through desk engineering work, and reflecting the result to the device specifications	—
	Locating interfering objects	○	○	Development of a method to expand the arms reachable range of the removal device and estimation of reachable range	· Arm reachable range expansion procedures · Operation time of arm reachable range expanding operation
Common	Remote operation while monitoring the condition of the device and environment in work area	○	○	Identification of functions required for remote operation in each work step	Identification of potential issues arising from each remote operation
	Provision of the images of points and areas needed for each operation	○	○	Determination of monitoring methods and monitoring areas suitable for each work step	· Camera installation positions · Number of cameras

6. Implementation details of this project

6.2. Implementation details

2) Development of Element Technology for Retrieval Device Installation

(2) Development of Interference Object Removal during Fuel Debris Retrieval

c. Method to remove interfering objects by the fuel debris retrieval devices commonly designed for both the access methods

(i) Method and procedure to cut and remove interfering objects in the pedestal

Confirmation items of the element tests and criteria used to assess the feasibility of operations were studied.

No.	Test item	Relevant work steps	Test procedures	Evaluation criteria	Data and information to be obtained
1	Preparation of the interfering object removal device	A, B, C, K	Transport the components into the PCV and assemble the interfering object removal device.	The interfering object removal device shall be able to be installed at a planned position.	<ul style="list-style-type: none"> · Components transportation time · Installation time · Assembly procedures · Assembly time
2	Interfering object removal (in the air)	D, E, F, L	Cut target interfering objects without causing them to fall.	The cutting tool shall be able to be positioned at planned cutting positions of interfering objects and cut them.	<ul style="list-style-type: none"> · Positioning procedures · Positioning time · Interfering object grabbing method · Interfering object cutting time
3	Interfering object removal (Underwater)	D, E, F, L	The evaluation of these steps for underwater cutting and removal work, including cutting tool positioning time and cutting time measurement, are skipped because data obtained in test item No.2 (atmospheric) is used. Only test item No.4 (cut pieces collection) is tested.		
4	Transfer of interfering objects	G, H, I, J	Transfer the collection container containing cut pieces of interfering objects to the transportation route.	The container shall be able to be transferred to the transportation route.	<ul style="list-style-type: none"> · Cut piece collection time · Collection container transportation time
5	Remote operation and monitoring test	Common	Carry out the operation of each step remotely while monitoring the operation using camera images.	All operations of above-listed tests shall be able to be monitored by cameras and carried out remotely.	<ul style="list-style-type: none"> · Identifying potential issues arising from the remote operation of each step · Camera installation positions · Number of cameras

6. Implementation details of this project

6.2. Implementation details

2) Development of Element Technology for Retrieval Device Installation

(2) Development of Interference Object Removal during Fuel Debris Retrieval

c. Method to remove interfering objects by the fuel debris retrieval devices commonly designed for both the access methods

(i) Method and procedure to cut and remove interfering objects in the pedestal

A mock-up for tests in the pedestal was designed and built to reproduce fallen objects as well as to enable underwater cutting and removal tests.

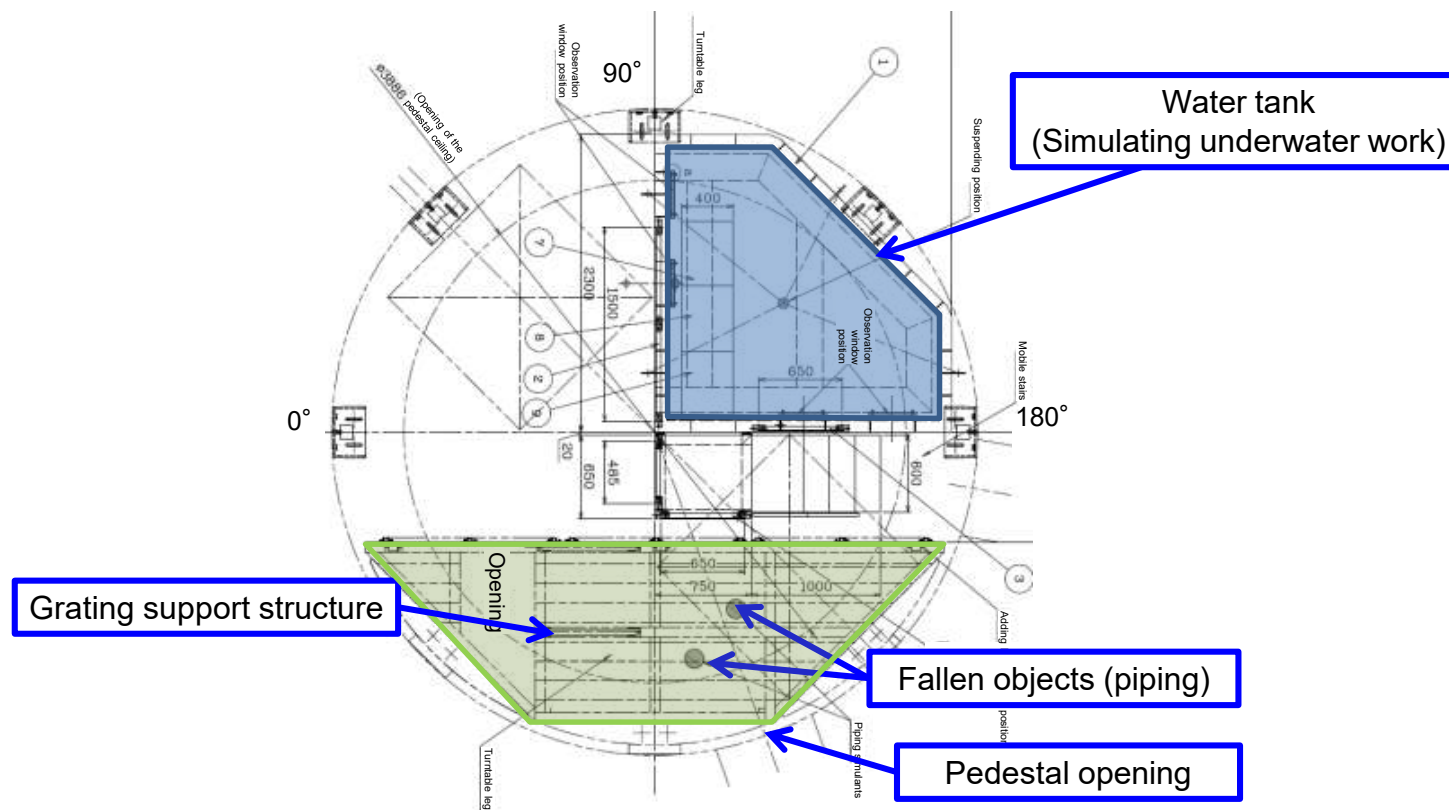

Drawing of pedestal inside mock-up plan

6. Implementation details of this project

6.2. Implementation details

2) Development of Element Technology for Retrieval Device Installation

(2) Development of Interference Object Removal during Fuel Debris Retrieval

c. Method to remove interfering objects by the fuel debris retrieval devices commonly designed for both the access methods

(i) Method and procedure to cut and remove interfering objects in the pedestal

Photos of the simulated mock-up (pedestal opening and water tank) used for the cutting and removal test of interfering objects in the pedestal are shown below.

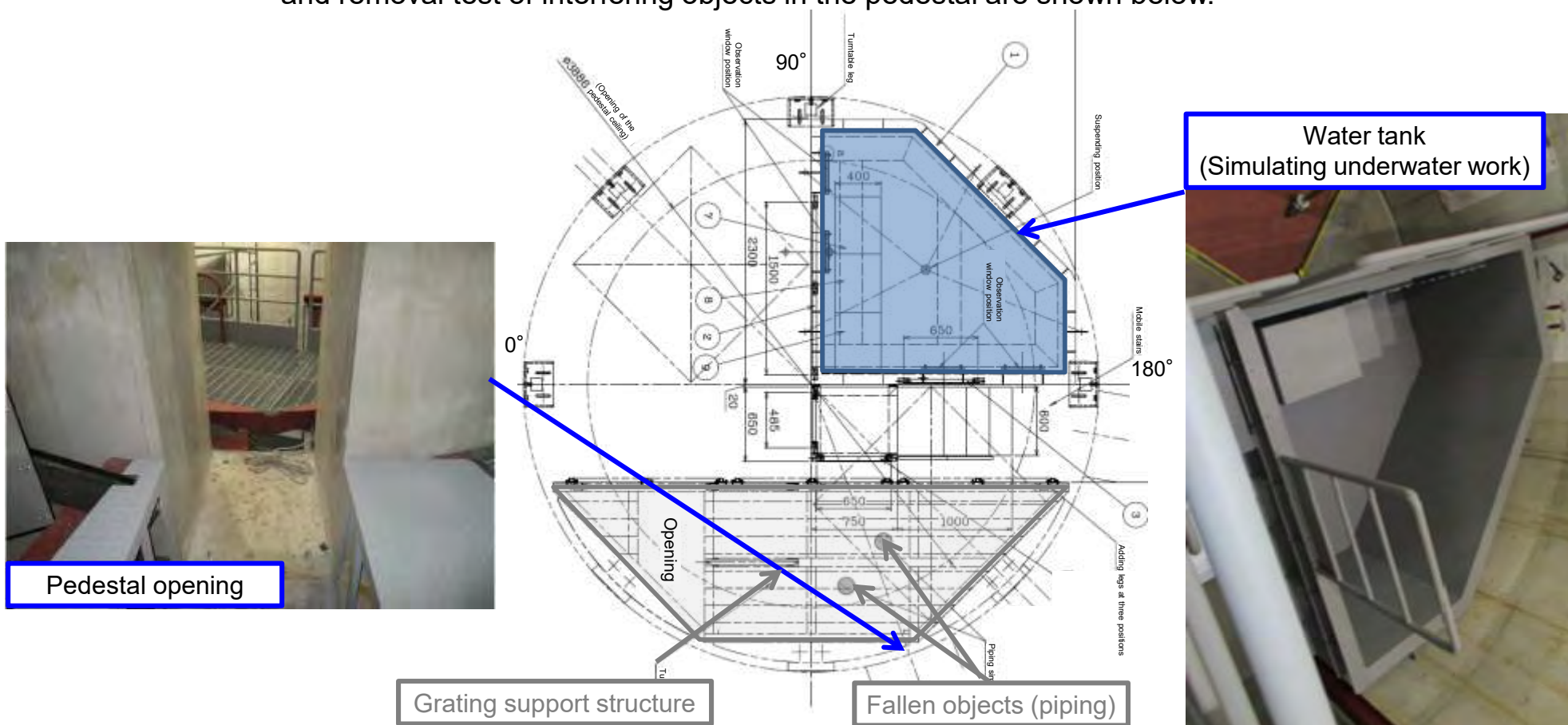

Pedestal opening

Water tank
(Simulating underwater work)

Grating support structure

Fallen objects (piping)

6. Implementation details of this project

6.2. Implementation details

2) Development of Element Technology for Retrieval Device Installation

(2) Development of Interference Object Removal during Fuel Debris Retrieval

c. Method to remove interfering objects by the fuel debris retrieval devices commonly designed for both the access methods

(i) Method and procedure to cut and remove interfering objects in the pedestal

A photo of the simulated mock-up (RPV bottom and fallen object) used for the cutting and removal test of interfering objects in the pedestal is shown below.

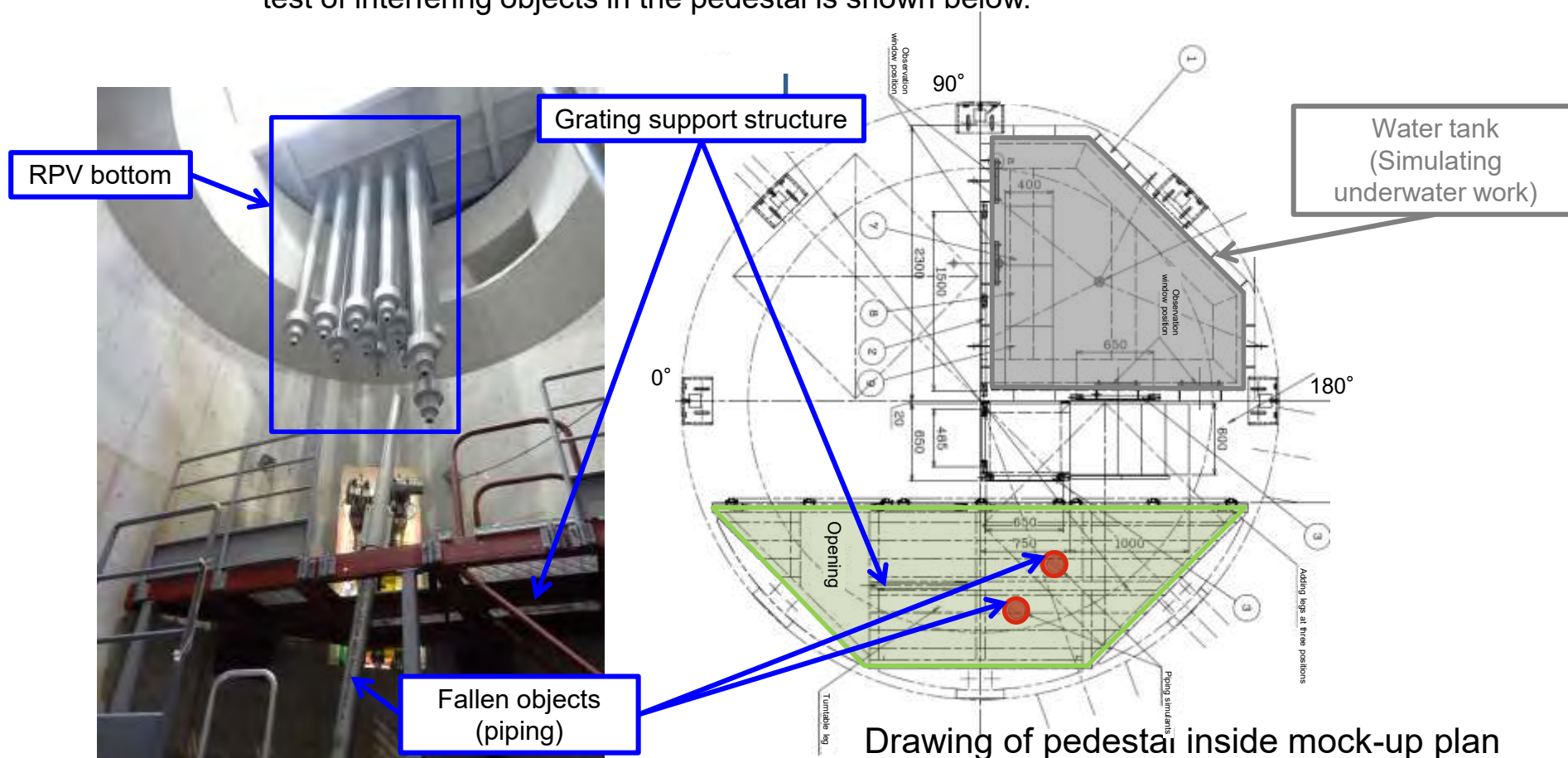

6. Implementation details of this project

6.2. Implementation details

2) Development of Element Technology for Retrieval Device Installation

(2) Development of Interference Object Removal during Fuel Debris Retrieval

c. Method to remove interfering objects by the fuel debris retrieval devices commonly designed for both the access methods

(i) Method and procedure to cut and remove interfering objects in the pedestal

The external appearance of the equipment transfer system used for the test and its main specifications are shown below.



External appearance of the equipment transfer system

Main specifications of the equipment transfer system

Item	Specifications	Notes
Device dimensions	L1725×W1500×H1695mm	
Device weight	550kg	
Loading capacity	400kg	
Travel speed	Approx. 0.02 m/s	When traveling on the floor

6. Implementation details of this project

6.2. Implementation details

2) Development of Element Technology for Retrieval Device Installation

(2) Development of Interference Object Removal during Fuel Debris Retrieval

c. Method to remove interfering objects by the fuel debris retrieval devices commonly designed for both the access methods

(i) Method and procedure to cut and remove interfering objects in the pedestal

The external appearance of the transfer carriage used for the test and its main specifications are shown below.

Same as those used in tests for operation outside the pedestal



External appearance of the transfer carriage

Main specifications of the transfer carriage

Item	Specifications	Notes
Device dimensions	L750×W640×H230mm	
Device weight	50kg	
Loading capacity of the carriage	200kg	
Travel speed of the carriage	50mm/s	When traveling on the floor

6. Implementation details of this project

6.2. Implementation details

2) Development of Element Technology for Retrieval Device Installation

(2) Development of Interference Object Removal during Fuel Debris Retrieval

c. Method to remove interfering objects by the fuel debris retrieval devices commonly designed for both the access methods

(i) Method and procedure to cut and remove interfering objects in the pedestal

The external appearance of the base section of the interfering object removal device used for the test and its main specifications are shown below.

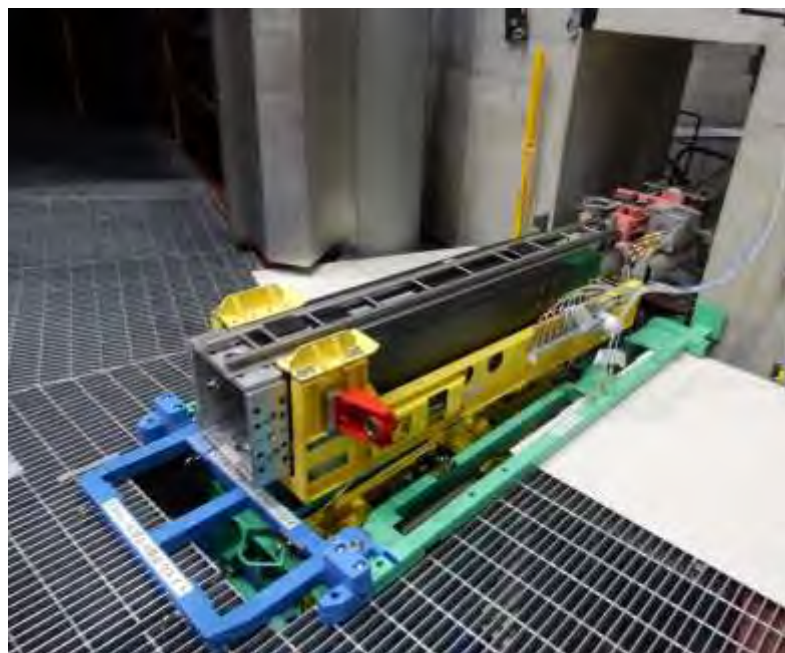

External appearance of the base section of the interfering object removal device

Main specifications of the base section of the interfering object removal device

Item	Specifications	Notes
Device dimensions	L3005×W1100×H897mm	Without booms
Device weight	550kg	Without booms
Operation range	Linear motion: Max. 1,400 mm Pan angle: ±15° Tilt angle: ±15°	Max. 4 booms can be connected.
Cutting tool	Sabre saw (Reciprocating saw)	

6. Implementation details of this project

6.2. Implementation details

2) Development of Element Technology for Retrieval Device Installation

(2) Development of Interference Object Removal during Fuel Debris Retrieval

c. Method to remove interfering objects by the fuel debris retrieval devices commonly designed for both the access methods

(i) Method and procedure to cut and remove interfering objects in the pedestal

The external appearance of the arm section of the interfering object removal device used for the test and its main specifications are shown below.



External appearance of the arm section of the interfering object removal device

Main specifications of the arm section of the interfering object removal device

Item	Specifications	Notes
Device dimensions	L1500×W359×H545mm	
Device weight	120kg	
Loading capacity	20kg	

6. Implementation details of this project

6.2. Implementation details



2) Development of Element Technology for Retrieval Device Installation

(2) Development of Interference Object Removal during Fuel Debris Retrieval

c. Method to remove interfering objects by the fuel debris retrieval devices commonly designed for both the access methods

(i) Method and procedure to cut and remove interfering objects in the pedestal

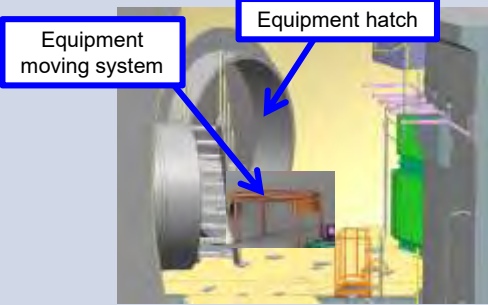
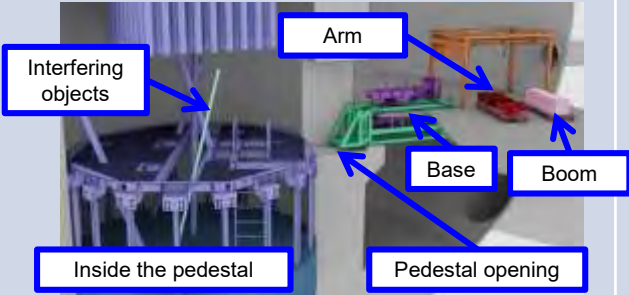
Operation time was measured during the element tests and used to analyze throughput. Illustrations and photos of the device test operation are included in the work step description tables.

Work step	A. Transporting the interfering object removal device into the PCV	B. Moving the interfering object removal device to the pedestal opening	C. Assembling the interfering object removal device (Repeating positioning and installation)
Illustrations/ photos of operation	 <p>Equipment moving system</p> <p>Equipment hatch</p>	 <p>Interfering objects</p> <p>Arm</p> <p>Base</p> <p>Boom</p> <p>Inside the pedestal</p> <p>Pedestal opening</p>	
Operation time	-	For component transportation: approx. 1 hour/trip (started from near the pedestal opening)	For device assembly and installation: 12 h (until the completion of the base section and the connection of two booms)

6. Implementation details of this project

6.2. Implementation details

2) Development of Element Technology for Retrieval Device Installation



(2) Development of Interference Object Removal during Fuel Debris Retrieval

c. Method to remove interfering objects by the fuel debris retrieval devices commonly designed for both the access methods

(i) Method and procedure to cut and remove interfering objects in the pedestal

Operation time was measured during the element tests and used to analyze throughput.

Illustrations and photos of the device test operation are included in the work step description tables.

Work step	D. Investigating conditions in the pedestal	E. Manipulating the arms of the device to interfering objects near the pedestal opening	F. Cutting and removing interfering objects near the pedestal opening (atmospheric and underwater work)
Illustrations/ photos of operation			
Operation time	-	For arms manipulation to target objects: approx. 0.5 hour/object	For interfering object cutting: approx. 0.2 hours/object (SUS pipe with ϕ 114mm diameter and 6mm thickness)

6. Implementation details of this project

6.2. Implementation details



2) Development of Element Technology for Retrieval Device Installation

(2) Development of Interference Object Removal during Fuel Debris Retrieval

c. Method to remove interfering objects by the fuel debris retrieval devices commonly designed for both the access methods

(i) Method and procedure to cut and remove interfering objects in the pedestal

Operation time was measured during the element tests and used to analyze throughput. Illustrations and photos of the device test operation are included in the work step description tables.

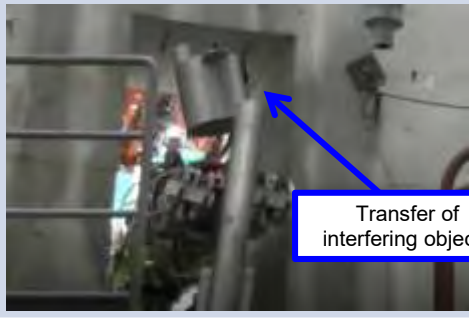
Work step	G. Preparing an interfering objects collection container	H. Storing interfering objects in the collection container	I. Transporting the collection container outside the pedestal
Illustrations/ photos of operation			
Operation time	For setting the collection container in position: approx. 0.2 hour/operation	For cut pieces collection: approx. 0.2 hour/operation	For transporting the container to the outside of the pedestal: approx. 0.2 hour/operation

6. Implementation details of this project

6.2. Implementation details

2) Development of Element Technology for Retrieval Device Installation



(2) Development of Interference Object Removal during Fuel Debris Retrieval

c. Method to remove interfering objects by the fuel debris retrieval devices commonly designed for both the access methods

(i) Method and procedure to cut and remove interfering objects in the pedestal

Operation time was measured during the element tests and used to analyze throughput.

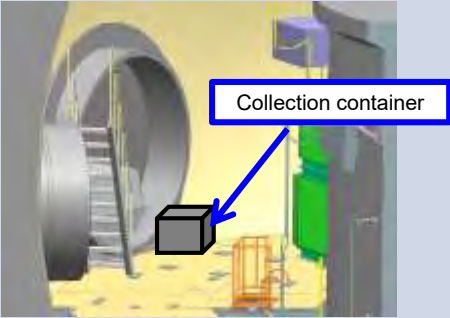
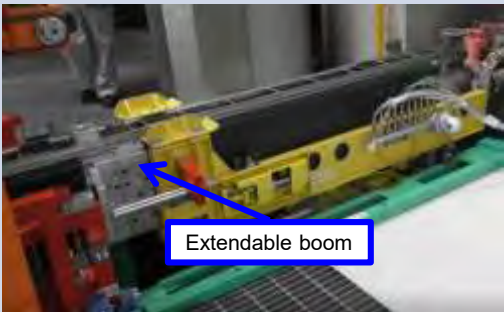
Illustrations and photos of the device test operation are included in the work step description tables.

Work step	J. Transporting the collection container outside the PCV	K. Extending the boom of the interfering object removal device	L. Removing interfering objects farthest from the opening (Repeat steps E and F)
Illustrations/ photos of operation	 <p>Collection container</p>	 <p>Extendable boom</p>	 <p>Interfering object in the middle layer</p>
Operation time	-	For extending the boom: approx. 2 hours/operation	<ul style="list-style-type: none"> For cutting device positioning: approx. 1 hour/object For interfering object cutting: approx. 2 min/object (SS pipe with $\phi 48.6\text{mm}$ diameter and 1.6mm thickness)

6. Implementation details of this project

6.2. Implementation details

2) Development of Element Technology for Retrieval Device Installation

(2) Development of Interference Object Removal during Fuel Debris Retrieval

c. Method to remove interfering objects by the fuel debris retrieval devices commonly designed for both the access methods

(i) Method and procedure to cut and remove interfering objects in the pedestal

Operation time was measured during the element tests and used to analyze throughput.

Estimated operation time is shown below.

No.	Test item	Test procedure	Operation time per cycle	Total operation time	Notes
1	Preparation of the interfering object removal device (Steps B and C)	Transport equipment into the PCV and assemble the interfering object removal device.	-	Total operation time: approx. 19 hours	Total operation time for the transportation of 7 units of equipment, device installation, and assembly
2	Interfering object removal (atmospheric) (Steps D to F)	Cut target interfering objects and collect them in a collection container.	For one cut-and-collect cycle: approx. 0.7 h	The number of cycles needed is four (4) Total operation time: approx. 2.8 hours (Assuming that a 1m-long cylindrical structure is cut into five 0.2m-long pieces)	
3	Interfering object removal (underwater) (Steps D to F)	Cut target interfering objects under water and collect them in a collection container.	For one cut-and-collect cycle: approx. 0.7 h	The number of cycles needed is four (4) Total operation time: approx. 2.8 hours (Assuming that a 1m-long cylindrical structure is cut into five 0.2m-long pieces)	Assumed to be about the same as that of atmospheric operation
4	Transfer of interfering objects (Steps G to I)	Transfer the collection container containing cut pieces of interfering objects to the transportation route.	For the collection container transfer: approx. 2.2 hours/trip	The number of cycles needed is five (5). Total operation time: 11 h	

6. Implementation details of this project

6.2. Implementation details

2) Development of Element Technology for Retrieval Device Installation

(2) Development of Interference Object Removal during Fuel Debris Retrieval

c. Method to remove interfering objects by the fuel debris retrieval device commonly designed for both the access methods

(i) Method and procedure to cut and remove interfering objects in the pedestal

Results of the element tests and main issues identified in each process

No.	Test item	Test results	Main issues	Action policy*
1	Preparation of the interfering object removal device	All components were transported into the PCV, and the interfering object removal device was installed and assembled.	Shortening of time to place components at planned positions	Development of a manipulation support function applicable to the component moving system
			Transportation of the components from the entrance of the equipment hatch to the installation location	Detailed design of the components carrying in/ out method (*)
			Development of remote control methods applicable to the components connecting work	Development of the joint mechanism and method easy to connect remotely
2	Interfering object removal	Interfering object simulants placed in a narrow place near the pedestal opening were cut and removed.	Shortening of time to locate cutting tools at desired cutting positions	Development of a cutting tool locating supporting function
			Expansion of interfering object cutting devices covering range	Detailed design of interfering object transportation routes
			Method to monitor operation in areas distant from the openings	Development of a method to provide an external point of view in combination with images from installed cameras
3	Transfer of interfering objects	Cut pieces of interfering objects were collected in collection containers and transported outside the pedestal.	Interface mechanism between the collection container and the transport container and remote connection/disconnection method	Development of the interface mechanism and method easy to connect and disconnect remotely
			Shortening of time to put cut pieces in collection containers	Shortening of time to locate cutting tools and collection containers at desired positions
			Shortening of collection container carrying in/out time	Streamlining of collection container carrying in/out method (*)
4	Remote operation and monitoring test	The layout of cameras required to realize the remote operation of each step was examined.	Remote operation monitoring	Detailed design of a method to install monitoring equipment remotely (*)
			Expansion of areas covered by remote operation	Introduction of remote operation for the installation and construction of operation devices and peripheral equipment (*)

Actions with an asterisk () will be set out in the following fiscal year onward. Others will be worked on through future engineering activities.

6. Implementation details of this project

6.2. Implementation details

2) Development of Element Technology for Retrieval Device Installation

(2) Development of Interference Object Removal during Fuel Debris Retrieval

c. Method to remove interfering objects by the fuel debris retrieval device commonly designed for both the access methods

(ii) Evaluation of the operational performance of the robot arm and access rail combined system

● Issues

- Although the independent functions of the robot arm and access rail were demonstrated in the element tests in FY2015 and FY2016, a series of operations of the robot arm and access rail combined system has not been tested yet.

It is essential to verify the feasibility and performance of the integrated system and identify issues associated with it through combination tests, since the feasibility of the transportation of these devices from the cell into the pedestal and the feasibility of fuel debris opening operation in the pedestal, using them are keys for the success of methods development, not to mention its significant impact on other facilities such as the cells.

● Results of the tests in FY2015 and FY2016

- The components were built and the following unit tests were performed. The feasibility of functions required for the components alone and the design adequacy of them were demonstrated.

Robot arm test

- 1) The availability of emergency withdrawal methods was demonstrated.
- 2) Positioning accuracy was evaluated.
- 3) Strength was evaluated.

Access rail test

- 1) The applicability of remote control was demonstrated.
- 2) Strength was evaluated.



6. Implementation details of this project

6.2. Implementation details

2) Development of Element Technology for Retrieval Device Installation

(2) Development of Interference Object Removal during Fuel Debris Retrieval

c. Method to remove interfering objects by the fuel debris retrieval device commonly designed for both the access methods

(ii) Evaluation of the operational performance of the robot arm and access rail combined system

- Technologies to be developed

Technological challenge: Development of a method to guide the arm transfer carriage to the front end of the access rail (extendable boom) without causing problems at the joints of the access rail

Issue 1: Method to guide the vehicle through the joints of the access rail without problems
(Adjusting the track width according to the rail width)

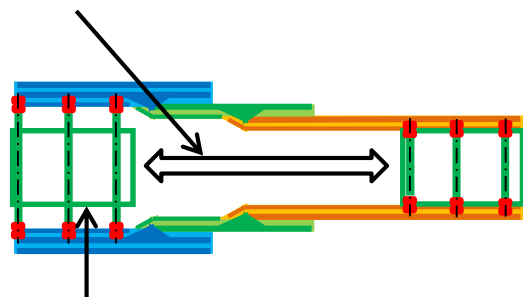

Issue 2: Method to keep the vehicle in the center
(Keep the vehicle in the center of the rail while adjusting the track width)

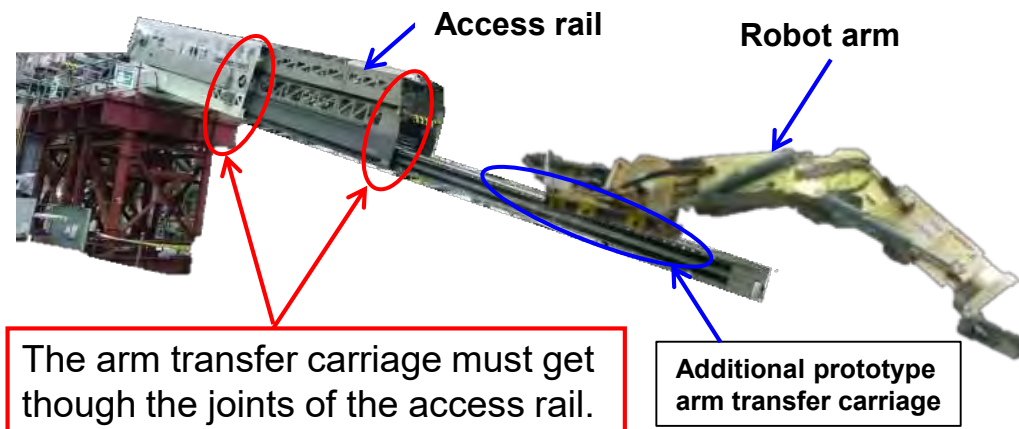

In order to solve the above-mentioned issues, the structure of the arm transfer carriage will be designed, prototyped and tested, and the feasibility of the structure will be verified.

6. Implementation details of this project

6.2. Implementation details

2) Development of Element Technology for Retrieval Device Installation

(2) Development of Interference Object Removal during Fuel Debris Retrieval

c. Method to remove interfering objects by the fuel debris retrieval device commonly designed for both the access methods

(ii) Evaluation of the operational performance of the robot arm and access rail combined system

- Purpose of development
 - Perform the operation test of the robot arm and access rail combined system to evaluate the feasibility of basic operation patterns required for interfering object and fuel debris removal, as well as the feasibility of remote control of all devices and equipment involved in the operation.

- Approaches to development
 - Conceptual study of interfering object and fuel debris removal methods
 - ✓ Development of the arms of the interfering object removal device that can meet operational requirements
 - ✓ Development of a method to guide the arms into the pedestal
 - Element test plan
 - ✓ Study of test methods and test items
 - ✓ Consideration of the use of existing devices and equipment (developed in FY2015 and FY2016), development of new devices and equipment
 - Preparation for tests and element tests
 - ✓ Test device fabrication
 - ✓ Testing system construction
 - ✓ Element test

6. Implementation details of this project

6.2. Implementation details

2) Development of Element Technology for Retrieval Device Installation

(2) Development of Interference Object Removal during Fuel Debris Retrieval

c. Method to remove interfering objects by the fuel debris retrieval device commonly designed for both the access methods

(ii) Evaluation of the operational performance of the robot arm and access rail combined system

● Development objectives

Item	Evaluation criteria/targets	Notes
Feasibility of the entire operation process	The entire operation process from guiding the arms and access rail into the pedestal, opening and removing fuel debris, to collecting it shall be able to be performed remotely.	<ul style="list-style-type: none"> Method to guide the robot arm into the pedestal (Arm transfer carriage travel on the access rail) Method to fix robot arms to the rail Method to transport the unit can to the cell (Collection by the can transfer carriage) * Fuel debris opening work is not included. (Operation to collect the cut pieces of fuel debris is to be simulated.)
Feasibility of emergency withdrawal methods that take into consideration possible failures	The robot arm and access rail shall be able to be withdrawn to the inside of the cell in case the drive of them is lost.	<ul style="list-style-type: none"> Method to withdraw robot arms to the cell (Withdrawal by the arm transfer carriage) Method to extend and contract the access rail Method to tilt the access rail back to horizontal position
Remote operation performance of the entire process based on camera images	The control of the access rail extension and the positioning of the robot arm tip to targets shall be able to be performed remotely, by the help of images from cameras mounted on the device.	<ul style="list-style-type: none"> Method to guide the access rail through the pedestal opening Method to manipulate the robot arm tip to targets
Measurement of the operation time of each work step for throughput estimation	The operation time of each work step shall be equal to or shorter than expected time.	

6. Implementation details of this project

6.2. Implementation details

2) Development of Element Technology for Retrieval Device Installation

(2) Development of Interference Object Removal during Fuel Debris Retrieval

c. Method to remove interfering objects by the fuel debris retrieval device commonly designed for both the access methods

(ii) Evaluation of the operational performance of the robot arm and access rail combined system

● Expected outcome

- Feasibility of the entire operation process from guiding the device into the pedestal, opening and removing fuel debris, to collecting it

A method and route to transport various devices and collection cans between the cell and the inside of the pedestal will be established by the verification of the feasibility of the entire operation process, including the functions of the transfer carriages and emergency withdrawal methods.

In addition, the total operation time for the transportation of devices and cans between the cell and the inside of the pedestal is measured so as to be more accurate than that estimated through desk engineering work. Accordingly, throughput can be estimated more accurately.

- Remote operation performance of the entire process from guiding the device into the pedestal, opening and removing fuel debris, to collecting it based on camera images
The number of cameras and their layout required to enable stable remote control of the entire process will be made clear by evaluating remote operation performance based on currently planned number and layout of cameras and reconsidering the number and layout according to the result.
- Identification of specific issues and measures to address them
Unexpected issues will be identified through tests, and measures to address the identified issues will be developed. Outcomes of those activities will be reflected in the R&D project plan for next fiscal year and beyond effectively.

6. Implementation details of this project

6.2. Implementation details

2) Development of Element Technology for Retrieval Device Installation

(2) Development of Interference Object Removal during Fuel Debris Retrieval

c. Method to remove interfering objects by the fuel debris retrieval device commonly designed for both the access methods

(ii) Evaluation of the operational performance of the robot arm and access rail combined system

● Purposes of tests (Test items)

Legend:
 ✓ : Tested
 - : Not tested

Phase	Purposes of tests (Test items)	FY2015 and FY2016 Element test (Unit tests)	FY2017 and FY2018 Element test (Combination tests)	Notes
1) Operation to guide robot arms and access rail into the pedestal				
Installation of the robot arm on the access rail	Robot arms shall be able to be installed on the access rail.	—	○	
Remote extension of the access rail	The access rail shall be able to be extended through the full-scale mock-up of the pedestal opening remotely, with the help of images from cameras mounted on the device.	○	✓*1	
Guiding the robot arm into the pedestal	Robot arms shall be able to be guided into the pedestal by the access rail.	—	○	
2) Operation of interfering object cutting/fuel debris opening and collection				
Interfering object cutting/fuel debris opening and collection	Robot arms shall be able to be manipulated to interfering objects/fuel debris to cut or bore them.	○	✓*1	
	The structure of the robot arm and access rail shall be strong and rigid enough to handle reaction force caused by interfering object cutting/fuel debris opening work.	○	✓*2	
Transportation of the unit can to the cell (Travel of the can transfer carriage in the access rail)	The unit can shall be able to be transported by the can transfer carriage of the access rail.	—	○	

*1: Tested in dark conditions, using images from installed cameras; *2: The impact of reaction force was evaluated using the arm and access rail combined system.

6. Implementation details of this project

6.2. Implementation details

2) Development of Element Technology for Retrieval Device Installation

(2) Development of Interference Object Removal during Fuel Debris Retrieval

c. Method to remove interfering objects by the fuel debris retrieval device commonly designed for both the access methods

(ii) Evaluation of the operational performance of the robot arm and access rail combined system

● Purposes of tests (Test items)

Legend:
 ✓: Tested
 -: Not tested

Phase	Purposes of tests (Test items)	FY2015 and FY2016 Element test (Unit tests)	FY2017 and FY2018 Element test (Combination tests)	Notes
3) Robot arm/access rail failure recovery operation				
Emergency withdrawal	The robot arm and access rail shall be able to be withdrawn in case of their failure.	—	○	
4) Others related to the entire process				
Operation process from the installation of the access device, cutting/opening of interfering objects/fuel debris and collection of them, to the uninstallation of the access device	The entire operation process from the installation of the access device, cutting/opening of interfering objects/fuel debris and collection of them, to the uninstallation of the access device shall be able to be performed by remote control.	—	○	
	Measurement of the operation time of each work step for throughput estimation.	—	○	

6. Implementation details of this project

6.2. Implementation details

2) Development of Element Technology for Retrieval Device Installation

(2) Development of Interference Object Removal during Fuel Debris Retrieval

c. Method to remove interfering objects by the fuel debris retrieval device commonly designed for both the access methods

(ii) Evaluation of the operational performance of the robot arm and access rail combined system

● Conceptual study

- A hydraulic robot arm with a reaction force of two (2) tons and access rail were examined to develop a method to bore fuel debris deposited at the bottom of the pedestal in the conceptual study in the fiscal year two years ago.
- Meanwhile, electrically powered robot arms, which have a wider range of movement than hydraulic ones, were examined for the cutting and removal of interfering objects such as the grating, since handling such objects was thought to require less load capacity of the arms.
- Nonetheless, tests to evaluate the manipulation performance of the arm and access rail combined systems and the feasibility of the entire operation process with the use of said systems will be planned for both the robot arm types, since robot arms need to be guided into the pedestal regardless of their types.

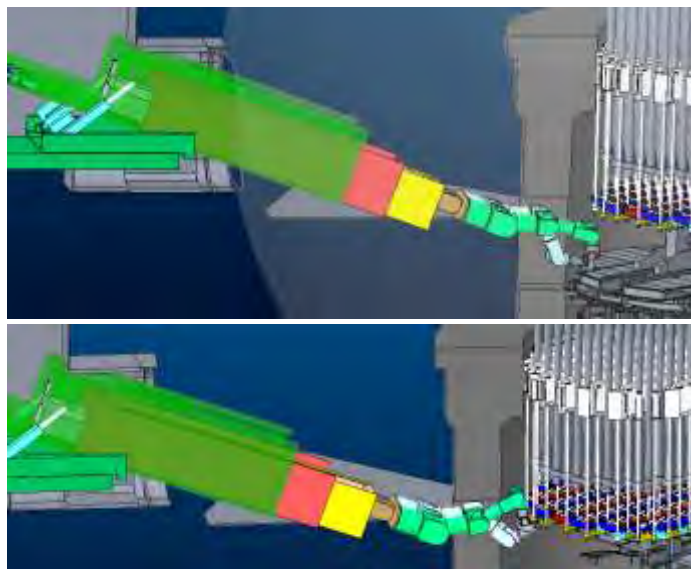

Interfering objects removal by electrically powered arms



Fuel debris removal by a hydraulic robot arm

6. Implementation details of this project

6.2. Implementation details





2) Development of Element Technology for Retrieval Device Installation

(2) Development of Interference Object Removal during Fuel Debris Retrieval

c. Method to remove interfering objects by the fuel debris retrieval device commonly designed for both the access methods

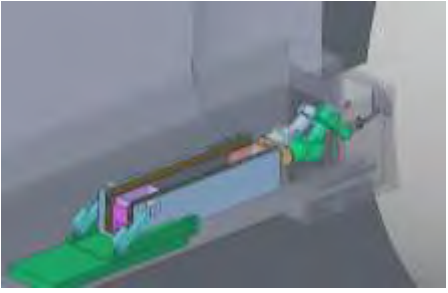
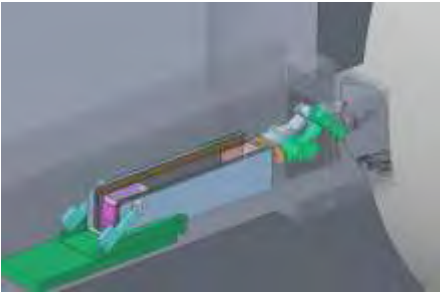
(ii) Evaluation of the operational performance of the robot arm and access rail combined system

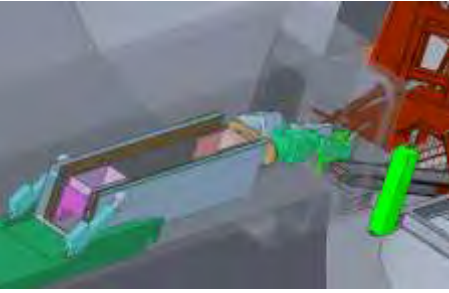
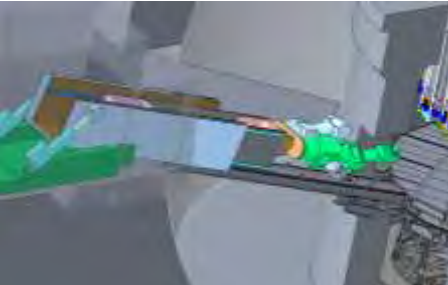
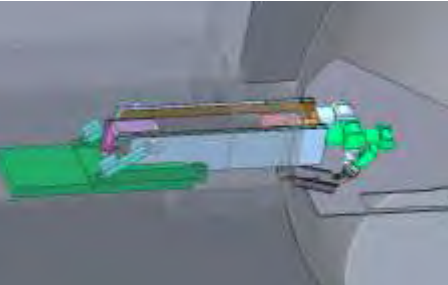
[Illustration of the work steps of interfering object removal operation]

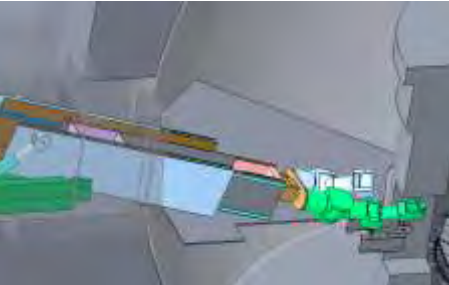
1. Cutting the PCV wall	2. Cutting the PCV wall (Keep the CRD rail connecting section left.)	3. Cutting pipes	4. Cutting out a part above the X-6 penetration of the grating in the PCV
			
5. Cutting CRD rails in far-end areas first	6. Cutting CRD rails in near-end areas next	7. Cutting the remaining part of the X-6 penetration	8. Cutting out a part around the CRD rails of the grating
			

6. Implementation details of this project

6.2. Implementation details

2) Development of Element Technology for Retrieval Device Installation

(2) Development of Interference Object Removal during Fuel Debris Retrieval

c. Method to remove interfering objects by the fuel debris retrieval device commonly designed for both the access methods

(ii) Evaluation of the operational performance of the robot arm and access rail combined system

[Illustration of the work steps of interfering object removal operation]

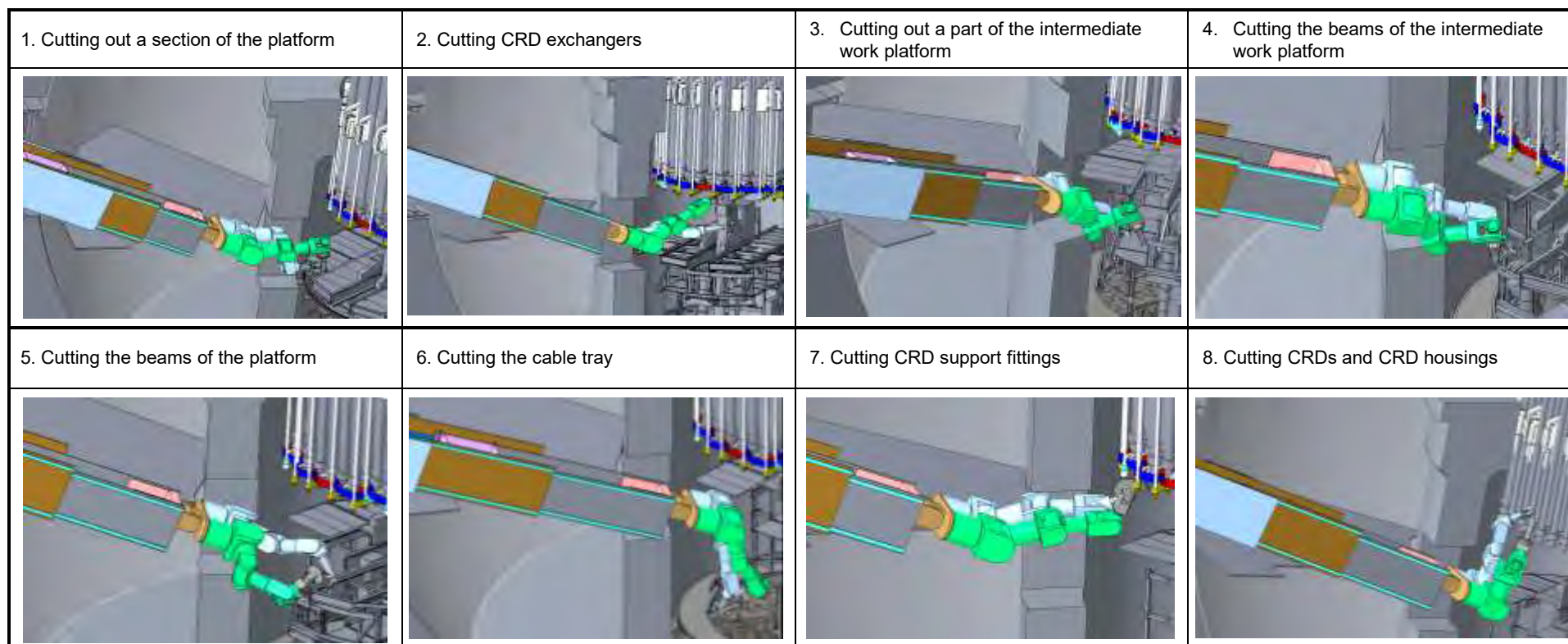

6. Implementation details of this project

6.2. Implementation details

2) Development of Element Technology for Retrieval Device Installation

(2) Development of Interference Object Removal during Fuel Debris Retrieval

c. Method to remove interfering objects by the fuel debris retrieval device commonly designed for both the access methods

(ii) Evaluation of the operational performance of the robot arm and access rail combined system

● Approach to elemental tests

- In a conceptual study, an electrically powered robot arm is studied for interfering object removal, and a hydraulic robot arm for fuel debris removal.
- Both the arms need to be guided into the pedestal by the access rail.
- Though the method to drive the arm is different between interfering object removal and fuel debris removal, individual work steps of the entire operation process are almost the same for both of them.
- Results of arm guiding tests with a hydraulic robot arm are considered to be applicable to an electrically powered robot arm since the former has larger dimensions and weight.



Tests to evaluate the manipulation performance of a robot arm and access rail combined system are planned with the hydraulic robot arm developed and built in the fiscal year two years ago.

● Identification of evaluation items

- Evaluation items were considered focusing on the work steps of fuel debris removal since the work steps of the entire operation process are almost the same for interfering object removal and fuel debris removal.
- The identified evaluation items were grouped into those evaluated by conceptual study and those evaluated through element tests based on the following aspects:
 - ✓ Whether the item needs to be evaluated through verification tests at a high priority in order to know the feasibility of the method promptly?
(Evaluation of items whose test results have an impact on the design of the method and process)
 - ✓ Whether it is sufficient to evaluate the feasibility of the item through a step-by-step process along with other items?

6. Implementation details of this project

6.2. Implementation details

2) Development of Element Technology for Retrieval Device Installation

(2) Development of Interference Object Removal during Fuel Debris Retrieval

c. Method to remove interfering objects by the fuel debris retrieval device commonly designed for both the access methods

(ii) Evaluation of the operational performance of the robot arm and access rail combined system

- Work steps and evaluation items

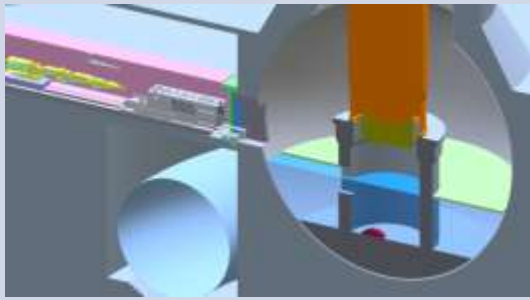
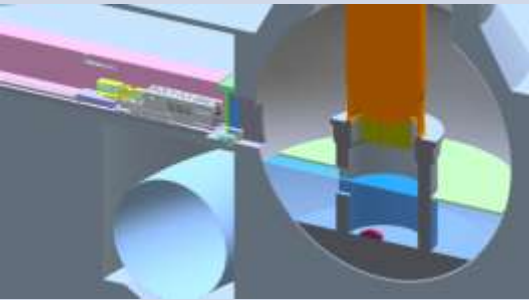
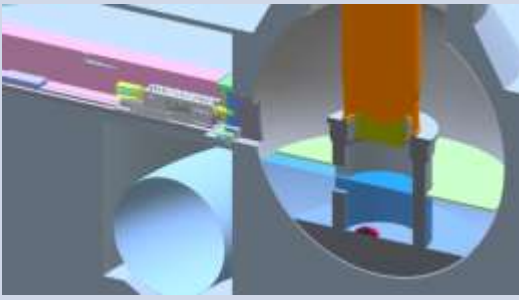
Work step	1. Transporting the robot arm into the cell	2. Guiding the robot arm and arm transfer carriage into the access rail	3. Setting the robot arm and arm transfer carriage on the access rail
Illustration of each step			
Verification item	<ul style="list-style-type: none"> (1) Travel of the device along the pathway between the cells <ul style="list-style-type: none"> 1) Method to get through gaps and off-center errors in the pathway without problems 2) Accuracy of stop position 3) Prevention of the inclination of the carrying vehicle (2) Utility supply during travel between the cells <ul style="list-style-type: none"> 1) Method to deal with shutters in the pathway 2) Method to run cables 	<ul style="list-style-type: none"> (1) Method to transfer the arm transfer carriage from the pathway to the access rail (2) Coupling of the arm transfer carriage to the can transfer carriage <ul style="list-style-type: none"> 1) Coupling position detection 2) Positioning by the can transfer carriage 3) Retention of coupling in case of drive power loss 	Same as on the left

6. Implementation details of this project

6.2. Implementation details

2) Development of Element Technology for Retrieval Device Installation

(2) Development of Interference Object Removal during Fuel Debris Retrieval

c. Method to remove interfering objects by the fuel debris retrieval device commonly designed for both the access methods

(ii) Evaluation of the operational performance of the robot arm and access rail combined system

- Work steps and evaluation items

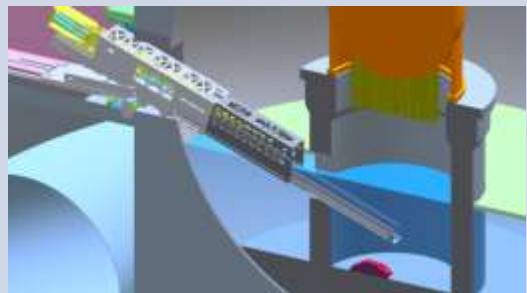
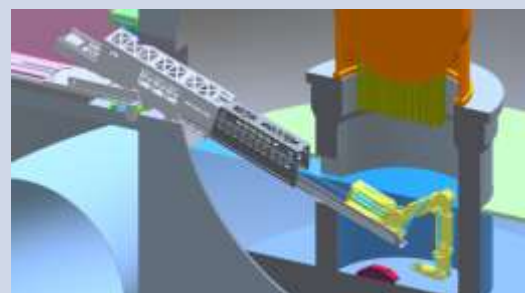
Work step	4. Tilting the access rail toward the opening for CRD exchange work	5. Extending the access rail	6. Moving the robot arm forward and unfolding it
Illustration of each step			
Verification item	(1) Tilting the access rail <ol style="list-style-type: none"> 1) Speed 2) Range of movement 3) Cable handling 4) Accuracy of stop position 5) Vibration Element tests were done for the above items in the fiscal year two years ago	(1) Extending and contracting the access rail <ol style="list-style-type: none"> 1) Speed 2) Range of movement 3) Cable handling 4) Accuracy of stop position 5) Vibration (2) Remote extension of the access rail (Feasibility of the access rail length control guided by camera images) Element tests were done for the above items in the fiscal year two years ago (Note that the feasibility of the access rail length control in dark conditions guided by camera images was not tested.)	(1) Driving the arm transfer carriage <ol style="list-style-type: none"> 1) Speed 2) Range of movement 3) Cable handling 4) Accuracy of stop position 5) Vibration 6) Ability of the arm transfer carriage to get through the joins of the access rail without problems (2) Robot arm remote manipulation to targets (3) Method to fix the arm transfer carriage to the access rail <ol style="list-style-type: none"> 1) Fixation strength 2) Retention of fixation strength in case of drive power loss

6. Implementation details of this project

6.2. Implementation details

2) Development of Element Technology for Retrieval Device Installation

(2) Development of Interference Object Removal during Fuel Debris Retrieval

c. Method to remove interfering objects by the fuel debris retrieval device commonly designed for both the access methods

(ii) Evaluation of the operational performance of the robot arm and access rail combined system

- Work steps and evaluation items

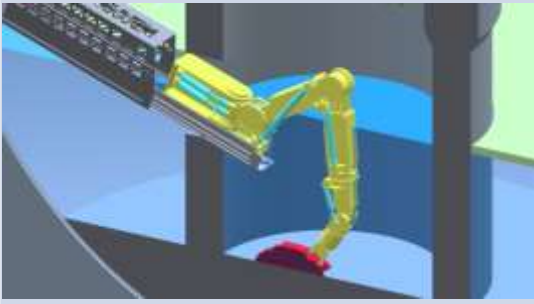
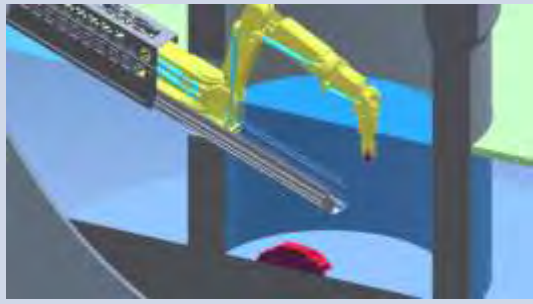
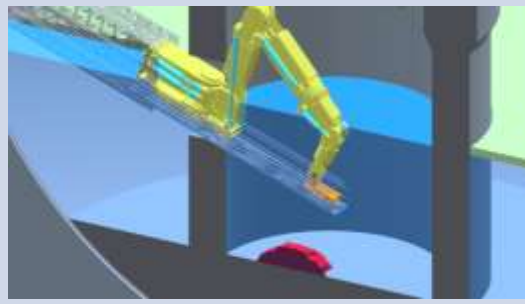
Work step	7. Manipulating the robot arm to fuel debris	8. Drilling fuel debris by a opening tool mounted on the robot arm	9. Collecting fuel debris dug out from the fuel debris bed in the unit can on the can transfer carriage on the access rail
Illustration of each step			
Verification item	<ul style="list-style-type: none"> (1) Manipulation of the robot arm to target interfering objects and fuel debris (2) Robot arm tip positioning accuracy <p>Element tests were done for the above items in the fiscal year two years ago</p>	<ul style="list-style-type: none"> (1) Interfering objects removal operation procedures (2) Interfering objects removal method (3) Fuel debris opening method (4) Collection of cutting chips generated by interfering object cutting and fuel debris opening (5) Withstanding the reaction force of the opening tool opening fuel debris 	<ul style="list-style-type: none"> (1) Interfering object/fuel debris grabbing method (2) Method to determine the size that fits into the unit can

6. Implementation details of this project

6.2. Implementation details

2) Development of Element Technology for Retrieval Device Installation

(2) Development of Interference Object Removal during Fuel Debris Retrieval

c. Method to remove interfering objects by the fuel debris retrieval device commonly designed for both the access methods

(ii) Evaluation of the operational performance of the robot arm and access rail combined system

- Work steps and evaluation items

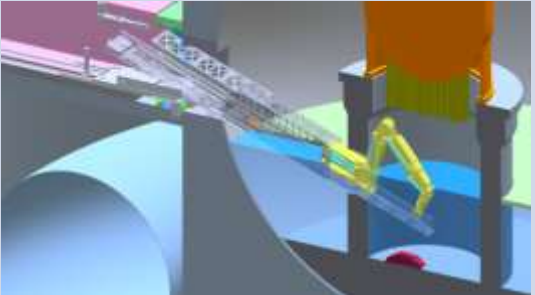
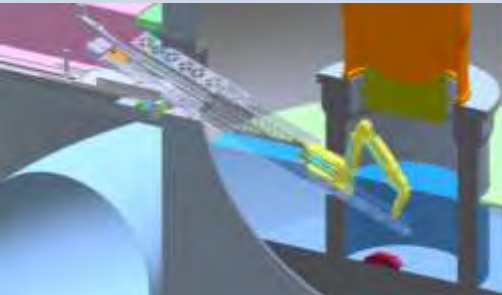
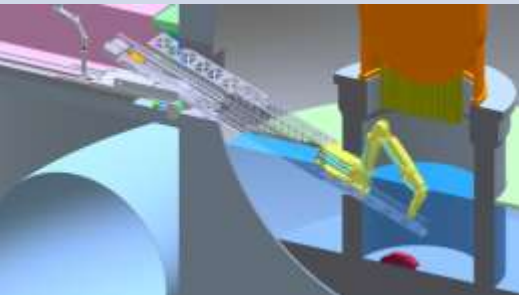
Work step	10. Transporting the unit can to the cell by the can transfer carriage on the access rail	11. Picking up the unit can by the manipulator in the cell	12. Storing the fuel debris-containing unit can in the storage canister by the manipulator in the cell
Illustration of each step			
Verification item	(1) Travel of the can transfer carriage <ol style="list-style-type: none"> 1) Descent by the self-weight 2) Speed 3) Range of movement 4) Accuracy of stop position 5) Vibration 6) Ability of the arm transfer carriage to get through the joins of the access rail without problems 	(1) Unit can grabbing method (Shape of the unit can)	(1) Method to pack the unit can in the storage canister <ol style="list-style-type: none"> (2) Design of the storage canister <ol style="list-style-type: none"> 1) Lid sealing 2) Drying 3) Degassing

6. Implementation details of this project

6.2. Implementation details

2) Development of Element Technology for Retrieval Device Installation

(2) Development of Interference Object Removal during Fuel Debris Retrieval

c. Method to remove interfering objects by the fuel debris retrieval device commonly designed for both the access methods

(ii) Evaluation of the operational performance of the robot arm and access rail combined system

- Work steps and evaluation items

Work step	Others
Illustration of each step	-
Verification item	<ul style="list-style-type: none"> (1) Emergency withdrawal <ul style="list-style-type: none"> 1) Folding the robot arm for withdrawal. Element tests were done for this operation in the fiscal year two years ago. 2) Withdrawal of the robot arm to the cell (Reverse travel of the arm transfer carriage) 3) Contraction of the access rail 4) Tilting the access rail back to horizontal position 5) Withdrawal of the access rail to the cell (2) Resistance to environment (radiation, temperature, humidity, dust, foreign objects) (3) Maintainability (camera replacement) (4) End tool replacement (5) Feasibility of the entire operation process (6) Throughput

6. Implementation details of this project

6.2. Implementation details

2) Development of Element Technology for Retrieval Device Installation

(2) Development of Interference Object Removal during Fuel Debris Retrieval

c. Method to remove interfering objects by the fuel debris retrieval device commonly designed for both the access methods

(ii) Evaluation of the operational performance of the robot arm and access rail combined system

● Verification items and verification methods

No.	Main issues	Verification item	Verification methods		Notes
			Conceptual study	Element test	
1	Transfer of the device between the cells	(1) Transfer of the device between the cells 1) Method to get through gaps and off-center errors in the pathway without problems 2) Accuracy of stop position 3) Prevention of the inclination of the carrying vehicle (2) Utility supply during travel between the cells 1) Method to deal with shutters in the pathway 2) Method to run cables	○ (There are proven records with mobile cranes.)	-	Further actions will be determined according the result of the conceptual study
2	Installation of the robot arm on the access rail (The center of gravity of the robot arm is located outside the wheelbase and wheel track.)	(1) Method to transfer the arm transfer carriage from the pathway to the access rail (2) Coupling of the arm transfer carriage to the can transfer carriage 1) Coupling position detection 2) Positioning by the can transfer carriage 3) Retention of coupling in case of drive power loss	○ for item (1) in the left column	○ for item (2) in the left column	For item (1), further actions will be determined according the result of the conceptual study

6. Implementation details of this project

6.2. Implementation details

2) Development of Element Technology for Retrieval Device Installation

(2) Development of Interference Object Removal during Fuel Debris Retrieval

c. Method to remove interfering objects by the fuel debris retrieval device commonly designed for both the access methods

(ii) Evaluation of the operational performance of the robot arm and access rail combined system

● Verification items and verification methods

No.	Main issues	Verification item	Verification methods		Notes
			Conceptual study	Element test	
3	Remote extension of the access rail · Tilting · Extension and contraction · Fixation to the pedestal · Positioning guided by camera images	(1) Remote extension of the access rail 1) Speed 2) Range of movement 3) Cable handling 4) Accuracy of stop position 5) Vibration (2) Feasibility of the access rail length control guided by camera images	-	○ · Already done in the fiscal year two years ago · Tests in dark conditions are planned in this fiscal year.	
4	Guiding the robot arm into the pedestal (Ability of the transfer carriages to get through the joints of the access rail without problems)	(1) Travel of the transfer carriages in the access rail 1) Speed 2) Range of movement 3) Cable handling (for arm transfer carriage) 4) Accuracy of stop position 5) Vibration 6) Ability of the transfer carriages to get through the joints of the access rail without problems (2) Robot arm remote manipulation to targets (Feasibility of the method to locate the robot arm tip guided by camera images) (3) Method to fix the arm transfer carriage to the access rail 1) Fixation strength 2) Retention of fixation strength in case of drive power loss	○ Cable handling: There are proven records with bears and reels.	○ Except cable handling	As to cable handling, further action will be determined according the results of the conceptual study

6. Implementation details of this project

6.2. Implementation details

2) Development of Element Technology for Retrieval Device Installation

(2) Development of Interference Object Removal during Fuel Debris Retrieval

c. Method to remove interfering objects by the fuel debris retrieval device commonly designed for both the access methods

(ii) Evaluation of the operational performance of the robot arm and access rail combined system

● Verification items and verification methods

No.	Main issues	Verification item	Verification methods		Notes
			Conceptual study	Element test	
5	Processing of fuel debris and Interfering object (drilling)	(1) Positioning of the robot arm to fuel debris and interfering objects guided by camera images	-	○ · Already done in the fiscal year two years ago · Tests in dark conditions are planned in this fiscal year.	Manipulation to target objects by relying on images sent from cameras mounted on the device
		(2) Robot arm tip positioning accuracy	-	- · Already done in the fiscal year two years ago	
		(3) Processing of fuel debris and Interfering object (drilling)	○	(○)*	Conceptual study will be performed in reference to the result of the element test.

*: The element test of this work will be performed in the fuel debris opening element test and interfering object removal element test.

6. Implementation details of this project

6.2. Implementation details

2) Development of Element Technology for Retrieval Device Installation

(2) Development of Interference Object Removal during Fuel Debris Retrieval

c. Method to remove interfering objects by the fuel debris retrieval device commonly designed for both the access methods

(ii) Evaluation of the operational performance of the robot arm and access rail combined system

● Verification items and verification methods

No.	Main issues	Verification item	Verification methods		Notes
			Conceptual study	Element test	
5	Processing of fuel debris and Interfering object (drilling)	(4) Collection of cutting chips generated by processing(drilling) interfering object and fuel debris	○	(○)*	Conceptual study will be performed in reference to the result of the element test.
		(5) Withstanding the reaction force during processing(drilling) interfering objects and fuel debris	-	○	Stiffness of the arm-access rail combined system was tested against two (2) tons of downward force applied to it.
6	Collection of the unit can that contains fuel debris dug out from the fuel debris bed	(1) Interfering object/fuel debris grabbing method (2) Method to determine the size that fits into the unit can	○	-	Further actions will be determined according the result of the conceptual study
7	Transportation of the unit can to the cell (Ability of the transfer carriages to get through the joins of the access rail without problems)	(1) Travel of the can transfer carriage in the access rail 1) Descent by the self-weight 2) Speed 3) Range of movement 4) Accuracy of stop position 5) Vibration 6) Ability of the transfer carriages to get through the joins of the access rail without problems	-	○	Verification of the can transfer carriage's functions

*: The element test of this work will be performed in the fuel debris opening element test and interfering object removal element test.

6. Implementation details of this project

6.2. Implementation details

2) Development of Element Technology for Retrieval Device Installation

(2) Development of Interference Object Removal during Fuel Debris Retrieval

c. Method to remove interfering objects by the fuel debris retrieval device commonly designed for both the access methods

(ii) Evaluation of the operational performance of the robot arm and access rail combined system

● Verification items and verification methods

No.	Main issues	Verification item	Verification methods		Notes
			Conceptual study	Element test	
8	Store unit can in canister	(1) Unit can grabbing method (shape of the unit can) (2) Method to pack the unit can in the storage canister	○	-	Further actions will be determined according the result of the conceptual study
		(3) Design of the storage canister 1) Lid sealing 2) Drying 3) Degassing	Designed by the storage canister project team		
9	Emergency withdrawal	(1) Folding the robot arm for withdrawal	-	- · Already done in the fiscal year two years ago	
		(2) Withdrawal of the robot arm to the cell (Reverse travel of the arm transfer carriage) (3) Contraction of the access rail (4) Tilting the access rail back to horizontal position	-	○	Evaluation of the feasibility of the emergency withdrawal method for the robot arm and access rail which is designed to use pulling by a winch in the cell

6. Implementation details of this project

6.2. Implementation details

2) Development of Element Technology for Retrieval Device Installation

(2) Development of Interference Object Removal during Fuel Debris Retrieval

c. Method to remove interfering objects by the fuel debris retrieval device commonly designed for both the access methods

(ii) Evaluation of the operational performance of the robot arm and access rail combined system

● Verification items and verification methods

No.	Main issues	Verification item	Verification methods		Notes
			Conceptual study	Element test	
9	Emergency withdrawal	(5) Withdrawal of the access rail to the cell	○ (Traction by another vehicle is planned tentatively. There are many proven records with a traction vehicle.)	-	Further actions will be determined according the result of the conceptual study
10	Resistance to environment	(1) Resistance to environment (radiation, temperature, humidity, dust, foreign objects)	○	-	Further actions will be determined according the result of the conceptual study
11	Maintainability	(1) Listing of maintenance items (2) Study of maintenance methods	○	-	Further actions will be determined according the result of the conceptual study

6. Implementation details of this project

6.2. Implementation details

2) Development of Element Technology for Retrieval Device Installation

(2) Development of Interference Object Removal during Fuel Debris Retrieval

c. Method to remove interfering objects by the fuel debris retrieval device commonly designed for both the access methods

(ii) Evaluation of the operational performance of the robot arm and access rail combined system

● Verification items and verification methods

No.	Main issues	Verification item	Verification methods		Notes
			Conceptual study	Element test	
12	End tool replacement	(1) Study of tool replacement methods by remote control (2) Study of tool carrying in/out methods	○	-	Further actions will be determined according the result of the conceptual study
13	Feasibility of the entire operation process	(1) Identification of issues through the test of the entire operation process	-	○	The currently planned operation process for fuel debris removal will be tested from start to end to determine whether there are any new issues to be addressed.
14	Throughput	(1) Throughput estimate	-	○	The operation time of each work step will be measured to analyze throughput.

6. Implementation details of this project

6.2. Implementation details

2) Development of Element Technology for Retrieval Device Installation

(2) Development of Interference Object Removal during Fuel Debris Retrieval

c. Method to remove interfering objects by the fuel debris retrieval device commonly designed for both the access methods

(ii) Evaluation of the operational performance of the robot arm and access rail combined system

● Outlines of the testing devices

- [1] Robot arm
(Already built) : 6-axis hydraulic manipulator
Processing reaction force of 2 tons (based on the assumption of using an approx. $\phi 60$ mm coring bit)
Arm length of 7.1 m (base on the assumption that the arm needs to reach 1.5 m below the bottom of the pedestal from the bottom of the RPV)
- [2] Access rail
(Arm transfer carriage was additionally built) : Three-section extendable rail
It is fixed to the cell floor and the pedestal opening for CRD exchange work.
- [3] Testing system
(Newly built) : The cell floor and pedestal opening are simulated.

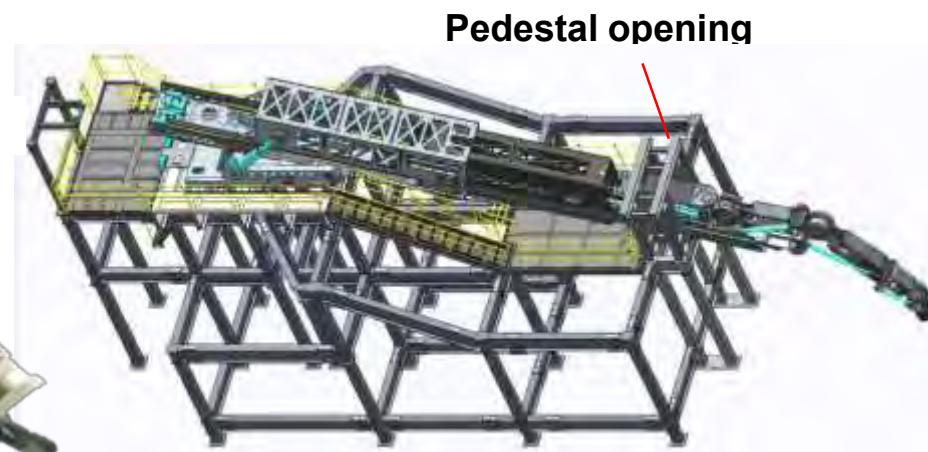
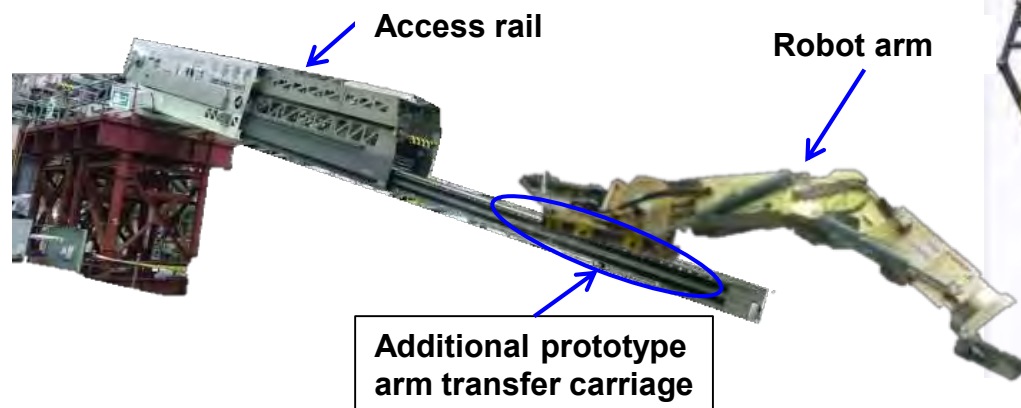

Overall planning drawing of the testing system

6. Implementation details of this project

6.2. Implementation details

2) Development of Element Technology for Retrieval Device Installation

(2) Development of Interference Object Removal during Fuel Debris Retrieval

c. Method to remove interfering objects by the fuel debris retrieval device commonly designed for both the access methods

(ii) Evaluation of the operational performance of the robot arm and access rail combined system

● Outlines of the testing devices

○ Planned camera installation positions

	Robot arm	Access rail
Illustration/ drawing		
Specifications Function	<ol style="list-style-type: none"> 1) Arm front end load capacity: 2,000 kg (based on the assumption of using an approx. $\phi 60$ mm coring bit) 2) Arm length: 7,100 mm (base on the assumption that the arm needs to reach 1.5 m below the bottom of the pedestal) 3) Multi-axis: 6-axis (selected based on the positioning of the end tool) 	<ol style="list-style-type: none"> 1) Three-section extendable rail 2) Guiding the robot arm into the pedestal (based on the assumption that the access rail needs to guide the robot arm to the pedestal opening) 3) Transporting of the unit can between the cell and inside the pedestal
Dimension Weight	<p>700 mm (width) \times 7,100 mm (arm length) \times 920 mm (height) Weight: approx. 4 tons</p>	<p>1,900 mm (width) \times 8,700 mm (length when fully contracted) \times 2,500 mm (height) Fully extended length: 17,000 mm Weight: approx. 24 tons</p>

6. Implementation details of this project

6.2. Implementation details

2) Development of Element Technology for Retrieval Device Installation

(2) Development of Interference Object Removal during Fuel Debris Retrieval

c. Method to remove interfering objects by the fuel debris retrieval device commonly designed for both the access methods

(ii) Evaluation of the operational performance of the robot arm and access rail combined system

- Outlines of the testing devices

A vehicle that could interface the robot arm to the access rail built in the fiscal year two years ago was additionally prototyped, and combination tests were performed with them.

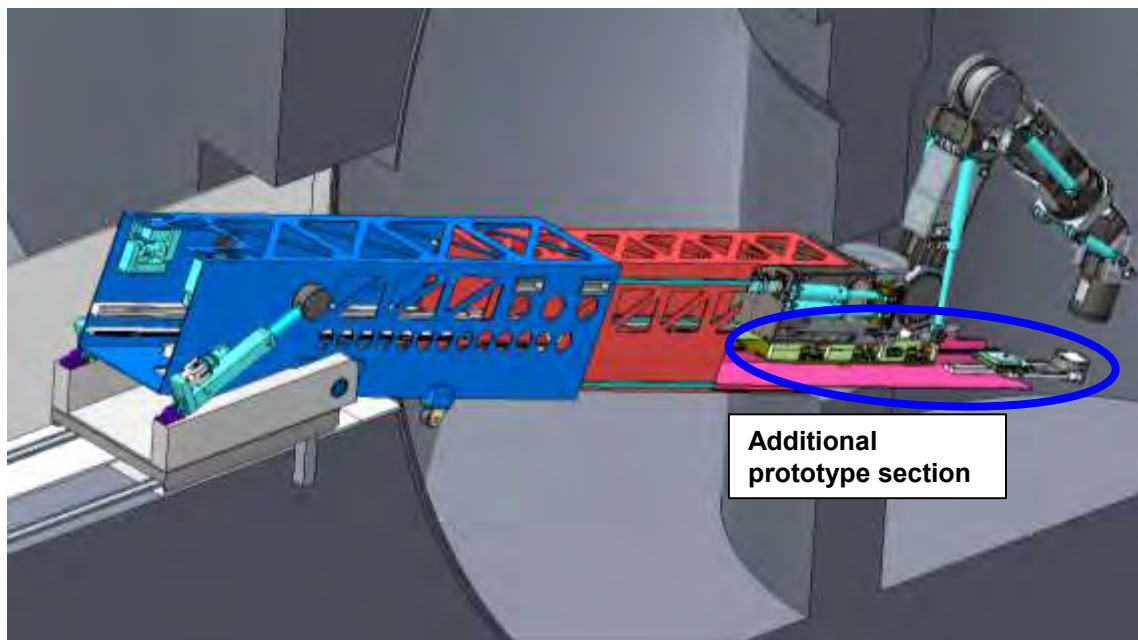

Arm carriage

- Coupling to the transport carriage needs to be provided.
(Coupled to the transport carriage when traveling)
- A fixation mechanism to the access rail needs to be provided.
(Fixed to the access rail when the coupling is released)

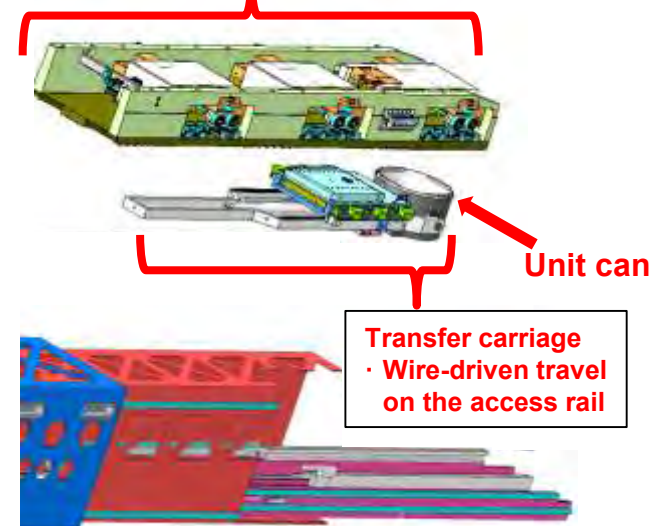

6. Implementation details of this project

6.2. Implementation details

2) Development of Element Technology for Retrieval Device Installation

(2) Development of Interference Object Removal during Fuel Debris Retrieval

c. Method to remove interfering objects by the fuel debris retrieval device commonly designed for both the access methods

(ii) Evaluation of the operational performance of the robot arm and access rail combined system

- Outlines of the testing devices

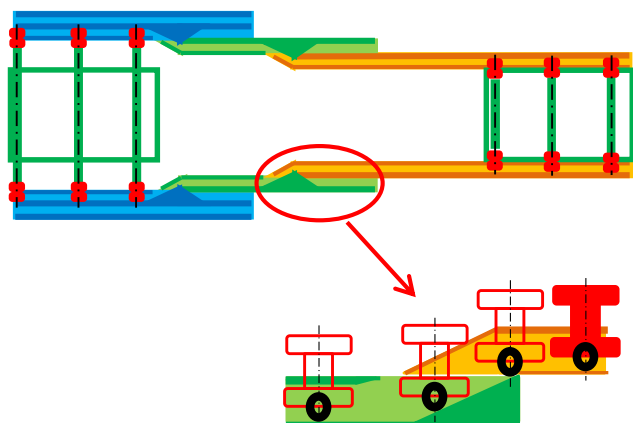

The wheels are guided by the grooves of the access rail so that they can get through the joints.

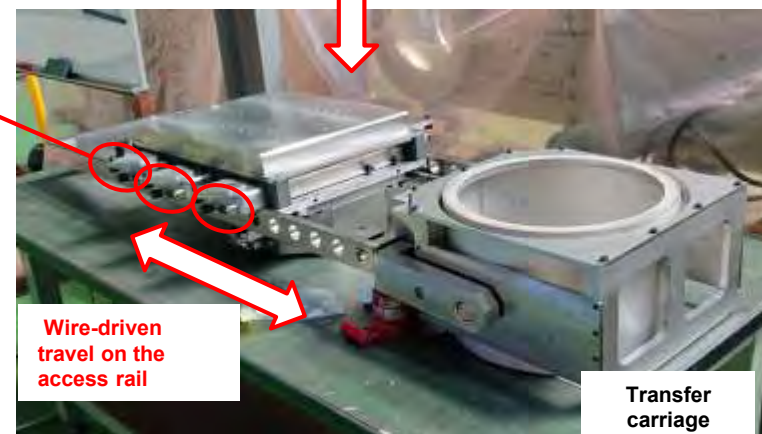
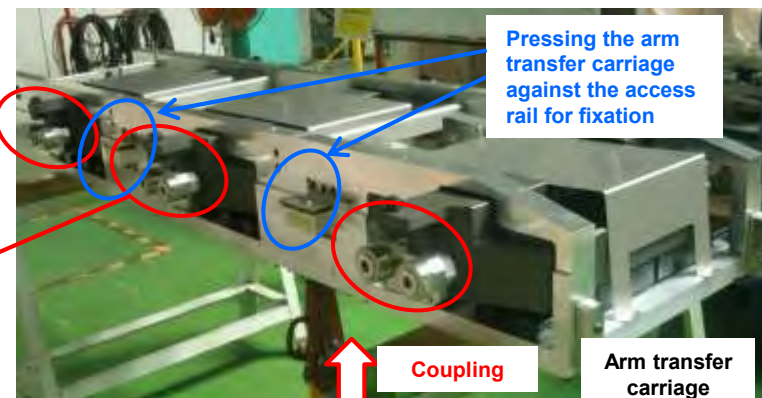
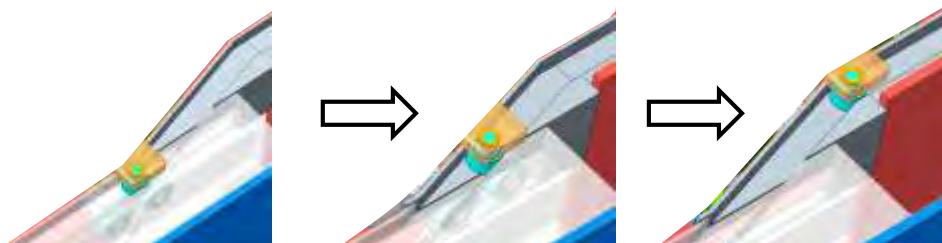

6. Implementation details of this project

6.2. Implementation details

2) Development of Element Technology for Retrieval Device Installation

(2) Development of Interference Object Removal during Fuel Debris Retrieval

c. Method to remove interfering objects by the fuel debris retrieval device commonly designed for both the access methods

(ii) Evaluation of the operational performance of the robot arm and access rail combined system

- Test purpose and evaluation items

A prototype of the arm transfer carriage and a real-scale test system that simulates the structure where the transfer carriage is actually used are built. Using them, the entire operation process is tested, starting from the extension of the access, to evaluate the feasibility of the process and each individual operation.

- 1) Simulating forward/reverse travel of the robot arm and arm transfer carriage on the access rail through the pedestal opening (Evaluation of the transfer carriage's ability to get through access rail joints)
- 2) Simulating fuel debris opening operation in the pedestal
- 3) Simulating the operation to collect dug out fuel debris in the unit can
- 4) Simulating forward/reverse travel of the unit can and can transfer carriage on the access rail (Evaluation of the transfer carriage's ability to get through access rail joints)

6. Implementation details of this project

6.2. Implementation details

2) Development of Element Technology for Retrieval Device Installation

(2) Development of Interference Object Removal during Fuel Debris Retrieval

c. Method to remove interfering objects by the fuel debris retrieval device commonly designed for both the access methods

(ii) Evaluation of the operational performance of the robot arm and access rail combined system

● Test items and evaluation criteria

No.	Test item	Evaluation criteria
1	Installation of the robot arm on the access rail	<ul style="list-style-type: none"> The arm transfer carriage fixation mechanism shall function even if the drive power is lost.
2	Remote extension of the access rail	<ul style="list-style-type: none"> The access rail shall be able to be extended through the full-scale mock-up of the pedestal opening remotely, with the help of images from cameras mounted on the device.
3	Guiding the robot arm into the pedestal	<ul style="list-style-type: none"> The arm transfer carriage shall be able to get through the access rail joints without problems. The arm transfer carriage shall be stable on the access the rail while the robot arm is operating. The arm transfer carriage fixation to the access the rail shall be functional even if the drive power is lost.
4	Manipulation of the robot arm to target interfering objects/fuel debris to start cutting/opening them	<ul style="list-style-type: none"> The robot arm shall be able to be guided to target objects by images sent from cameras mounted on the device.
5	Withstanding the reaction force of the cutting/opening tools cutting interfering objects/ opening fuel debris	<ul style="list-style-type: none"> There shall be no problems in the operation of the robot arm and access rail after the robot arm exerting two tons of pressing force on the floor.
6	Transportation of the unit can to the cell (Travel of the can transfer carriage in the access rail)	<ul style="list-style-type: none"> The can transfer carriage shall be able to descend by self-weight. The arm transfer carriage shall be able to get through the access rail joints without problems.
7	Emergency withdrawal	<ul style="list-style-type: none"> The robot arm shall be able to be withdrawn to the cell by the arm transfer carriage. The access rail shall be able to be extended and contracted. The access rail shall be able to be tilted back to horizontal position.
8	Feasibility of the entire operation process	<ul style="list-style-type: none"> The process from the access rail extension, to the robot arm withdrawal, to the cell shall be able to be performed by remote control. (Any step which cannot be performed remotely shall be classified as an issue and measures to address it shall be developed.)
9	Throughput estimate	<ul style="list-style-type: none"> The operation time of each work step shall be equal to or shorter than expected time.

6. Implementation details of this project

6.2. Implementation details

2) Development of Element Technology for Retrieval Device Installation

(2) Development of Interference Object Removal during Fuel Debris Retrieval

c. Method to remove interfering objects by the fuel debris retrieval device commonly designed for both the access methods

(ii) Evaluation of the operational performance of the robot arm and access rail combined system

● Test results

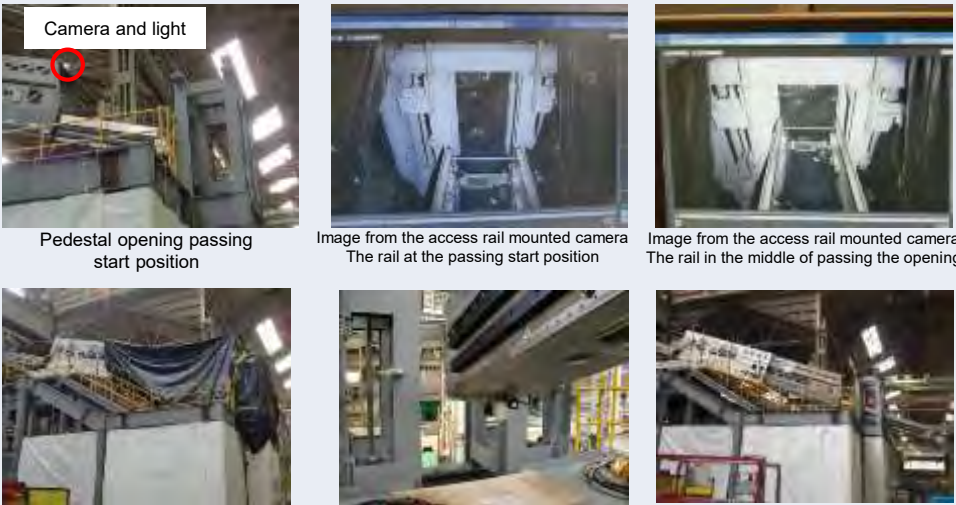
No.	Item	Test results
1	Installation of the robot arm on the access rail	<p>(1) It was demonstrated that the can transfer carriage could be moved to the right position relative to the arm transfer carriage by remote control.</p> <p>(2) It was demonstrated that the can transfer carriage could be coupled to the arm transfer carriage at the above-mentioned position by remote control.</p> <p>(3) It was demonstrated that the arm transfer carriage fixation mechanism was functional even if the power was lost.</p> 
2	Remote extension of the access rail	<p>(1) It was demonstrated that the access rail could be extended remotely by relying on visual monitoring.</p> <p>(2) It was demonstrated that the access rail could be extended and guided into the pedestal through its opening remotely using images (captured in bright conditions) sent from installed cameras.</p> <p>(3) It was demonstrated that the access rail could be extended and guided into the pedestal through its opening remotely using images (captured in dark conditions) sent from installed cameras.</p> <p>==> The light-intensity of the installed lighting was found to be sufficient.</p> 

6. Implementation details of this project

6.2. Implementation details

2) Development of Element Technology for Retrieval Device Installation

(2) Development of Interference Object Removal during Fuel Debris Retrieval

c. Method to remove interfering objects by the fuel debris retrieval device commonly designed for both the access methods

(ii) Evaluation of the operational performance of the robot arm and access rail combined system

● Test results

No.	Item	Test results
3	Guiding the robot arm into the pedestal (Continued to the next page)	<p>(1) Travel of the transfer carriages through the access rail joints</p> <ul style="list-style-type: none"> · It was demonstrated that the transfer carriages could descend by self-weight. · The following problem occurred in the test to pull up the coupled arm transfer carriage and can transfer carriage, and the transfer carriages could not be moved further; the can transfer carriage overturned at one of the access rail joints. <p>==> Design change was made in the wire winch system. Specifically, two separate winch systems were employed so that each transfer carriage could be driven independently. With this new system, it was demonstrated that pulling operations could be performed without problems.</p>

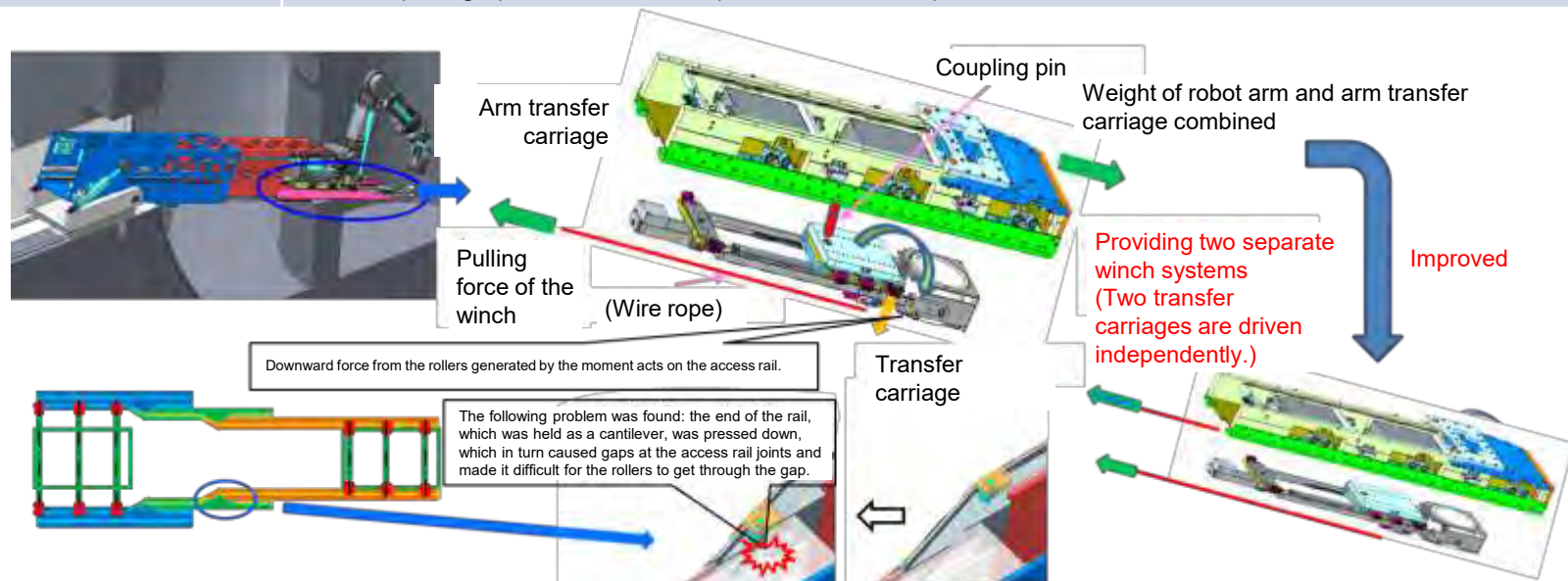

6. Implementation details of this project

6.2. Implementation details







2) Development of Element Technology for Retrieval Device Installation

(2) Development of Interference Object Removal during Fuel Debris Retrieval

c. Method to remove interfering objects by the fuel debris retrieval device commonly designed for both the access methods

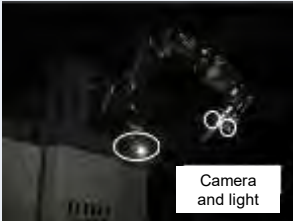
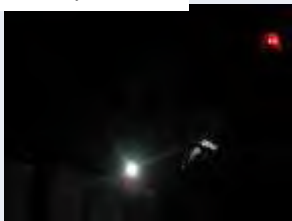
(ii) Evaluation of the operational performance of the robot arm and access rail combined system

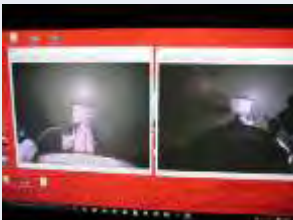
● Test results

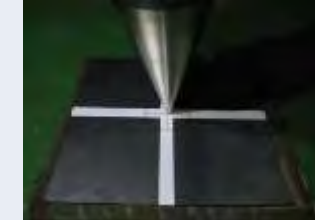
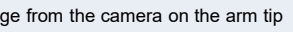
No.	Item	Test results
3	<p>(Continued from the previous page)</p> <p>Guiding the robot arm into the pedestal</p>	<p>(2) It was demonstrated that the fixation mechanism of the arm transfer carriage functioned during the robot arm operation.</p> <p>(3) It was demonstrated that the arm transfer carriage fixation mechanism functioned even if the power was lost.</p> <div style="display: flex; justify-content: space-around;">   </div>
4	<p>Positioning of the robot arm when processing(drilling) interfering objects and fuel debris</p>	<p>(1) It was demonstrated that the arm could be guided to target objects by camera images.</p> <p>==> The light-intensity of the installed lighting was found to be sufficient.</p> <p>(a) Positioning accuracy: 5 mm (distance from the target object)</p> <p>(b) Positioning time When started from the original point of the positioning operation : 5 min When moving from one object to another next to it : 2 min</p> <div style="display: grid; grid-template-columns: repeat(3, 1fr); gap: 5px;"> <div data-bbox="1031 803 1321 1021">  <p>Camera and light</p> </div> <div data-bbox="1338 803 1628 1021">  <p>Original point of the positioning (photographed with flashlight)</p> </div> <div data-bbox="1645 803 1958 1021">  <p>Original point of the positioning (photographed without flashlight)</p> </div> <div data-bbox="1031 1089 1321 1306">  <p>During positioning</p> </div> <div data-bbox="1338 1089 1628 1306">  <p>Image from the camera on the arm tip</p> </div> <div data-bbox="1645 1089 1958 1306">  <p>Image from the camera on the access rail front end</p> </div> <div data-bbox="1031 1318 1321 1349">  <p>Positioning completed</p> </div> </div>

6. Implementation details of this project

6.2. Implementation details





2) Development of Element Technology for Retrieval Device Installation

(2) Development of Interference Object Removal during Fuel Debris Retrieval

c. Method to remove interfering objects by the fuel debris retrieval device commonly designed for both the access methods

(ii) Evaluation of the operational performance of the robot arm and access rail combined system

● Test results

No.	Item	Test results
5	Withstanding the reaction force when processing (drilling) interfering objects and fuel debris	<p>(1) It was demonstrated that the robot arm and access rail combined structure could withstand two tons of reaction force. (It was demonstrated that the robot arm and access rail could be operated without problems after two tons of reaction force was applied.)</p> <p>(2) It was found that the access rail leaned sideways a little due to uneven loading of the arm when the arm was swung to the side. ==> This was identified as a potential issue to be addressed in application to the actual site (Idea of measures: Strengthen the clamp)</p> <div style="display: flex; flex-wrap: wrap;">   <div style="border: 1px solid red; padding: 5px; margin: 5px;"> <p>The access rail leans sideways by approx. 0.8° due to uneven load of the arm weight (Before applying a load of 2 tons) ==> The clamp needs to be strengthened with the access rail deployed for actual operation at the site.</p> </div>   <div style="border: 1px solid red; padding: 5px; margin: 5px;"> <p>Planned position of the additional clamp (Adding a brace between the side of the robot arm and the inside wall of the pedestal opening)</p> </div> <div style="border: 1px solid red; padding: 5px; margin: 5px;"> <p>Position of the existing clamp (Adding a brace between the side of the access rail and the inside wall of the pedestal opening)</p> </div> </div>

6. Implementation details of this project

6.2. Implementation details

2) Development of Element Technology for Retrieval Device Installation

(2) Development of Interference Object Removal during Fuel Debris Retrieval

c. Method to remove interfering objects by the fuel debris retrieval device commonly designed for both the access methods

(ii) Evaluation of the operational performance of the robot arm and access rail combined system

● Test results

No.	Item	Test results
6	Transportation of the unit can to the cell (Travel of the can transfer carriage in the access rail)	<p>(1) It was demonstrated that the can transfer carriage could descend by self-weight.</p> <p>(2) It was demonstrated that the can transfer carriage could get through the access rail joints without problems.</p>
7	Emergency withdrawal (Continued to the next page)	<p>It was demonstrated that emergency withdrawal operation by a crane and wire rope was feasible.</p> <p>(1) Withdrawal of the robot arm to the cell (Reverse travel of the arm transfer carriage)</p> <p>(2) Contraction of the access rail</p> <p>(3) Tilting the access rail back to horizontal position</p> <p>It was demonstrated that forcing the motor and speed reducer to operate didn't cause any problems and the devices were able to be withdrawn to the cell.</p>



Travel of the can transfer carriage in the access rail

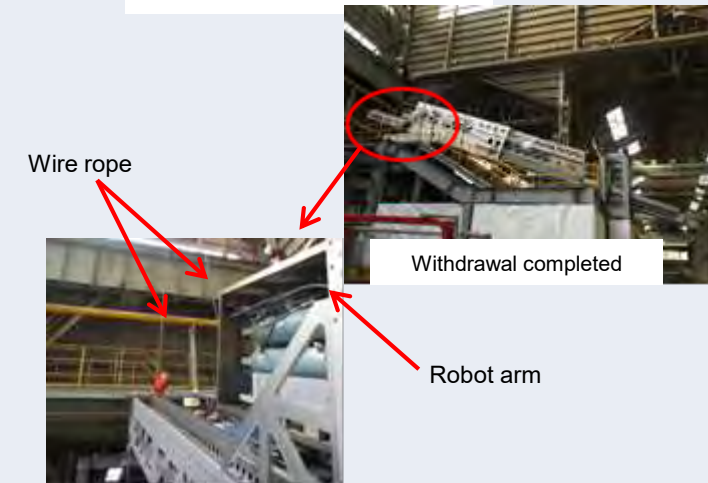

Withdrawal of the robot arm to the cell (Reverse travel of the arm transfer carriage)

6. Implementation details of this project

6.2. Implementation details







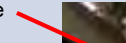

2) Development of Element Technology for Retrieval Device Installation

(2) Development of Interference Object Removal during Fuel Debris Retrieval

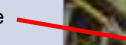
c. Method to remove interfering objects by the fuel debris retrieval device commonly designed for both the access methods

(ii) Evaluation of the operational performance of the robot arm and access rail combined system

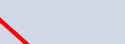
● Test results

No.	Item	Test results	
7	(Continued from the previous page) Emergency withdrawal	<p>Wire rope </p>  <p>Contraction started</p> <p>Wire rope </p>  <p>Contraction completed</p> <p>Contraction of the access rail</p>	<p>Wire rope </p>  <p>Tilting back to level started</p> <p>Wire rope </p>  <p>Tilting back to level completed</p> <p>Tilting the access rail back to horizontal position</p>

6. Implementation details of this project

6.2. Implementation details

2) Development of Element Technology for Retrieval Device Installation

(2) Development of Interference Object Removal during Fuel Debris Retrieval

c. Method to remove interfering objects by the fuel debris retrieval device commonly designed for both the access methods

(ii) Evaluation of the operational performance of the robot arm and access rail combined system

● Test results

No.	Item	Test results
8	Feasibility of the entire operation process	It was demonstrated through the above-described tests that the entire operation process from the extension of the access rail to the withdrawal of the robot arm to the cell could be performed by remote control. Issues to be addressed for finalizing the design of the devices and operation process applicable to the actual operation at the site were identified through the tests, and measures were studied. See "Issues and action policy"
9	Throughput estimate	The result of the operation time measurement is summarized by individual work steps on the next page. The transfer carriages' travel time exceeded the expected time. In addition, throughput needs to be further improved. For these reasons, increasing the speed of the transfer carriages by enhancing the winch capacity was studied. See "Issues and action policy"

6. Implementation details of this project

6.2. Implementation details







2) Development of Element Technology for Retrieval Device Installation

(2) Development of Interference Object Removal during Fuel Debris Retrieval

c. Method to remove interfering objects by the fuel debris retrieval device commonly designed for both the access methods

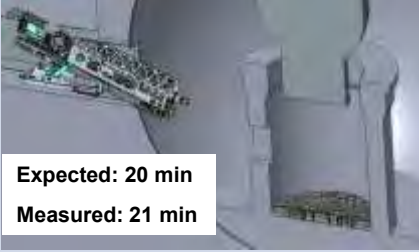
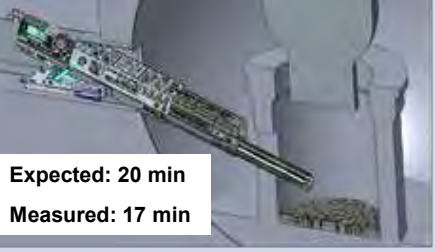
(ii) Evaluation of the operational performance of the robot arm and access rail combined system

- Test result (Item No. 9 Throughput estimate)

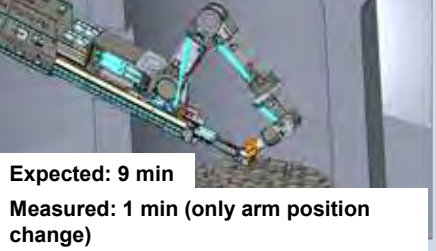
<p>1. Transporting the robot arm into the cell</p>	<p>2. Setting the robot arm and arm transfer carriage on the access rail</p>	<p>3. Tilting the access rail toward the opening for CRD exchange work</p>	<p>4. Extending the access rail</p>
 <p>This step was not included in the test plan.</p>	 <p>This step was not included in the test plan.</p>	 <p>Expected: 20 min Measured: 21 min</p>	 <p>Expected: 20 min Measured: 17 min</p>
<p>5. Moving the robot arm forward and unfolding it</p>	<p>6. Processing and grabbing fuel debris by the robot arm</p>	<p>7. Changing the position of the robot arm to that for fuel debris collection mode and pushing the unit can forward</p>	<p>8. Collecting the grabbed fuel debris in the unit can on the can transfer carriage on the access rail</p>
 <p>Expected: 20 min Measured: 36 min</p>	 <p>Positioning Expected: 2 min Measured: 2 min</p> <p>Processing and grabbing was not included in the test plan.</p>	 <p>Expected: 3 min Measured: 2 min</p>	 <p>Expected: 9 min Measured: 1 min (only arm position change)</p> <p>The collection of fuel debris was not included in the test plan.</p>

6. Implementation details of this project

6.2. Implementation details









2) Development of Element Technology for Retrieval Device Installation

(2) Development of Interference Object Removal during Fuel Debris Retrieval

c. Method to remove interfering objects by the fuel debris retrieval device commonly designed for both the access methods

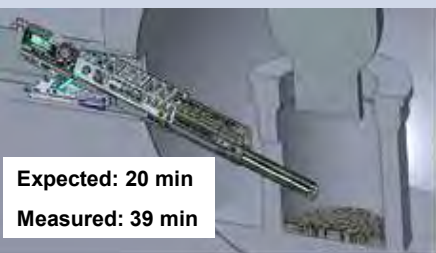
(ii) Evaluation of the operational performance of the robot arm and access rail combined system

- Test result (Item No. 9 Throughput estimate)

<p>9. Transporting the unit can to the cell by the can transfer carriage</p>	<p>10. Accessing the unit can by the manipulator in the cell</p>	<p>11. Storing the fuel debris-containing unit can in the storage canister by the manipulator in the cell</p>	<p>12. Transporting the unit can transfer carriage to the front end of the access rail</p>
 <p>Expected: 12 min Measured: 23 min</p>	 <p>This step was not included in the test plan.</p>	 <p>This step was not included in the test plan.</p>	 <p>Expected: 12 min Measured: 23 min</p>
<p>13. Withdrawing the robot arm to the cell</p>	<p>14. Contracting the access rail</p>	<p>15. Tilting the access rail back to horizontal position</p>	<p>16. Transporting the robot arm out of the cell</p>
 <p>Expected: 20 min Measured: 39 min</p>	 <p>Expected: 20 min Measured: 19 min</p>	 <p>Expected: 20 min Measured: 23 min</p>	 <p>This step was not included in the test plan.</p>

6. Implementation details of this project

6.2. Implementation details

2) Development of Element Technology for Retrieval Device Installation

(2) Development of Interference Object Removal during Fuel Debris Retrieval

c. Method to remove interfering objects by the fuel debris retrieval device commonly designed for both the access methods

(ii) Evaluation of the operational performance of the robot arm and access rail combined system

● Achievements

- Feasibility of the entire operation process from guiding the device into the pedestal, opening and removing fuel debris, to collecting it.

The feasibility of the entire operation process, including the functions of the transfer carriages and emergency withdrawal methods, was demonstrated, and the method and route to transport various devices and collection cans between the cell and the inside of the pedestal was established.

In addition, the total operation time for the transportation of devices and cans between the cell and the inside of the pedestal was measured so as to be more accurate than that estimated through desk engineering work. Accordingly, the estimation of throughput became more accurate.

- Remote operation performance of the entire process from guiding the device into the pedestal, opening and removing fuel debris, to collecting it based on camera images.

Remote operation performance was evaluated with currently planned number and layout of cameras, and the number of cameras and their layout were reviewed and optimized to enable stable remote control of the entire process based on the result.

6. Implementation details of this project

6.2. Implementation details



2) Development of Element Technology for Retrieval Device Installation

(2) Development of Interference Object Removal during Fuel Debris Retrieval

c. Method to remove interfering objects by the fuel debris retrieval device commonly designed for both the access methods

(ii) Evaluation of the operational performance of the robot arm and access rail combined system

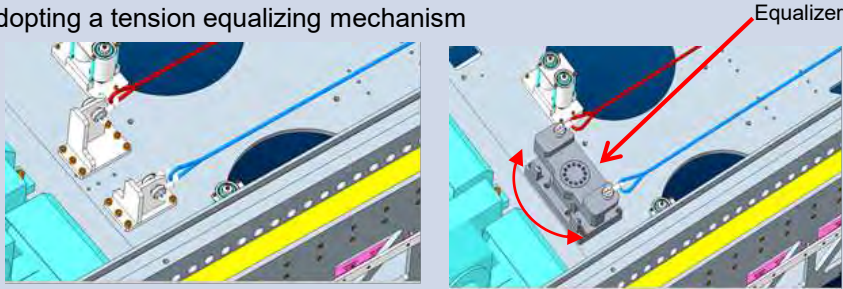
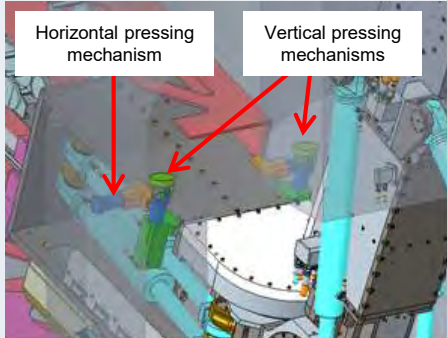
- Issues and action policy

No.	Issues	Action policy*
1	<ul style="list-style-type: none"> · Wire rope entanglement in the electric winch <p>When a tension is applied to either one of two wire ropes of the two electric winches, the other gets loose and may cause the entanglement of them in the operating winch.</p>	<p>Adopting a tension equalizing mechanism</p> 
2	<ul style="list-style-type: none"> · Bend and torsion of the access rail due to the load of the robot arm <p>In contrary to the assumption that the vertical load of the robot arm acting on the access rail (reaction force during opening) should be counterbalanced by its weight, results of the load test revealed the occurrence of bend and torsion in the access rail, which could lead to the robot arm tip misalignment.</p>	<p>Adding a mechanism that presses the robot arm against the pedestal opening.</p> <p>Before improvement</p>  <p>After improvement</p> 

*: Contents of the action policy will be worked on through future engineering activities.

6. Implementation details of this project

6.2. Implementation details

2) Development of Element Technology for Retrieval Device Installation

(2) Development of Interference Object Removal during Fuel Debris Retrieval

c. Method to remove interfering objects by the fuel debris retrieval device commonly designed for both the access methods

(ii) Evaluation of the operational performance of the robot arm and access rail combined system

- Issues and action policy

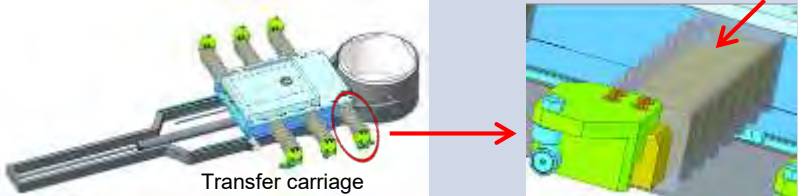
No.	Issues	Action policy*
3	<p>· Decommissioning efficiency improvement</p> <p>All devices and equipment used in the PCV and the pedestal must be decontaminated and material adhering to them must be removed by cleaning before transporting them out from the cell. For this reason, all devices and equipment used in actual operation at the site are required to be equipped with foreign objects intrusion prevention measures for improvement of decommissioning efficiency.</p>	<p>Implementing foreign objects intrusion prevention measures for improvement of decommissioning efficiency. An exemplary measure is shown below.</p> 

*: Contents of the action policy will be worked on through future engineering activities.

6. Implementation details of this project

6.2. Implementation details

2) Development of Element Technology for Retrieval Device Installation

(2) Development of Interference Object Removal during Fuel Debris Retrieval

c. Method to remove interfering objects by the fuel debris retrieval device commonly designed for both the access methods

(ii) Evaluation of the operational performance of the robot arm and access rail combined system

● Issues and action policy

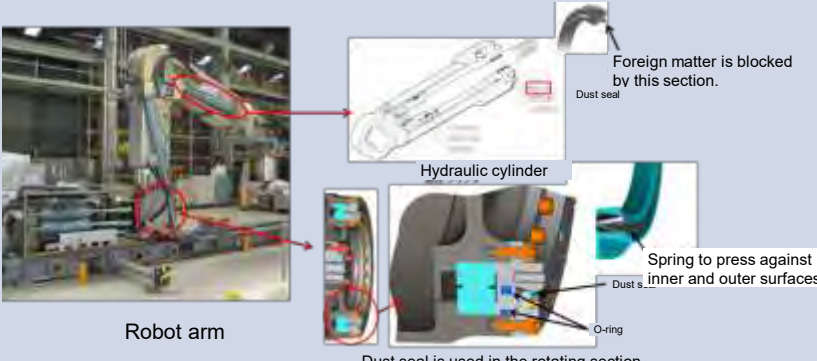
No.	Issues	Action policy*
4	<p>· Measures to prevent transfer carriage stuck</p> <p>A transfer carriage stuck may occur and it cannot be withdrawn to the cell if chips, like a small piece of fuel debris, come into the transfer carriage guiding rails of the access rail. For this reason, the transfer carriage guiding rails of the access rail used in actual operation at the site, are required to be equipped with foreign objects prevention measures as well as a mechanism to remove such matter in the traveling track.</p>	<p>Adding cleaning nozzles and scrapers to remove foreign objects in the front and back of the transfer carriage Implementing waterproof and foreign objects prevention measures for the robot arm as well</p>   <p>Dust seal is used in the rotating section.</p>

*: Contents of the action policy will be worked on through future engineering activities.

6. Implementation details of this project

6.2. Implementation details

2) Development of Element Technology for Retrieval Device Installation

(2) Development of Interference Object Removal during Fuel Debris Retrieval

c. Method to remove interfering objects by the fuel debris retrieval device commonly designed for both the access methods

(ii) Evaluation of the operational performance of the robot arm and access rail combined system

- Issues and action policy

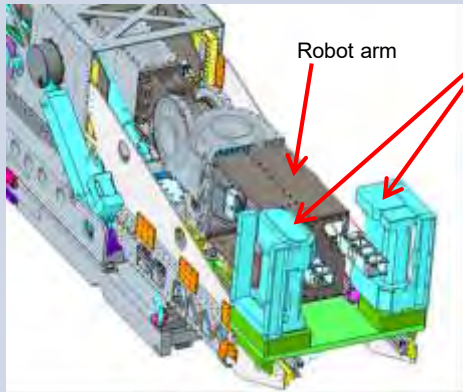
No.	Issues	Action policy*
5	<ul style="list-style-type: none"> · Introduction of separate transfer carriage driving mechanisms <p>The following problem occurred in the test to pull up the coupled arm transfer carriage and can transfer carriage, and the transfer carriages could not be moved further; the can transfer carriage overturned at one of the access rail joints.</p>	<p>Adding winches dedicated to drive the arm transfer carriage to introduce two wire drive systems, each of which drives the two transfer carriages independently</p>  <p>The image is a 3D CAD model of a complex mechanical system. It features a central robot arm (labeled 'Robot arm') and two electric winches (labeled 'Electric winches') positioned on either side. The entire assembly is mounted on a base with wheels. Red arrows point from the text labels to the corresponding parts in the model.</p>
6	<ul style="list-style-type: none"> · Throughput improvement <p>The transfer carriages' travel time exceeded expected time. In addition, throughput needs to be further improved.</p>	<p>Considering increasing the winch capacity since there is a space for a larger winch</p>

*: Contents of the action policy will be worked on through future engineering activities.

6. Implementation details of this project

6.2. Implementation details

2) Development of Element Technology for Retrieval Device Installation

(2) Development of Interference Object Removal during Fuel Debris Retrieval

c. Method to remove interfering objects by the fuel debris retrieval device commonly designed for both the access methods

(ii) Evaluation of the operational performance of the robot arm and access rail combined system

- Objectives and achievement assessment

Objectives of the test		Achievement level	
1	Feasibility of the entire operation process The entire operation process from guiding the arms and access rail into the pedestal, opening and removing fuel debris, to collecting it shall be able to be performed remotely.	Achieved	<ul style="list-style-type: none"> The entire operation process, from the extension of the access rail, to the withdrawal of the robot arm to the cell, can be performed by remote control.
1)	Guiding the robot arm into the pedestal	Achieved	<ul style="list-style-type: none"> The arm transfer carriage can get through the access rail joints without problems.
2)	Method to fix robot arms to the rail	Achieved	<ul style="list-style-type: none"> It was demonstrated that the fixation mechanism of the arm transfer carriage functioned during the robot arm operation. It was demonstrated that the arm transfer carriage fixation mechanism functioned even if the power was lost.
3)	Method to transport the unit can to the cell	Achieved	<ul style="list-style-type: none"> It was demonstrated that the can transfer carriage could descend by self-weight. The can transfer carriage can get through the access rail joints without problems.

6. Implementation details of this project

6.2. Implementation details

2) Development of Element Technology for Retrieval Device Installation

(2) Development of Interference Object Removal during Fuel Debris Retrieval

c. Method to remove interfering objects by the fuel debris retrieval device commonly designed for both the access methods

(ii) Evaluation of the operational performance of the robot arm and access rail combined system

- Objectives and achievement assessment

Objectives of the test		Achievement level	
2	Feasibility of emergency withdrawal methods that take into consideration possible failures The robot arm and access rail shall be able to be withdrawn to the inside of the cell in case the drive of them is lost.	Achieved	<ul style="list-style-type: none"> • It was demonstrated through the test that simulated an emergency situation and said withdrawal operation that the devices could be withdrawn by the winches in the cell in case of emergency.
1)	Withdrawal of the robot arm to the cell (Reverse travel of the arm transfer carriage)	Achieved	<ul style="list-style-type: none"> • It was demonstrated that the robot arm could be withdrawn by a crane and wire rope.
2)	Contraction of the access rail	Achieved	<ul style="list-style-type: none"> • It was demonstrated that forcing the motor and speed reducer to run didn't cause any problems and the access rail could be withdrawn by a crane and wire rope.
3)	Tilting the access rail back to horizontal position	Achieved	<ul style="list-style-type: none"> • It was demonstrated that forcing the motor and speed reducer to run didn't cause any problems and the access rail could be withdrawn by a crane and wire rope.

6. Implementation details of this project

6.2. Implementation details

2) Development of Element Technology for Retrieval Device Installation

(2) Development of Interference Object Removal during Fuel Debris Retrieval

c. Method to remove interfering objects by the fuel debris retrieval device commonly designed for both the access methods

(ii) Evaluation of the operational performance of the robot arm and access rail combined system

- Objectives and achievement assessment

Objectives of the test		Achievement level	
3	Remote operation performance of the entire process based on camera images The control of the access rail extension and the positioning of the robot arm tip to targets shall be able to be performed remotely, by the help of images from cameras mounted on the device.	Achieved	<ul style="list-style-type: none"> • Operation control that relies on images from installed cameras was found to be feasible.
1)	Method to guide the access rail through the pedestal opening	Achieved	<ul style="list-style-type: none"> • The number of cameras and lighting arrangement required for remote control was made clear.
2)	Method to manipulate the robot arm tip to targets	Achieved	<ul style="list-style-type: none"> • The number of cameras and lighting arrangement required for remote control was made clear.
4	Measurement of the operation time of each work step for throughput estimation The operation time of each work step shall be equal to or shorter than expected time.	Not achieved	<ul style="list-style-type: none"> • The transfer carriages' travel time exceeded expected time. • Further improvement of throughput is also needed. ==> Increase in the transfer carriage travel speed is projected by increasing the winch capacity.

6. Implementation details of this project

6.2. Implementation details

2) Development of Element Technology for Retrieval Device Installation

(2) Development of Interference Object Removal during Fuel Debris Retrieval

c. Method to remove interfering objects by the fuel debris retrieval device commonly designed for both the access methods

(ii) Evaluation of the radiation resistance of the robot arm hydraulic oil

- Development objectives
 - Perform radiation resistance evaluation tests on hydraulic oils and obtain data concerning radiation resistance in order to evaluate the maintainability and feasibility of the robot arm.
(Obtained data will be used to select a hydraulic oil used for actual operation at the site and to develop a maintenance plan.)
- Issues to be solved
 - The robot arm requires high output power and high-precision positioning. For this reason, the use of not a water hydraulic system but an oil hydraulic system (with non-flammable hydraulic oil) is planned. Since no data is provided for the radiation resistance of hydraulic oil, the necessity and frequency of maintenance cannot be determined.
- Approaches to development
 - Hydraulic oil selection
 - Study of test and evaluation methods
 - Radiation resistance test
- Test conditions
 - Dose rate : Irradiated at a dose rate of 5 kGy/h
(Set at a greater dose rate than 500 Gy/h, an estimated dose rate in the reactor, with the aim of performing an accelerated test)
 - Cumulative dose : Irradiated until the cumulative dose reaches 2,000 kGy
(Set at a greater dose than 1,000 kGy, target radiation resistance, taking into account margin)

6. Implementation details of this project

6.2. Implementation details

2) Development of Element Technology for Retrieval Device Installation

(2) Development of Interference Object Removal during Fuel Debris Retrieval

c. Method to remove interfering objects by the fuel debris retrieval device commonly designed for both the access methods

(iii) Evaluation of the radiation resistance of the robot arm hydraulic oil

● Development status

➤ Hydraulic oil selection

In addition to the hydraulic oil used in the robot arm function evaluation tests until last fiscal year, hydraulic oils under development by Company A for radiation resistance improvement were selected along with a typical hydraulic oil for comparative evaluation. (Hydraulic oils type-1) to type-3))

Properties and other information of tested hydraulic oils

No.	Item	Hydraulic oil type-1	Hydraulic oil type-2	Hydraulic oil type-3
1	Kinetic viscosity [mm ² /s]	47.5 [40° C]	46.7 [40° C]	46 [40° C]
2	Ignition point	300 [° C]	282 [° C]	262 [° C]
3	Assumed risk	Increase in viscosity and gas generation by deconfiguration due to radiation		
4	Others	<ul style="list-style-type: none"> Fatty acid ester Hydraulic oil used in the prototype of a large hydraulic robot arm 	<ul style="list-style-type: none"> Fatty acid ester Hydraulic oil under development by a manufacturer for radiation resistance improvement 	<ul style="list-style-type: none"> Typical mineral hydraulic oil Typical hydraulic oil
5	Manufacturer	Company A	Company A	Company B

6. Implementation details of this project

6.2. Implementation details

2) Development of Element Technology for Retrieval Device Installation

(2) Development of Interference Object Removal during Fuel Debris Retrieval

c. Method to remove interfering objects by the fuel debris retrieval device commonly designed for both the access methods

(iii) Evaluation of the radiation resistance of the robot arm hydraulic oil

- Development status

- Radiation resistance test

Containers that contained the sample hydraulic oils were brought to a radiation test facility and irradiated at a dose rate of approx. 5 kGy/h.

Amount of gas generation: Evaluated by irradiating the samples at a dose rate of 25/50/75/100 kGy/h until the cumulative dose reaches 100 kGy

Property evaluation: Evaluated by irradiating the samples at a dose rate of 250/500/1,000/1,500/2,000 kGy/h until the cumulative dose reaches 2,000 kGy

- Evaluation

- The amount of gas generation was measured.

(Reason) The performance of the arm is degraded by the mixing of bubbles that is caused by gas generation.

- Properties (viscosity and ignition point) were tested.

(Reasons)

Increased viscosity degrades the performance of the arm including the motion speed down and pressure deficiency.

Lower ignition point may demand risk reduction measures (such as leak prevention and care for ignition sources).

6. Implementation details of this project

6.2. Implementation details

2) Development of Element Technology for Retrieval Device Installation

(2) Development of Interference Object Removal during Fuel Debris Retrieval

c. Method to remove interfering objects by the fuel debris retrieval device commonly designed for both the access methods

(iii) Evaluation of the radiation resistance of the robot arm hydraulic oil

- Development status

- Details of irradiation tests

- [1] Test to evaluate gas generation

Place: Radiation Research Center of Osaka Prefecture University

Time: December 19 to 21, 2018 (daytime continuous irradiation)

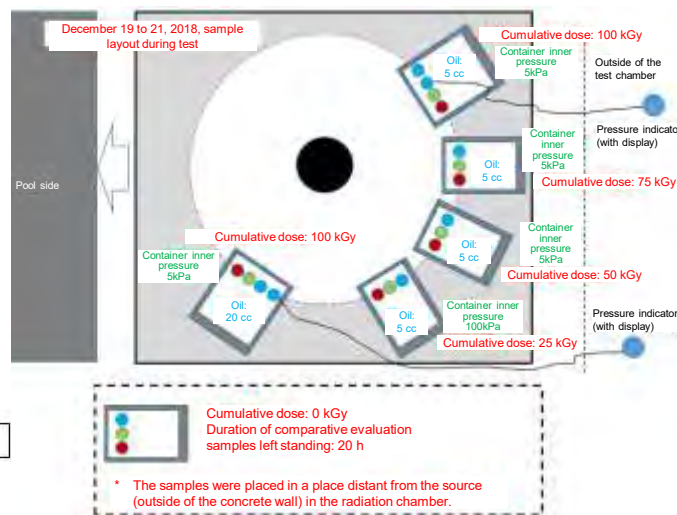
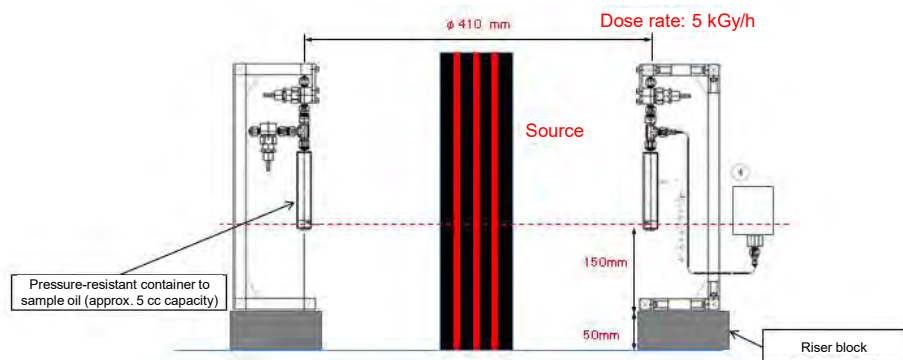

6. Implementation details of this project

6.2. Implementation details

2) Development of Element Technology for Retrieval Device Installation

(2) Development of Interference Object Removal during Fuel Debris Retrieval

c. Method to remove interfering objects by the fuel debris retrieval device commonly designed for both the access methods

(iii) Evaluation of the radiation resistance of the robot arm hydraulic oil

● Development status

➤ Details of irradiation tests

[2] Property test

Place: Radiation application development association, Takasaki laboratory

Time: November 26 to December 13, 2018 (day-and-night continuous irradiation)

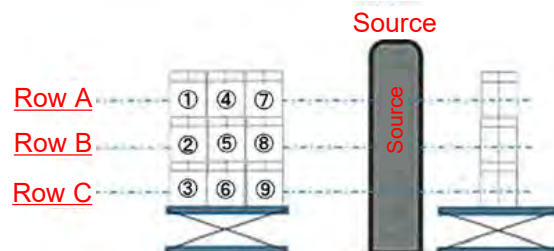

- Aminogray (alanine dosimeter made by Hitachi Cable, Ltd., currently Hitachi Metals, Ltd.) was used.
- Aminogray was placed in the center of the arrangement of cans No.1 to No.9 that contained sample oils

Distance from the center of the source (cm)	80		72		64	
	Position	Dose rate (kGy/h)	Position	Dose rate (kGy/h)	Position	Dose rate (kGy/h)
	①	5.36	④	5.35	⑦	5.55
	②	5.29	⑤	5.26	⑧	5.47
	③	5.73	⑥	5.36	⑨	5.50

* Irradiation time was set based on an average dose rate of 5.4 kGy/h.



6. Implementation details of this project

6.2. Implementation details

2) Development of Element Technology for Retrieval Device Installation

(2) Development of Interference Object Removal during Fuel Debris Retrieval

c. Method to remove interfering objects by the fuel debris retrieval device commonly designed for both the access methods

(iii) Evaluation of the radiation resistance of the robot arm hydraulic oil

- Development status

- Evaluation test results

- [1] Test to evaluate gas generation

G-values* yielded by calculation using the test data are: 2.7 to 3.0 for oil type-3 (mineral oil), 1.0 to 1.2 for oil type-1 (ester oil), and 1.2 to 1.5 for oil type-2 (ester oil). (All values are approximate.)

G-values from literature are 2.8 for aliphatic hydrocarbon base oil (LP350) and 1.5 for fatty acid ester oil (Diethyl sebacate). Although the value of oil type-1 (ester oil) appears a little less than those values, G-values obtained by the test can be considered to coincide roughly with those from literature.

Thus, G-values obtained by the test were determined to be adequate. In addition, G-values obtained from the samples exposed to different dose rates were constant as far as other conditions were the same.

These results suggest that the degree of deconfiguration reaction is almost the same within the cumulative dose used in this test (max. 0.1 MGy).

* G-value: Number of atoms or molecules of concerned chemical species produced from a given solution as a result of the solution absorbing 100 eV of radiation energy

Aliphatic hydrocarbon oil

Table 1 G-values of gases produced from base oils

Sample	Mineral oils		Ester oil	Aromatic oils	
	LP-350	N-350	Diethyl sebacate	Alkyl diphenyl ether	Polyphenyl-ether
G (total gas)	2.8	1.4	1.5	5.6×10^{-1}	6.6×10^{-1}
G (H ₂)	2.7	1.3	9.9×10^{-1}	5.3×10^{-1}	6.1×10^{-1}
G (CH ₄)	5.1×10^{-2}	3.9×10^{-2}	2.6×10^{-2}	8.0×10^{-3}	—
G (C ₂ H ₆)	1.4×10^{-2}	9.7×10^{-3}	2.7×10^{-2}	3.0×10^{-3}	—
G (C ₃ H ₈)	1.7×10^{-2}	2.4×10^{-2}	5.7×10^{-2}	9.7×10^{-3}	—
G (CO)	—	—	3.4×10^{-2}	—	—
G (CO ₂)	—	—	1.5×10^{-1}	—	—

Fatty acid ester oil

Figure 8 G-values of gases produced from base oils (Hayakawa, et al., Journal of Atomic Energy Society of Japan, Vol. 26, No. 7, 1984)

6. Implementation details of this project

6.2. Implementation details

2) Development of Element Technology for Retrieval Device Installation

(2) Development of Interference Object Removal during Fuel Debris Retrieval

c. Method to remove interfering objects by the fuel debris retrieval device commonly designed for both the access methods

(iii) Evaluation of the radiation resistance of the robot arm hydraulic oil

- Development status

- Evaluation test results

- [2] Property test

Oil property analysis results revealed that hydraulic oils type-1 and -2 caused significant change in their kinetic viscosity while sludge generation was small.

Since the degree of viscosity change is heavily dependent on the cumulative dose exposed, a permissible cumulative dose must be set clearly when these oils are used in actual operation.

As to hydraulic oil type-3, the generation of sludge was observed while change in properties was small. For this reason, caution must be used for clogging and similar problems in the piping system.

In conclusion, hydraulic oil type-1 is considered to be the most suitable based on an overall assessment.

6. Implementation details of this project

6.2. Implementation details

2) Development of Element Technology for Retrieval Device Installation

(2) Development of Interference Object Removal during Fuel Debris Retrieval

c. Method to remove interfering objects by the fuel debris retrieval device commonly designed for both the access methods

(iii) Evaluation of the radiation resistance of the robot arm hydraulic oil

● Achievements

- It was made clear by the calculation of G-values of produced gases using data from these tests that the degree of deconfiguration reaction is almost the same. Generated gases cause adverse effects (bubbles) to the performance of the hydraulic cylinder. To prevent this problem, air bleeding needs to be performed. The criterion of a cumulative dose in terms of gas generation (approx. 87 kGy) described in the paper “Research and Development of Seismic Restraint Snubbers (1)” published in the Journal of Atomic Energy Society of Japan, Vol. 33, No. 1 (1991) was quoted. It was determined to monitor a cumulative dose and perform air bleeding when it reaches this criterion.
(equivalent to 174 h with a dose rate of 0.5 kGy/h)
- It was found by the result of the oil property test performed, following the irradiation test, that the frequency of hydraulic oil change needed to be determined by the maximum permissible cumulative dose in terms of kinetic viscosity increase. The maximum permissible cumulative dose in terms of kinetic viscosity increase was approx. 500 kGy. It was determined to monitor the cumulative dose and perform an oil change when it reaches this criterion.
(equivalent to 1,000 h with a dose rate of 0.5 kGy/h)

* Air bleeding and an oil change will be performed by connecting the rod side and head side of the cylinder with a bypass pipe and feeding oil.

6. Implementation details of this project

6.2. Implementation details

2) Development of Element Technology for Retrieval Device Installation

(2) Development of Interference Object Removal during Fuel Debris Retrieval

c. Method to remove interfering objects by the fuel debris retrieval device commonly designed for both the access methods

(iii) Evaluation of the radiation resistance of the robot arm hydraulic oil

● Issues and action policy

No.	Issues	Action policy*
1	Selection of hydraulic oils for actual operation at the site and maintenance plan	Selecting hydraulic oils for actual operation at the site based on the radiation resistance data obtained by the test Developing maintenance plan, including the necessity, frequency, and method of hydraulic oil change
2	Evaluation of the robot arm performance with hydraulic oil exposed to radiation	Testing the performance of a single axis cylinder and hydraulic manipulator with hydraulic oil exposed to radiation to determine its applicability to actual operation at the site and the adequacy of the maintenance plan

*: Contents of the action policy will be worked on through future engineering activities.

6. Implementation details of this project

6.2. Implementation details

2) Development of Element Technology for Retrieval Device Installation

(2) Development of Interference Object Removal during Fuel Debris Retrieval

c. Method to remove interfering objects by the fuel debris retrieval device commonly designed for both the access methods

(iv) Development of hydraulic manipulator force control methods

- Development objectives
 - Estimation of force acting on the cylinder and development of force control methods based on the estimated force
 - No trade-off between position control and power control (Both must meet requirements.)
- Issues
 - The position of the robot arm tip and arm press down force need to be controlled during fuel debris opening by the arm (to deal with the fluctuation of opening reaction force occurring while the arm tip must be kept at a fixed position, for example). Position control was studied in last fiscal year. Force control has not been studied yet.
- Approaches to development
 - Study of force estimation methods
 - Study of force control methods
 - Force estimation and force control method applicability evaluation through tests with hydraulic manipulator and cylinder

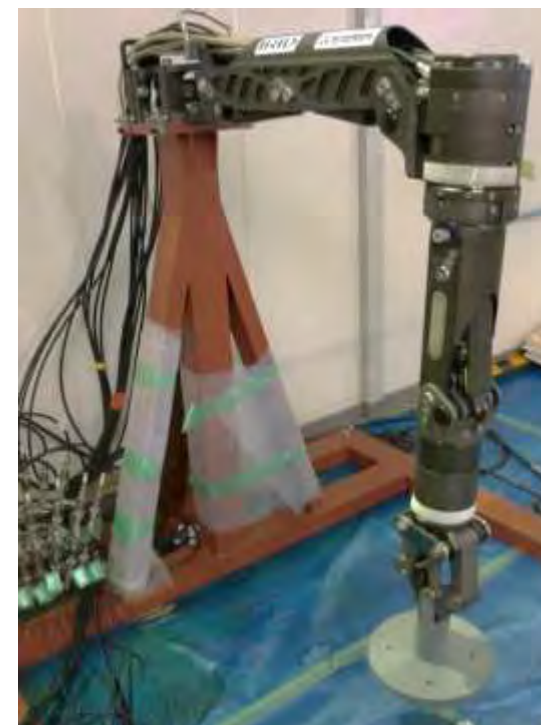

Hydraulic manipulator

6. Implementation details of this project

6.2. Implementation details

2) Development of Element Technology for Retrieval Device Installation

(2) Development of Interference Object Removal during Fuel Debris Retrieval

c. Method to remove interfering objects by the fuel debris retrieval device commonly designed for both the access methods

(iv) Development of hydraulic manipulator force control methods

- Development results

- Development of force control methods for single axis cylinder

Estimating force acting on a single axis cylinder, which the influence of gravity on can be controlled and is free from the influence of other axes, and developing control rules applicable to a single cylinder control

- Development of force estimation methods

A hydraulic system was characterized and modeled using a hydraulic system characteristics identification method.

Force generated by a cylinder was estimated using the pressure and pressure receiving area of the cylinder and a hydraulic system model. The result of the estimation coincided with the actual measurement by a force sensor with an accuracy of 90% or more.

- Development of force control methods

The effectiveness of force control methods which classic control theory (PID control) and modern control theory (H^∞) were applied to were evaluated using the estimated force.

- Establishment of a method to integrate position control and force control

In order to achieve position control and force control effectively and simultaneously, the effectiveness of two integration methods was evaluated: one is to implement both the controls in parallel, and the other implementing in series.

Cylinder

Force sensor

Press down plate
(fixed)Pressure
sensor

**Single axis hydraulic
cylinder test equipment**

6. Implementation details of this project

6.2. Implementation details

2) Development of Element Technology for Retrieval Device Installation

(2) Development of Interference Object Removal during Fuel Debris Retrieval

c. Method to remove interfering objects by the fuel debris retrieval device commonly designed for both the access methods

(iv) Development of hydraulic manipulator force control methods

- Development results
- Development of force control methods for multi-axis robot arm

· Development of force estimation methods

Torques acting on individual axes when the arm lifts a weight were estimated based on the pressure and pressure receiving area of the hydraulic cylinder of each axis and the arm joint design, and a force transmitted to the front end of the arm was estimated (calculated) using the estimated torques.

Regarding force estimation methods, a method to estimate the force of a multi-axis arm by applying knowledge obtained from the study of a single axis was found feasible.

· Development of force control methods

A PID control was implemented using the estimated force, and the method was found applicable to the force control of a multi-axis arm.

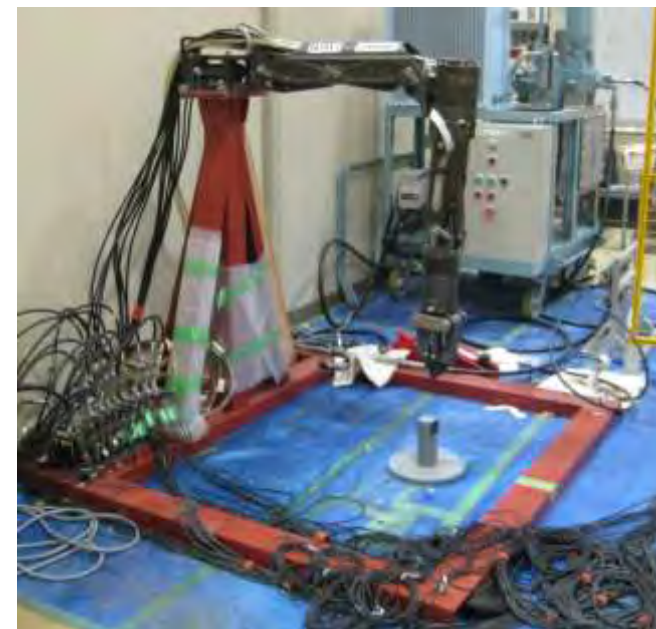

Hydraulic manipulator test equipment

6. Implementation details of this project

6.2. Implementation details

2) Development of Element Technology for Retrieval Device Installation

(2) Development of Interference Object Removal during Fuel Debris Retrieval

c. Method to remove interfering objects by the fuel debris retrieval device commonly designed for both the access methods

(iv) Development of hydraulic manipulator force control methods

- Summary of development results

- Development of force estimation and force control methods

A method to estimate the force of a single axis cylinder and a method to control its force were established.

A force estimation method and force control method applicable to a multi-axis arm were developed by applying knowledge obtained from study of a single axis cylinder, and were proved effective through the test using the hydraulic manipulator test equipment.

- No trade-off between position control and power control (Both must meet requirements.)

An integrated control method for position control and force control was established without sacrificing their performance and functions. The effectiveness of the method was confirmed with a single cylinder, and its applicability to a multi-axis arm was found to be feasible.

- Technologies and benefits brought about by the development results

- Establishment of a force estimation method and force control logic that require no force sensors

Normally force sensors such as a load cell are used for force control. Now, force control without force sensors is possible since a method to estimate force using a hydraulic pressure has been established.

Since no sensors are required, there are benefits such as the downsizing of devices and the elimination of cables.

6. Implementation details of this project

6.2. Implementation details

2) Development of Element Technology for Retrieval Device Installation

(2) Development of Interference Object Removal during Fuel Debris Retrieval

c. Method to remove interfering objects by the fuel debris retrieval device commonly designed for both the access methods

(iv) Development of hydraulic manipulator force control methods

- Issues and action policy

No.	Issues	Action policy*
1	Application of developed force estimation and force control methods to control logic used for actual operation at the site	Applying the developed force estimation method, which uses hydraulic pressure and does not use force sensors, to the design of devices used for actual operation at the site, and evaluating the applicability of the estimated force to the regulation of the end tool press down force during fuel debris opening and the contact detection of the arm tip with interference objects

*: Contents of the action policy will be discussed through future engineering activities.

6. Implementation details of this project

6.2. Implementation details

2) Development of Element Technology for Retrieval Device Installation

(2) Development of Interference Object Removal during Fuel Debris Retrieval

c. Method to remove interfering objects by the fuel debris retrieval device commonly designed for both the access methods

(v) Development of a method to plan the trajectory of a multi-degree of freedom robot that takes into consideration the prevention of interference to surroundings

● Development objectives

- Developing a method to create the best suited trajectory of a robot arm that takes into consideration the prevention of the interference of the elbow with surroundings in a narrow environment

● Issues

- Though the range of the movement of the arm in a narrow place was expanded by the introduction of a multi-degree of freedom robot (such as the access rail and robot arm integrated mechanism, or an electric manipulator with welding head), the manipulation of the robot arm to targets in a narrow place will be very difficult for operators as precision positioning is required. To cope with this challenge, the introduction of a multi-degree of freedom robot will be needed to realize the precise manipulation of the robot arm in a narrow place, and thus a method to automatically plan the trajectory of the arm that prevents interference with the surroundings needs to be developed.

● Approaches to development

- Development of a method to describe a target trajectory and constraint conditions
- Development of a general-purpose method to describe surroundings
- Test to evaluate trajectories created by the trajectory planning method

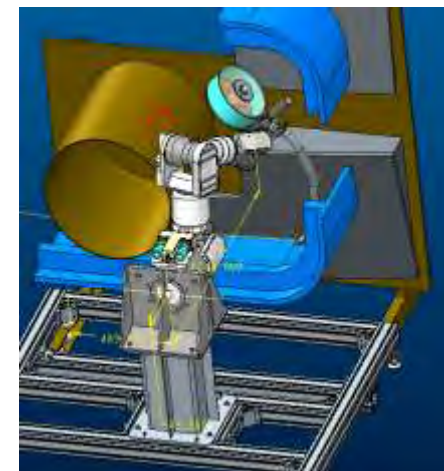

Integrated mechanism of 7-axis manipulator and 2-axis welding head

Example of narrow place access mechanism

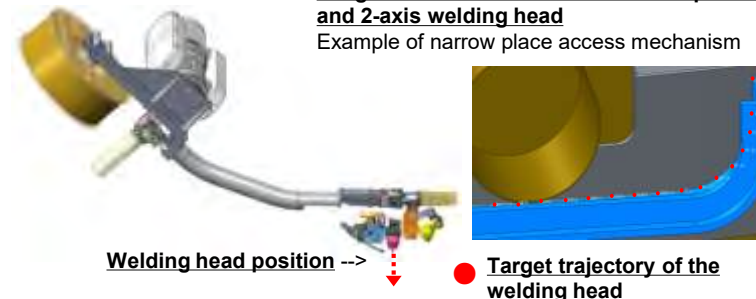

Welding head position -->

● Target trajectory of the welding head

6. Implementation details of this project

6.2. Implementation details

2) Development of Element Technology for Retrieval Device Installation

(2) Development of Interference Object Removal during Fuel Debris Retrieval

c. Method to remove interfering objects by the fuel debris retrieval device commonly designed for both the access methods

(v) Development of a method to plan the trajectory of a multi-degree of freedom robot that takes into consideration the prevention of interference to surroundings

● Development status

- In the past, trajectories in a narrow area were created by determining the angles of the joints ($\theta_1, \theta_2 \dots, \theta_n$) and the positions of the welding head that realize welding of predetermined points through teaching the manipulator a trajectory that could prevent the interference of its elbow with surroundings.

Conventional trajectory creation methods required a very long time working at the site since it relied on a trial-and-error process (several days).



● Target positions of the welding head

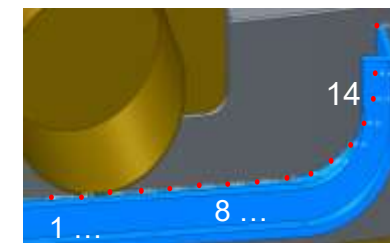

- Development of a trajectory planning method (calculation algorithm)

It was decided to take an approach to define the trajectory of a welding head to achieve a given welding task as a series of discrete positions of the head. Then, the following constraint conditions were set, and a joint angle calculation method (calculation algorithm) that could minimize the deviation from the constraint condition at each time point was developed.

Position matching constraint: The welding head of the manipulator must aim at the target welding points accurately.

Interference prevention constraint: The manipulator (its elbow) must not interfere with surroundings at any time.

6. Implementation details of this project

6.2. Implementation details

2) Development of Element Technology for Retrieval Device Installation

(2) Development of Interference Object Removal during Fuel Debris Retrieval

c. Method to remove interfering objects by the fuel debris retrieval device commonly designed for both the access methods

(v) Development of a method to plan the trajectory of a multi-degree of freedom robot that takes into consideration the prevention of interference to surroundings

● Development status

- It was found that a suitable trajectory might not be obtained if given initial values were irrelevant, especially when the shape of a work target portion was complex like the one in this study. (Figure on the left below)
- As a solution, a method to automatically plan a trajectory that could prevent interference with surroundings was able to be developed by adding the following procedure: the trajectory planner instructs the position of the arm at multiple important points along the required continuous trajectories (from Section 1, 2) to 3) in advance.
- It was demonstrated that the creation of an initial design of a trajectory for a manipulator that could prevent interference and the adjustment of the initial design at the site could be simplified by this method and only giving the start and intermediate points of the welding work.

Required trajectory

Section 1) -> Section 2) -> Section 3)

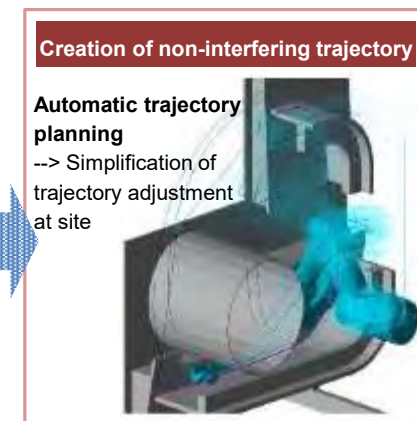
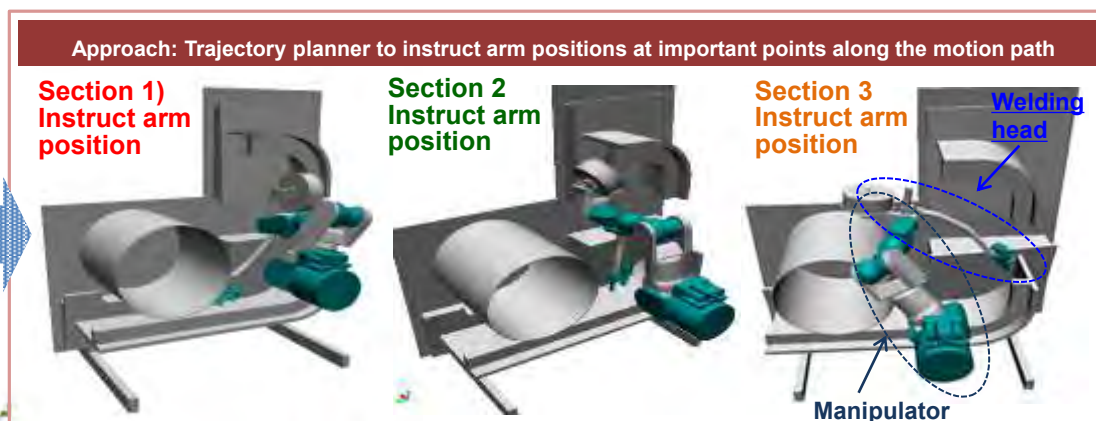
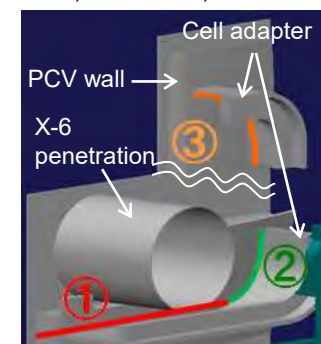

6. Implementation details of this project

6.2. Implementation details

2) Development of Element Technology for Retrieval Device Installation

(2) Development of Interference Object Removal during Fuel Debris Retrieval

c. Method to remove interfering objects by the fuel debris retrieval device commonly designed for both the access methods

(v) Development of a method to plan the trajectory of a multi-degree of freedom robot that takes into consideration the prevention of interference to surroundings

● Achievements

➤ **Method to create the most appropriate interference preventing trajectory**

- Normally, the position of a manipulator and the position of the front end of a manipulator, or the like, are determined by teaching at the site prior to the operation. However, teaching is difficult for remote control and work in a narrow place.
- In addition, it will be a heavy burden for the operator of a manipulator to manipulate its front end by remote control to targets in a narrow place, whose conditions dynamically change with the progress of the operation, while getting through interfering objects.
- This method will enable the planning of the position of a manipulator and the position of the front end of a manipulator or the like by giving a target trajectory and constraint conditions (position matching constraint and interference prevention constraint) and reduce the operator's burden.
- It will also reduce workload at the site since the plan of the position of a manipulator and the position of the front end of a manipulator or the like can be easily adjusted by modifying the target trajectory and constraint conditions.

6. Implementation details of this project

6.2. Implementation details

2) Development of Element Technology for Retrieval Device Installation

(2) Development of Interference Object Removal during Fuel Debris Retrieval

c. Method to remove interfering objects by the fuel debris retrieval device commonly designed for both the access methods

(v) Development of a method to plan the trajectory of a multi-degree of freedom robot that takes into consideration the prevention of interference to surroundings

● Issues and action policy

No.	Issues	Action policy*
1	<p>Prevention of the interference of a multi-degree of freedom robot with surroundings during its operation</p> <p>Though operators' workload was reduced by this development, such as robot teaching work, it is conceivable that operators will consume a lot of time in the operation of the robot arms since the condition of the inside of the PCV will change dynamically with the progress of fuel debris removal operation.</p>	<p>Development of a map that displays the surroundings of a manipulator for its operator in an easy-to-understand way, including relative position between the arm and its surroundings and risk of interference</p> <p>Development of an automatic interference prevention control between the arm and its surroundings</p>

*: Actions described below will be implemented in the following fiscal year or later.

6. Implementation details of this project

6.2. Implementation details

1) Development of Technology for Prevention of Fuel Debris Spreading

(1) Development of Fuel Debris Collection System

(2) Development of Fuel Debris Cutting / Dust Collection System

(3) Development of Prevention Method of Fuel Debris Spreading

2) Development of Element Technology for Retrieval Device Installation

(1) Development of Element Technology for Work Cells

(2) Development of Interference Object Removal during Fuel Debris Retrieval

3) Development of Remote Maintenance Technology for Fuel Debris Retrieval Device

6. Implementation details of this project

6.2. Implementation details

3) Development of Remote Maintenance Technology for Fuel Debris Retrieval Device

(1) Development of remote maintenance policies applicable to both the top and side access methods

Components and equipment used for fuel debris retrieval (e.g., fuel debris cutting and collecting system, shipping containers, work benches, monitoring equipment, and robot arms that handle fuel debris) are installed in a high-radiation area. For this reason, in principle, maintenance must be carried out remotely. This requires ideas on methods of maintenance regarding components and equipment suited for handling fuel debris to be reviewed and maintenance methods that are in line with such ideas to be studied. In addition, feasibility evaluation, identification of issues, and rational action policy for actual operation will be studied.

Among other things, the following shall be included in the main development themes and element tests will be performed on an as needed basis. Through these activities, issues will be identified and reviewed.

a. Development of remote maintenance policies applicable to both the top and side access methods

- Regarding the top access method, the basic policies were developed, focusing on the developed storage canister transfer system, to aim at formulating rational remote maintenance policies.
- As to the side access method, basic conditions concerning maintenance work are under discussion and coordination. Basic policies on remote maintenance were formulated taking into consideration accessibility by workers and their exposure during maintenance work.

b. Layout and traffic lines of main devices and equipment used in the top and side access methods

- Regarding the top access method, the basic remote maintenance policies were developed based on the layout of main devices and equipment of the storage canister transfer system.
- As to the side access method, design conditions for cells and method design are under discussion and coordination. The first-phase review was implemented on three side access methods by the hot cell manipulator working group. Basic policies on the layout and traffic lines of main devices and equipment were formulated taking into consideration the future usability of fuel debris and interference object removal devices and equipment.

c. Development of technology development plan

- Based on the results of above-mentioned activities, issues to be addressed regarding the maintenance of the fuel debris retrieval device were identified, and a development plan to address the identified issues was formulated with the aim to realizing the fuel debris retrieval.

6. Implementation details of this project

6.2. Implementation details

3) Development of Remote Maintenance Technology for Fuel Debris Retrieval Device

(1) Development of remote maintenance policies applicable to both the top and side access methods

- Purpose of development
 - Ensuring a coherent policy for the maintenance and proving the feasibility of the policy as a systematic maintenance framework
- Issues to be solved
 - Though maintenance plans have been developed for some devices and equipment, there is no unified concept of how it should be in them (such as which to choose: remote or manual site work, where maintenance is to be implemented, and what maintenance equipment is to be used). Thus, a systematic maintenance framework has not been established.
 - From the above point of view, the rationality of the current configuration and layout of devices and equipment is questionable.
- Approaches to development
 - Developing basic maintenance policies for the 1st floor (as to which to choose: remote or manual site work and where maintenance is to be implemented) as the approaches to maintenance
 - Determining areas workers can enter
 - Classifying maintenance work into those which can be done remotely and those which cannot
 - Designing the layout of devices and equipment in the operation floor and maintenance building that takes into consideration maintenance work (layout design)
 - Developing necessary technologies (The goal of this project is to formulate a development plan.)
- Expected outcome
 - Basic maintenance policies for equipment in the cells (idea)
 - Area classification by workers' authorized level
 - Maintenance classification, etc.
 - Operation floor/maintenance building equipment layout design
 - Technology development plan

(Development flow)

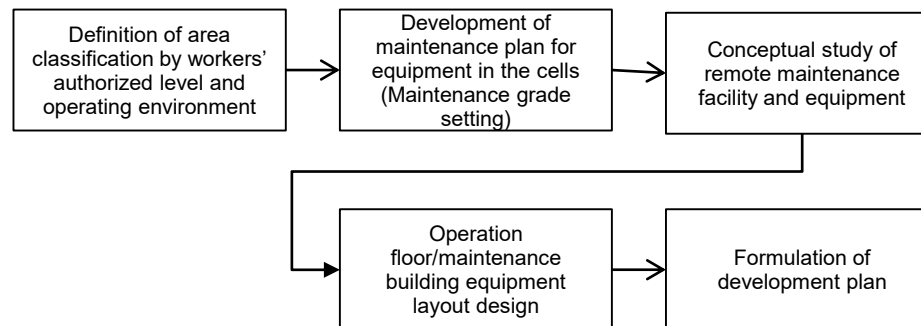

6. Implementation details of this project

6.2. Implementation details

3) Development of Remote Maintenance Technology for Fuel Debris Retrieval Device

(1) Development of remote maintenance policies applicable to both the top and side access methods

Definition of use conditions of equipment in the 1st floor

[Area classification by workers' authorized level (draft) and operating environment]

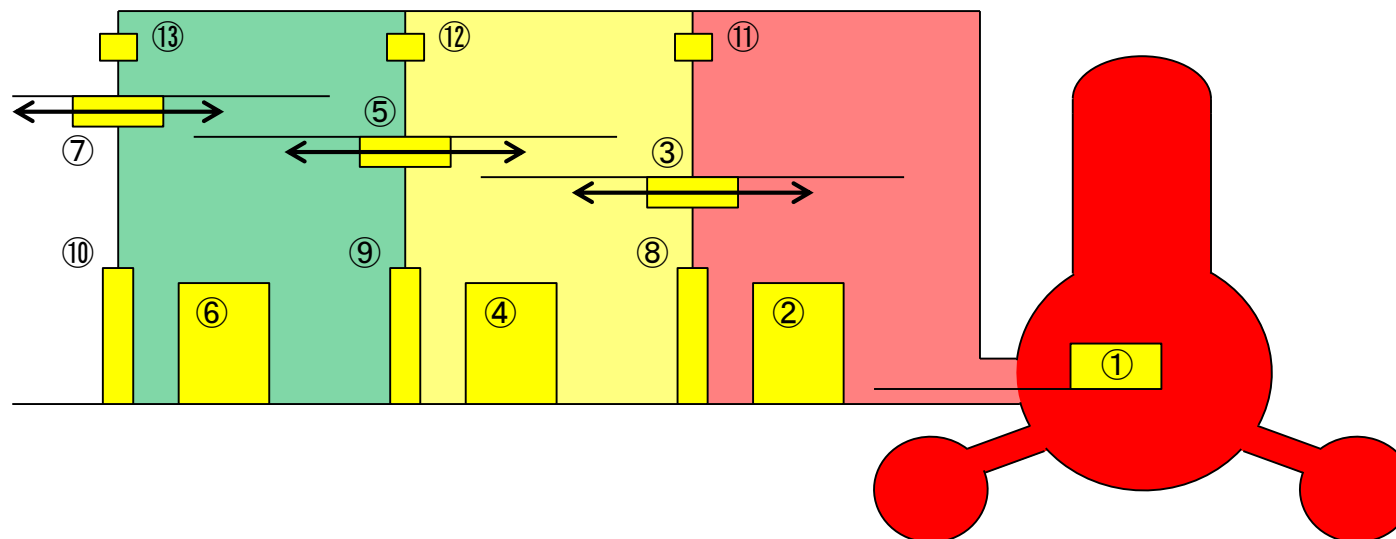

- Low contamination area:
Workers are allowed to enter and stay for a short time in normal circumstances
- Medium contamination area:
Workers are allowed to enter and stay for a short time only in case of emergency
- High contamination area: Workers are not allowed to enter at any time including emergency. However, a method to have workers enter this area safely needs to be provided to prepare for an unavoidable situation.
- High contamination area:
Workers must not enter this area without exception including emergency
- Equipment that requires maintenance (see the list on the right)

Example of equipment that requires maintenance

- ① Equipment used in the PCV
- ② Equipment permanently installed in the red cell
- ③ Equipment to handle transportation between the red cell and yellow cell
- ④ Equipment permanently installed in the yellow cell
- ⑤ Equipment to handle transportation between the yellow cell and green cell
- ⑥ Equipment permanently installed in the green cell
- ⑦ Equipment to handle transportation between the green cell and the outside the cell
- ⑧ Door between the red cell and yellow cell
- ⑨ Door between the yellow cell and green cell
- ⑩ Door between the green cell and outside the cell
- ⑪ Communicating passage between the red cell and yellow cell
- ⑫ Communicating passage between the yellow cell and green cell
- ⑬ Communicating passage between the green cell and outside the cell

6. Implementation details of this project

6.2. Implementation details

3) Development of Remote Maintenance Technology for Fuel Debris Retrieval Device

(1) Development of remote maintenance policies applicable to both the top and side access methods

A maintenance grade was assigned to each equipment group according to their use conditions and the availability of decontamination. [Equipment use areas and maintenance grades]

Equipment use area	Type of equipment		Approach to maintenance	Maintenance grade
High contamination area (Red marked area)	1)	Equipment used in the PCV	Performing maintenance in the high contamination area by remote control	1
			Moving equipment to a maintenance facility by remote transportation means and performing maintenance	3
	2)	Equipment permanently installed in the red cell	Performing maintenance in the high contamination area by remote control	1
			Moving equipment to a maintenance facility by remote transportation means and performing maintenance	3
	3)	Equipment to handle transportation between the red cell and yellow cell	Moving equipment to a medium contamination area and performing maintenance there by remote control if the source can be removed and the equipment can be decontaminated by remote control	2
			Moving equipment to a maintenance facility by remote transportation means and performing maintenance	3
8)	Door between the red cell and yellow cell	Performing maintenance in a medium contamination area by remote control	2	
Medium contamination area (Yellow marked area)	4)	Equipment permanently installed in the yellow cell	Performing maintenance in a medium contamination area by remote control	2
			Moving equipment to a maintenance facility by remote transportation means and performing maintenance	3
	5)	Equipment to handle transportation between the yellow cell and green cell	Moving equipment to a low contamination area and performing maintenance there by manual work if the source can be removed and the equipment can be decontaminated by remote control	4
	9)	Door between the yellow cell and green cell	Performing maintenance in a low contamination area by manual work	4
Low contamination area (Green marked area)	6)	Equipment permanently installed in the green cell	Performing maintenance in a low contamination area by manual work	4
	7)	Equipment to handle transportation between the green cell and outside the cell	Performing maintenance by manual work outside the cell	4
	10)	Door between the green cell and outside the cell	Performing maintenance by manual work outside the cell	4

6. Implementation details of this project

6.2. Implementation details

3) Development of Remote Maintenance Technology for Fuel Debris Retrieval Device

(1) Development of remote maintenance policies applicable to both the top and side access methods

Maintenance methods according the area classification by workers' authorized level (draft) are defined as maintenance grades.

[Relationship between maintenance grades and choice of remote/manual site maintenance]

Maintenance grade	Maintenance method in normal circumstances	Area to perform maintenance in	Use area of equipment for which maintenance is performed	Notes
1	Remote maintenance	High contamination area	High contamination area (Red marked area)	
2	Remote maintenance	Medium contamination area	High contamination area (Red marked area)	The level of difficulty is below Maintenance Grade 1 since workers are allowed to enter and stay for a short time in case of emergency. It is allowed only when radiation source can be removed and the equipment can be decontaminated by remote control. The maintenance grade is elevated to Grade 1 unless these conditions are met.
			Medium contamination area (Yellow marked area)	The level of difficulty is below Maintenance Grade 1 since workers are allowed to enter and stay for a short time in case of emergency.
3	Remote or manual site work	Maintenance facility	High contamination area (Red marked area)	It is allowed only when contaminants adhering to the equipment and components can be sealed into a sealing container by remote control for transportation. The maintenance grade is elevated to Grade 1 unless these conditions are met.
			Medium contamination area (Yellow marked area)	It is allowed only when contaminants adhering to the equipment and components can be sealed into a sealing container by remote control for transportation. The maintenance grade is elevated to Grade 2 unless these conditions are met.
4	Manual site maintenance	Low contamination area	Medium contamination area (Yellow marked area)	It is allowed only when radiation source can be removed and the equipment can be decontaminated by remote control. The maintenance grade is elevated to Grade 2 unless these conditions are met.
			Low contamination area (green marked area)	
—	Discarding	—	—	Consumables, etc. Note that discarding work should be done either by remote control or by manual site work according to the classification of the area to do discarding work in.
—	No maintenance required	—	—	Structural materials with no risks of aged deterioration and failure

6. Implementation details of this project

6.2. Implementation details

3) Development of Remote Maintenance Technology for Fuel Debris Retrieval Device

(1) Development of remote maintenance policies applicable to both the top and side access methods

Listing equipment in the cells and determining a maintenance grade for each of them

[Development of maintenance plan for equipment in the cells: Equipment list]

Equipment in the cells will have to be designed in detail by the engineering team toward actual operation at the site. It is necessary to provide information about maintenance methods and procedures for each equipment to them. An exemplary list that summarizes such information is shown below.

Listing all equipment in the cells and scrutinizing components and parts that require maintenance for each of them

List of equipment in the cells

Installation place	Equipment name	Number of unit	Type/model	Maintenance method (by unit/by component)	Contamination level	Decontamination availability	Maintenance grade	Normal maintenance method	Where to do maintenance	Maintenance policy	Maintenance procedures	Consumables Reserve parts	Notes
C4H*	Storage canister transferring jib crane 1	2	Jib crane with weight measurement function	1) Hoist 2) Cable bear 3) Swivel device 4) Flexible cable 5) Boom and bearing	High	Difficult	3	Manual site maintenance or unit change	Maintenance facility	Disassemble by power manipulator or the like, move to a maintenance facility and do maintenance there.	According to the regular self-inspection set forth by the Safety Ordinance for Cranes, etc.	2) Cable bear 4) Flexible cable	

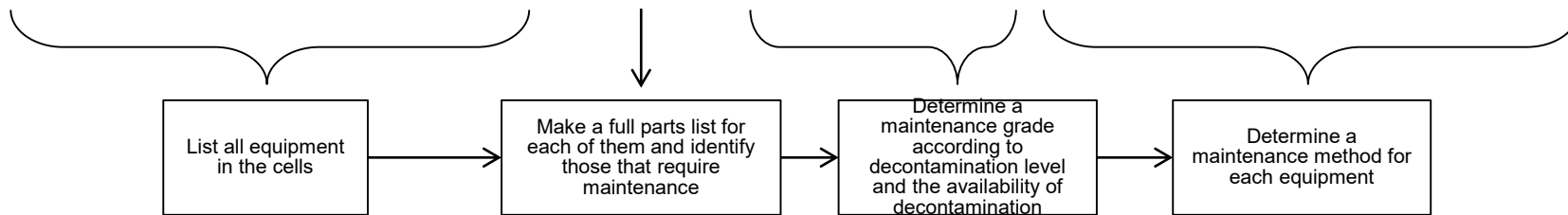

* C4H: One of area classification by contamination level. C4 means an area where there is equipment that may cause serious harm due to leakage. H indicates high contamination.

6. Implementation details of this project

6.2. Implementation details

3) Development of Remote Maintenance Technology for Fuel Debris Retrieval Device

(1) Development of remote maintenance policies applicable to both the top and side access methods

Conceptual study of remote maintenance facility and equipment
[Development of maintenance plan for equipment in the cells: Maintenance concept study]

Dividing components of equipment in the cells for each unit that will be required for maintenance
(Continued to the next page)

No.390

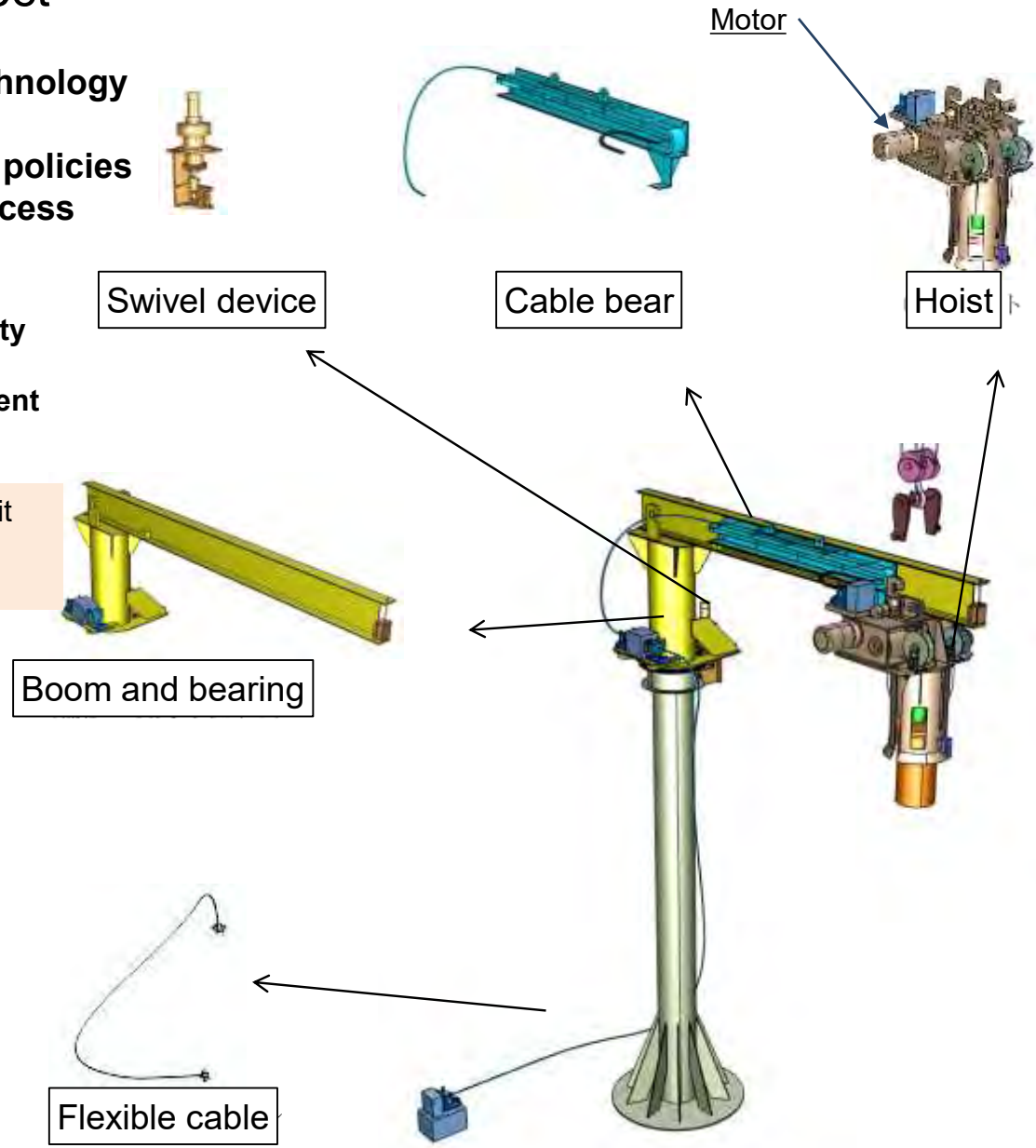

6. Implementation details of this project

6.2. Implementation details

3) Development of Remote Maintenance Technology for Fuel Debris Retrieval Device

(1) Development of remote maintenance policies applicable to both the top and side access methods

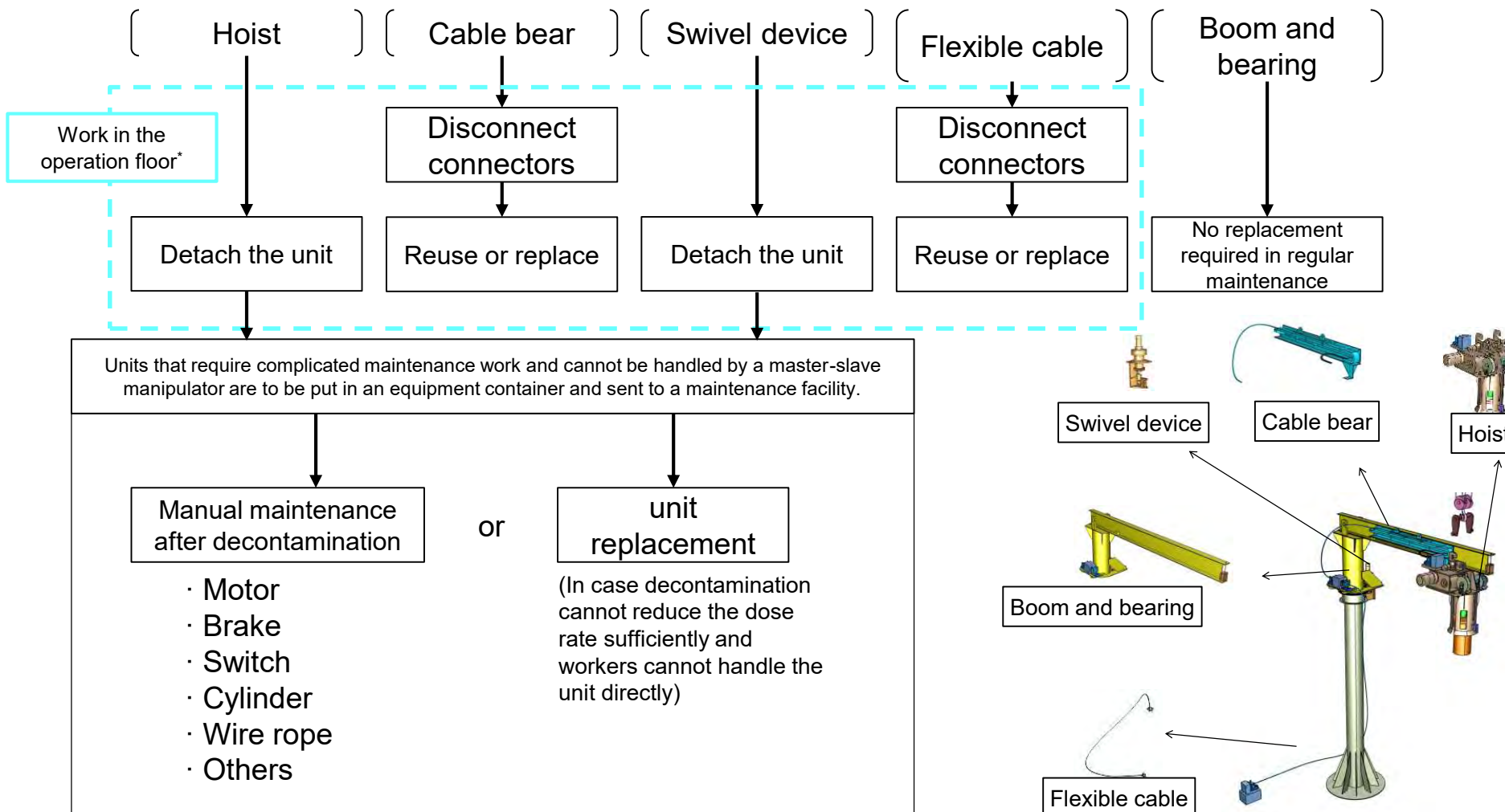

*: Since workers are not allowed to enter the cells, the use of a "master-slave manipulator" or the like is supposed for work in the operation floor.

Maintenance flow of the storage canister transferring jib crane (Example)

6. Implementation details of this project

6.2. Implementation details

3) Development of Remote Maintenance Technology for Fuel Debris Retrieval Device

(1) Development of remote maintenance policies applicable to both the top and side access methods

Operation floor/maintenance building layout design

[Maintenance work space design]

Determine the dimensions of equipment containers to be handled based on the dimensions of units accommodated in them

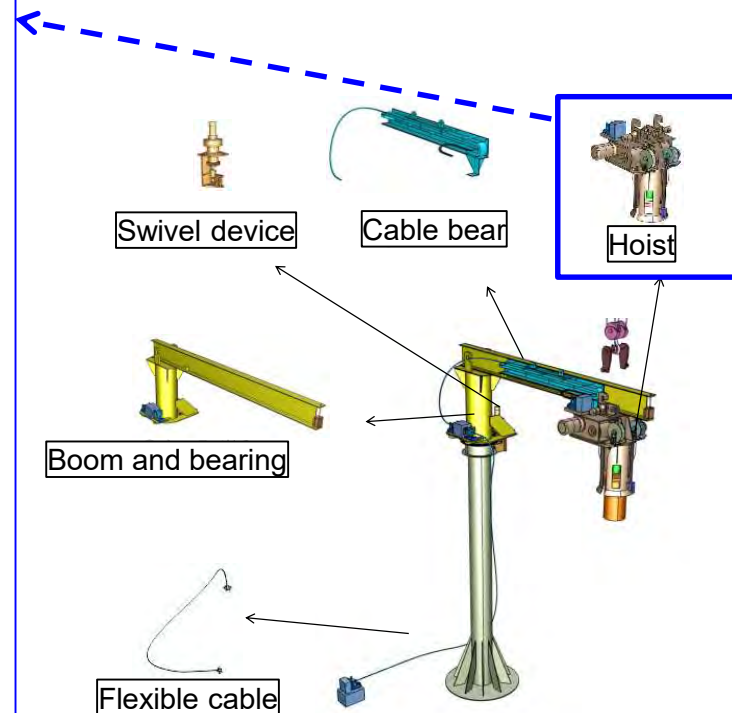
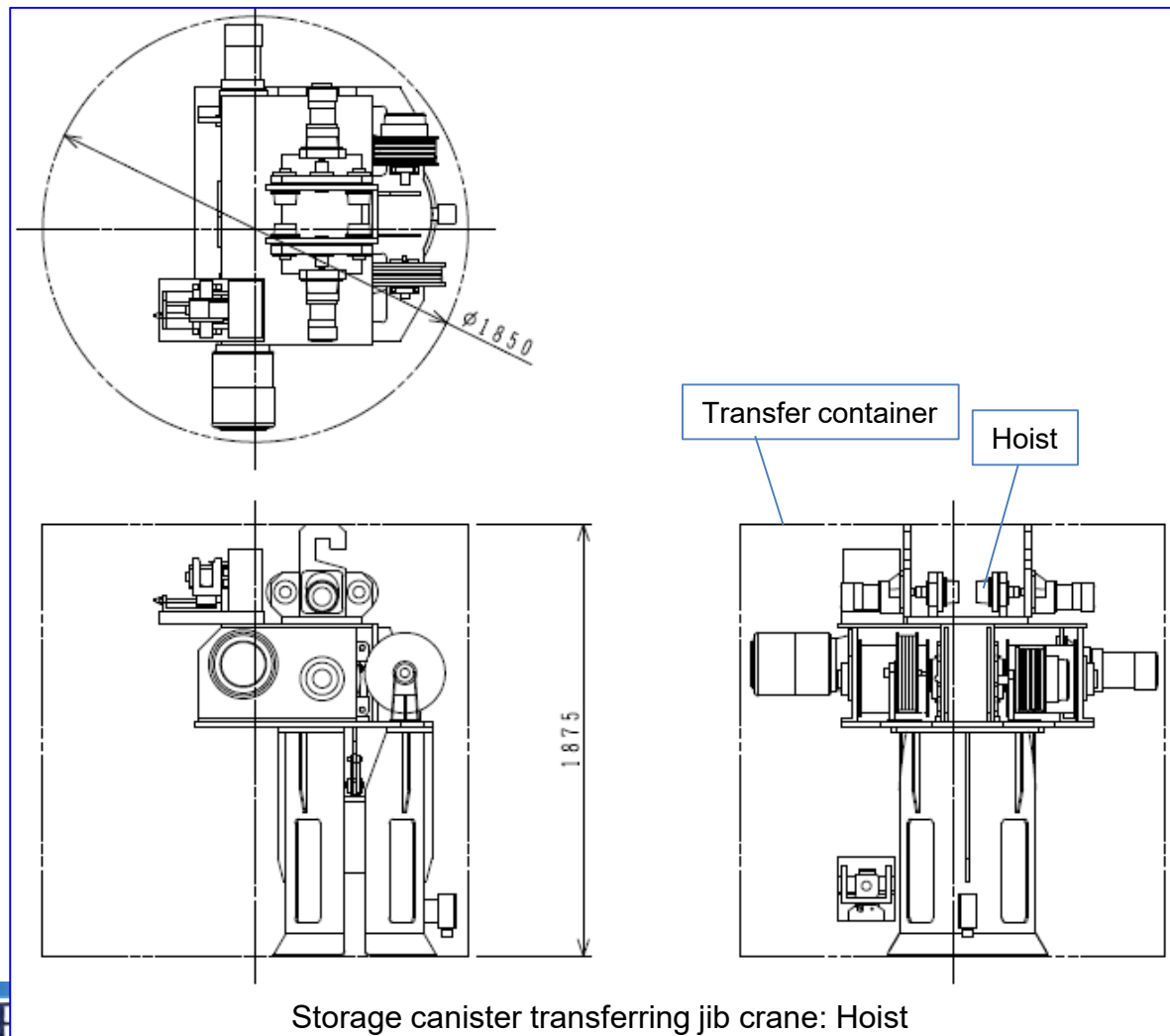

Storage canister transferring jib crane: Hoist

6. Implementation details of this project

6.2. Implementation details

3) Development of Remote Maintenance Technology for Fuel Debris Retrieval Device

(2) Layout and traffic lines of main devices and equipment used in the top and side access methods

Operation floor/maintenance building layout design

[Operation floor layout design]

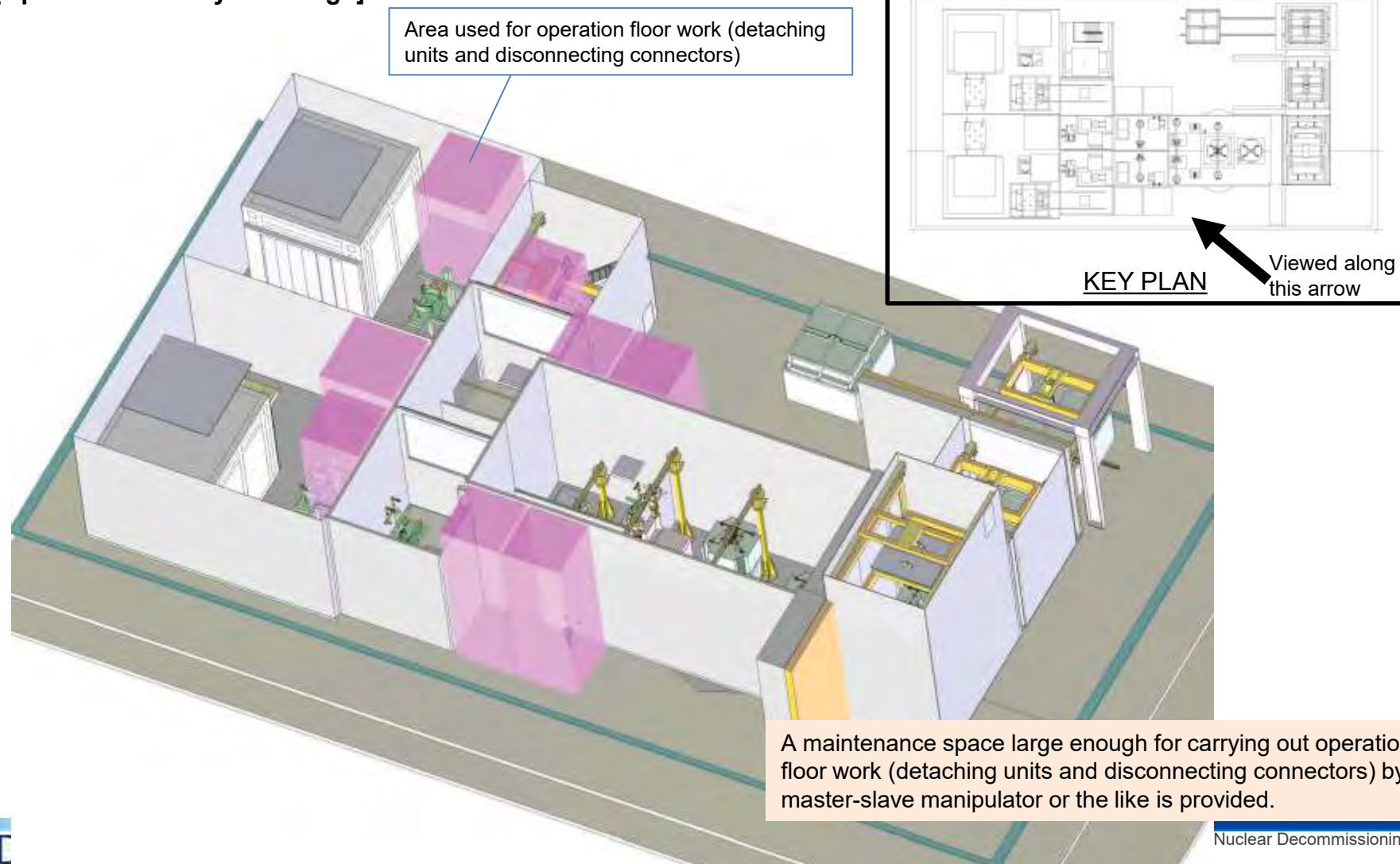

6. Implementation details of this project

6.2. Implementation details

3) Development of Remote Maintenance Technology for Fuel Debris Retrieval Device

(2) Layout and traffic lines of main devices and equipment used in the top and side access methods

Operation floor/maintenance building layout design [Maintenance building layout design]

- The draft of the maintenance building layout was designed based on maintenance work planned in it.
- A shipping/receiving preparation room, decontamination room, and dismantling room are provided in the maintenance building from the viewpoints of the prevention of radioactive material dispersion and decontamination. (Maintenance is performed in the dismantling room.)

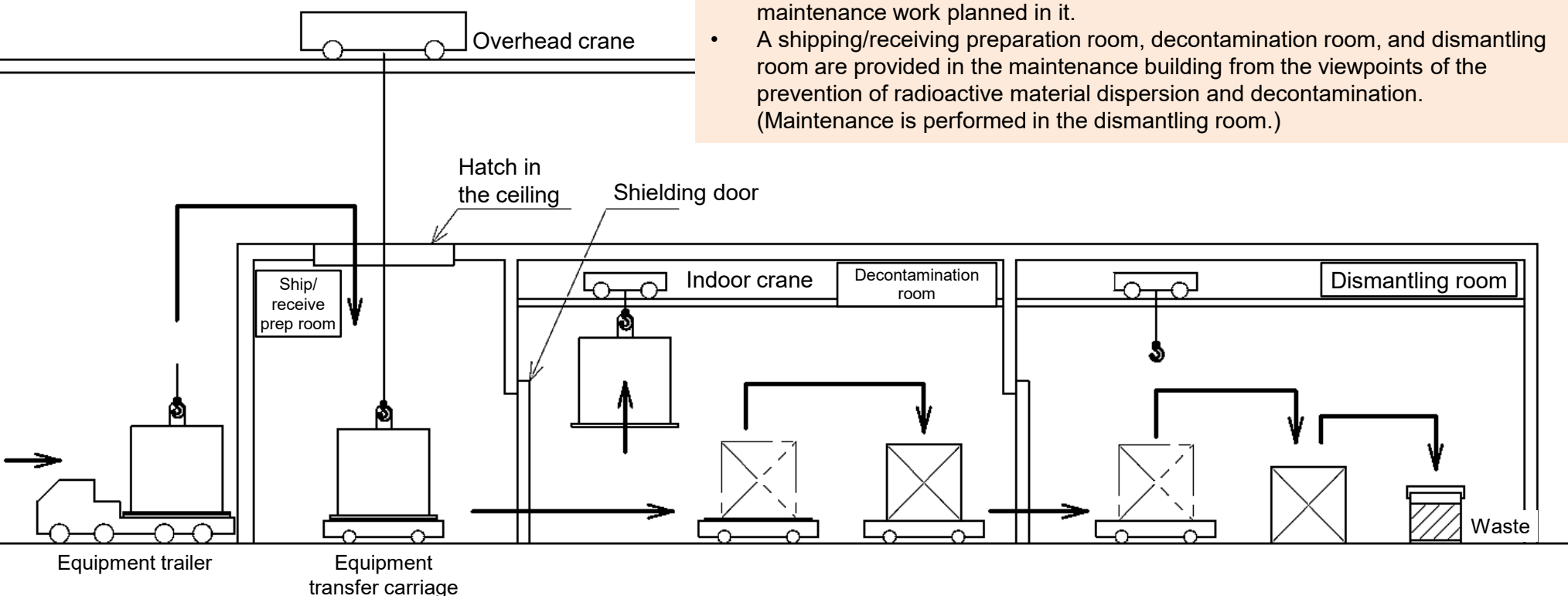

- Move the equipment to be maintained from the reactor building using a container.

- Receive the container.

- Open the container.
- Check the equipment surface contamination and decontaminate it.
- Move the equipment to the dismantling room.

- Equipment teardown and inspection
- Greasing and part replacement
- Reassembly, adjustment, and retightening bolts
- Integrity check after inspection

Flow chart of equipment transportation in the maintenance building (Draft)

6. Implementation details of this project

6.2. Implementation details

3) Development of Remote Maintenance Technology for Fuel Debris Retrieval Device

(2) Layout and traffic lines of main devices and equipment used in the top and side access methods

Operation floor/maintenance building layout design

[Maintenance building layout design]

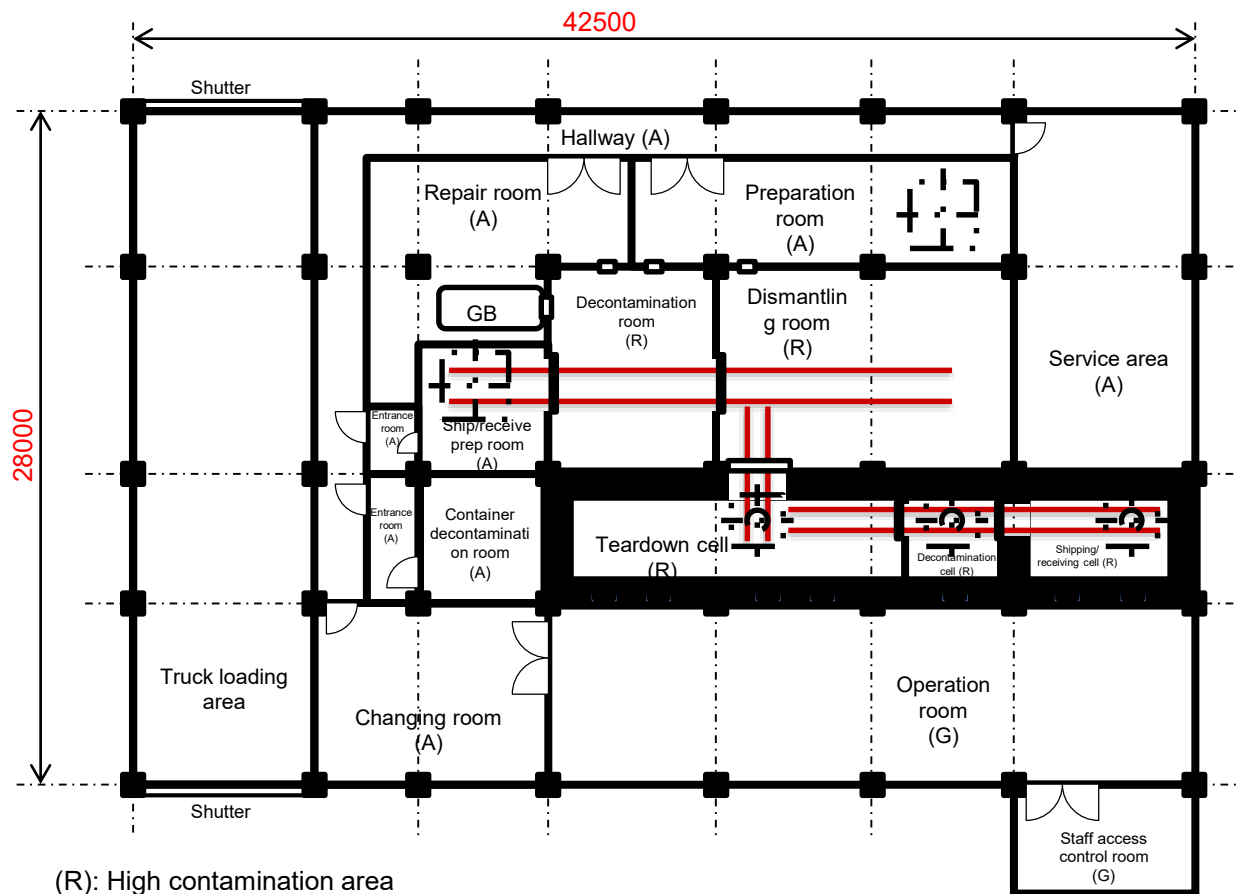

(R): High contamination area
 (A): Medium contamination area
 (G): Low contamination area

- (Functions of the rooms and areas)
- Truck loading area: Shipping/receiving containers
 - Decontamination room: Pulling out equipment from the container and decontaminating it
 - Dismantling room: Performing maintenance of general equipment and testing operation after maintenance
 - Repair room: Performing time-consuming maintenance of precision equipment
 - Service area: Storage for reserve parts and empty containers

Rooms and areas large enough to handle estimated sizes of equipment and containers and their traffic line are provided in the maintenance building.

6. Implementation details of this project

6.2. Implementation details

3) Development of Remote Maintenance Technology for Fuel Debris Retrieval Device

(3) Formulation of technology development plan

- All technical issues identified through the above-mentioned activities were listed for action planning.
- It is time to design devices and equipment used for actual operation at the site in detail, taking into consideration various factors such as use environment, operating conditions, and interface with other devices. Effective measures need to be developed to solve all the issues.

Item	Issues	Concrete actions
Maintenance plan for equipment in the cells	Assurance of the reproducibility of the position of position detecting switches after teardown and reassembly	Said reproducibility after teardown and reassembly remains as an issue. Equipment design that can eliminate precise adjustment in the cells needs to be developed for all equipment.
Remote maintenance of the equipment container washing and drying machine	Design of best-suited connectors and couplers	Connectors and couplers need to be connected and disconnected remotely by a manipulator. Wire, cable, and pipe connection design that can be handled by remote control need to be developed by combining and arranging connectors. Based on this, remote maintenance procedures need to be established.
Conceptual study of remote maintenance facility and equipment	Equipment container design	There is a risk of equipment damaged by an overturn or fall accident during transportation. Such accident may be caused by the unique shape or eccentricity of the center of gravity of the equipment. Measures to prevent such accident needs to be devised for the equipment container.
Equipment layout inside and outside the cell	Transportation between the reactor building and maintenance building	Transportation of equipment containers: where to decontaminate the surface of the container, specific measures to prevent the dispersion of contaminants, and operation in the rain
Maintainability of cranes in CH4 cells*	Design of interface with access devices and the development of contamination spread prevention measures	The cranes need to be designed so that they can be decontaminated easily and don't pose a high risk of exposure to workers during maintenance.
Detailed design of equipment decontamination and contamination measurement procedures	Detailed design of decontamination and contamination measurement operation	Remote decontamination and contamination measurement procedures that require no disassembly into small parts need to be designed in detail.

* C4H: One of area classifications by contamination level. C4 means an area where there is equipment that may cause serious harm due to leakage. H indicates high contamination.

7. Summary

1) Development of Technology for Prevention of Fuel Debris Spreading

(1) Development of Fuel Debris Collection System

- Technical information on powder fuel debris retrieval system was collected and organized by assuming the process of retrieving fuel debris in the PCV bottom.
- Technical information was collected and organized on tools used to collect dug out fuel debris and pebble-like fuel debris effectively.

(2) Development of Fuel Debris Cutting / Dust Collection System

- Effective methods to cut, remove and collect fuel debris were studied and organized based on information about where and how fuel debris to be dug out and collected possibly lie.
- Cutting performance evaluation tests were performed on chisel cutting and ultrasonic core boring using MCCl simulant specimens, and cutting characteristics and cutting speeds were obtained.
- The component of fuel debris in a form of MCCl product and a method to prototype a fuel debris simulant specimen were studied. In addition, the actual prototype of the fuel debris simulant specimen was subjected to a cutting test, and cutting wastewater from the test was sampled and analyzed to obtain data such as particle size distribution.

(3) Development of Prevention Method of Fuel Debris Spreading

- Element tests were performed with the aim of developing a method and procedure to build a dike in the PCV to prevent the spread of fuel debris in the PCV bottom to vent pipes, suppression chambers (S/C) and other sections by fuel debris retrieval operation. The result of the element tests showed the feasibility of the construction of such dikes by remote operation.

2) Development of Element Technology for Retrieval Device Installation

(1) Development of Element Technology for Work Cells

- Technologies applicable to the sealing of the cell and the connection between the cell and PCV were compared and organized.
- Inflate seals are planned to be used to seal the gap of the joint between the cell and PCV. Element tests were performed to evaluate the feasibility of inflate seal installation procedures and work steps, and issues associated with the installation were identified.

2) Development of Element Technology for Retrieval Device Installation (Continued)

(2) Development of Interference Object Removal during Fuel Debris Retrieval

- **Material removal methods applicable to the removal of interfering objects that lie in the planned access route to fuel debris in the PCV bottom, by way of the Partial submersion-Side access method, were studied and organized.**
- **Based on information collected and organized on interfering objects, element tests were performed with the aim of evaluating the feasibility of removal methods and work steps and identifying issues associated with the removal operation.**
- **Element tests were performed to develop and evaluate the method to remove interfering objects in the reactor bottom by way of the Partial submersion-Top access method. As a result, a basic cutting method and cut piece collection method applicable to interfering objects in the reactor bottom such as CRD.H was developed and demonstrated.**
- **Element tests were performed to develop and evaluate the method to remove interfering objects in and outside the pedestal by way of the Partial submersion-Side access method. As a result, a basic cutting method and cut piece collection method applicable to narrow places in and outside the pedestal was developed and estimated feasible.**
- **Element tests were performed to evaluate the performance of the robot arm and access rail combined system, and issues were identified. The feasibility of the basic operations of the combined system required for fuel debris/interfering object removal was demonstrated.**

3) Development of Remote Maintenance Technology for Fuel Debris Retrieval Device

- **Basic policies of remote maintenance were studied on equipment in the cells built for the Partial submersion-Side access method as an example, and maintenance classifications and maintenance equipment and facility were proposed.**

8. Specific Objectives for Achieving the Purposes of Technological Developments

No.399

1) Development of Technology for Prevention of Fuel Debris Spreading	
(1) Development of Fuel Debris Collection System	Methods, equipment, and systems to process, collect and transport various forms of fuel debris (such as rubble, sludge, and powder), including the system to put collected fuel debris in a storage canister and transfer it out of the PVC, shall have been studied along with element tests associated with said study. Through said study, fuel debris collection, transfer methods and work steps to embody the method shall have been made clear. (TRL at the end of the project: Level 3)
(2) Development of Fuel Debris Cutting / Dust Collection System - Cutting and grinding element test	The basic performance of the selected cutting technologies shall have been demonstrated by element tests. As to the technologies on which study is continued from, the Fundamental Technologies Development Project in last fiscal year, identified issues that shall have been improved. The performance of the dust collection technology that is planned to be used along with cutting operation shall have been verified by dust collection tests. (TRL at the end of the project: Level 3)
- Element test on crushing by chisel	The performance of the selected chisel to crush fuel debris shall have been tested with mainly specimens that simulate fuel debris in the PCV bottom, and its basic performance shall have been demonstrated. In addition, the performance of the selected dust collection technology shall have been verified by dust collection tests. (TRL at the end of the project: Level 3)
- Ultrasonic core boring	The applicability of the ultrasonic core boring to fuel debris removal operation shall have been evaluated. If it was determined to be applicable, opening tests shall have been completed with fuel debris simulant specimens, and data of workability, amount of generated dust, and particle size distribution of dust shall have been obtained. (TRL at the end of the project: Level 3)
(3) Development of Prevention Method of Fuel Debris Spreading - Element test on prevention of spread through jet deflectors	The feasibility of the technology to prevent fuel debris spreading through the jet deflectors shall have been demonstrated by element tests. (TRL at the end of the project: Level 3)

8. Specific Objectives for Achieving the Purposes of Technological Developments

No.400

2) Development of Element Technology for Retrieval Device Installation	
(1) Development of Element Technology for Work Cells - Study of structure and installation method	Conceptual study shall have been completed on the installability and handleability of work cells. Based on the result, an effective remote installation method shall have been suggested for the cells. Issues associated with the realization of the method shall have been identified and approaches to address the issues shall have been made clear. (TRL at the end of the project: Level 3)
- Element test on inflate seal	The applicability of inflate seal as a boundary shall have been evaluated. If it was determined to be applicable, element tests to evaluate its sealing efficiency shall have been completed. In addition, element tests to evaluate the feasibility of inflate seal replacement by remote control shall have been completed, and the feasibility shall have been demonstrated. (TRL at the end of the project: Level 4)
(2) Development of Interference Object Removal during Fuel Debris Retrieval	Remote interfering object removal method that is required to establish access routes to fuel debris shall have been studied along with element tests associated with said study, and effective procedures, methods, equipment, and devices necessary to realize the method shall have been suggested. Issues associated with the realization of the suggested methods and equipment shall have been identified and approaches to address the issues shall have been made clear. (TRL at the end of the project: Level 3)
- Interfering objects during accessing from the top (dryer, separator, etc.)	The basic method and procedure of interfering object removal operation shall have been proved to be feasible through tests with full-scale interfering object simulants. (TRL at the end of the project: Level 4)
- Interfering objects during accessing from the side (Equipment outside the pedestal)	The basic method and procedure of interfering object removal operation shall have been proved to be feasible through tests with full-scale interfering object simulants. (TRL at the end of the project: Level 4)

8. Specific Objectives for Achieving the Purposes of Technological Developments No.401

2) Development of Element Technology for Retrieval Device Installation	
<ul style="list-style-type: none"> Structures in the reactor building (PCV wall opening) 	<p>The basic method and procedure of interfering object removal operation shall have been proved to be feasible through tests with full-scale interfering object simulants. (TRL at the end of the project: Level 4)</p>
<ul style="list-style-type: none"> Interfering objects in both the top and side access access routes (Reactor bottom, equipment in the pedestal) 	<p>The basic method and procedure of interfering object removal operation shall have been proved to be feasible through tests with full-scale interfering object simulants. (TRL at the end of the project: Level 4)</p>
<ul style="list-style-type: none"> Evaluation of the operational performance of the robot arm and access rail combined system 	<p>Various operating modes of the robot arm and access rail combined system that will be required to realize fuel debris and interfering object removal operation shall have been identified, and the system shall have been demonstrated to be capable of carrying out all identified operating modes through operation tests using the full-scale mock-up of the system. (TRL at the end of the project: Level 4)</p>
3) Development of Remote Maintenance Technology for Fuel Debris Retrieval Device	
<ul style="list-style-type: none"> Maintenance method study 	<p>Conceptual study shall have been completed on the plan of the layout and traffic line of main equipment and devices used for fuel debris removal operation. The basic feasibility of the maintenance method for equipment and devices used for fuel debris removal operation shall have been evaluated, and issues associated with the method shall have been identified along with approaches to address the issues. (TRL target at the end of the project: Level 3)</p>

Terminology (1/2)

No.	Terms	Definition
1	1F	Fukushima Daiichi Nuclear Power Station
2	PCV	Primary containment vessel
3	RPV	Reactor pressure vessel
4	CRD	Control rod drive
5	Operation floor	Operation floor
6	DSP	Dryer separator pool
7	SFP	Spent fuel pool
8	X-6 penetration	One of PCV piping openings
9	S/C	Suppression chamber
10	Jet deflector	Jet deflector
11	Inflate seal	Inflatable sealing device
12	Cell adapter	A member that connects the cell with the PCV
13	M/U	Mockup
14	BSW	Biological shielding wall
15	MCCI	Molten core concrete interaction
16	UC	Unit can (fuel debris collection container)
17	AWJ	Abrasive waterjet
18	Heating Ventilating Handling Unit (HVH)	Air conditioning unit
19	Material handling	Material handling

Terminology (2/2)

No.	Terms	Definition
1	TRL7	Practical application is complete.
2	TRL6	Developed methods and systems are tested in the actual environment.
3	TRL5	Real-scale prototypes are built, and validation tests are performed in a plant or lab using them, under conditions that simulate the actual environment.
4	TRL4	Functional tests are performed using testing mock-ups as part of the development and engineering processes.
5	TRL3	Development and engineering work is performed within the range of conventional experiences or their combination, or development and engineering work in new areas virtually without past experience.
6	TRL2	Development and engineering work is performed, and the required specifications are developed in areas where there is almost no applicable past experience.
7	TRL1	Basic requirements and necessary technologies are identified for the methods and systems to be developed and engineered.